

**LSOs**

- Aspen Medical . . . . . 466-468
- Bauerfeind . . . . . 469
- Becker Orthopedic . . . . . 469
- Bledsoe Brace™ . . . . . 470
- Breg® . . . . . 470-471
- BSN Medical . . . . . 471
- Corflex . . . . . 472
- Cybertech Medical™ . . . . . 472-475
- DeRoyal® . . . . . 475-477
- DonJoy (DJO) . . . . . 477-478
- Freeman Manufacturing . . . . . 478-480
- Hope Orthopedic . . . . . 480-481
- Medi USA . . . . . 482
- Optec . . . . . 482-484
- Orthocare Solutions . . . . . 485
- Orthomerica . . . . . 485-489
- Ossur Americas® . . . . . 490
- RCAI® . . . . . 491
- Truform® . . . . . 491
- Trulife . . . . . 491-492

**TLSOs**

- Aspen Medical . . . . . 492-494
- Becker Orthopedic . . . . . 495
- Breg . . . . . 495
- Cybertech Medical . . . . . 495
- DeRoyal . . . . . 496
- DonJoy (DJO) . . . . . 496
- Freeman Manufacturing . . . . . 497
- Hope Orthopedic . . . . . 497
- Medi USA . . . . . 497
- Optec . . . . . 498-499
- Orthomerica . . . . . 500-501
- Ossur Americas . . . . . 502
- RCAI . . . . . 503
- Truform . . . . . 503
- Trulife . . . . . 503

**Hyperextension**

- Becker Orthopedic . . . . . 504-505
- Bell-Horn® . . . . . 505
- Cybertech Medical . . . . . 506
- Florida Brace . . . . . 507-508
- Hope Orthopedic . . . . . 509
- Orthomerica . . . . . 510
- RCAI . . . . . 510
- Truform . . . . . 510
- Trulife . . . . . 511-513

**Supports**

- ProCare (DJO) . . . . . 513, 541
- Scott Specialties . . . . . 513, 541
- Trulife . . . . . 514
- Sacral and Lumbosacral Supports . . . . . 515-531
- Elasticized Lower Back Bracing . . . . . 531-537
- Industrial Supports . . . . . 537
- Abdominal Binders . . . . . 538-539
- Elasticized Rib Belts . . . . . 540
- SI Belts . . . . . 540-541

**Interfaces**

- Knit-Rite® . . . . . 542-543
- Trulife . . . . . 543

### Aspen Medical - Summit 631

- Conform Back Panel provides custom silhouette feel while administering direct pain relief to the lower back
- Ergonomic, comfortable fit to accommodate diverse anatomies and diagnosis
- Independent upper-zone and lower-zone tightening with SlickTrack® tightening system

Size	Circum.	Men's Pants Sizes	Women's Pants Sizes	Product No.
Small	26"-34"	26"-32"	2-6	<b>992520</b>
Medium	33"-42"	32"-38"	8-16	<b>992530</b>
Large	41"-51"	38"-48"	18-26	<b>992540</b>
XLarge	50"-60"	48"-58"	26-36	<b>992550</b>



Summit 631 - Front View



Summit 631 - Back View

### Summit 637

- Offers a therapeutic level of motion restriction while providing effective compression for the relief of low back pain
- Utilizes innovative materials and ergonomic design
- Contours comfortably to the vast majority of patient anatomies

Size	Circum.	Men's Pants Size	Women's Pants Size	Product No.
Small	26"-34"	26"-32"	2-6	<b>992320</b>
Medium	33"-42"	32"-38"	8-16	<b>992330</b>
Large	41"-51"	38"-48"	18-26	<b>992340</b>
XLarge	50"-60"	48"-58"	26-36	<b>992350</b>



Summit 637

### Contour™ LSO

- The brace is effective and comfortable, using the QuikDraw™ with Rigid Anterior Panel (RAP) as the platform
- The Contour™ LSO is modular with adjustable side and vertical panels, allowing the practitioner to fit a wide variety of patients while minimizing inventory
- Specifically designed with the progression of patient care in mind, the Contour™ LSO is a multiple orthotic system, which can be stepped down to the proven QuikDraw™ RAP

Size	Waist Circumference	Product No.	
		White	Black
X-Small	21"-27"	<b>990150</b>	<b>990050</b>
Small	26"-32"	<b>990151</b>	<b>990051</b>
Medium	31"-37"	<b>990152</b>	<b>990052</b>
Large	36"-42"	<b>990153</b>	<b>990053</b>
X-Large	41"-47"	<b>990154</b>	<b>990054</b>
2X-Large	46"-57"	<b>990155</b>	<b>990055</b>
Includes (1) 12" Contour back panel, (1) QuikDraw, (1) Regular RAP			



### Evergreen LSO LoPro

- 4 to 1 mechanical advantage, independent drawstrings offer direct compression to the lumbar spine for relief of low back pain
- Large pull tabs are easy to grab, locate and pull
- Breathable mesh fabric adds comfort for long-term wear

Size	Waist Circumference	Product No.
2X-Small	15"-21"	<a href="#">36-3101</a>
X-Small	21"-27"	<a href="#">36-3102</a>
Small	26"-32"	<a href="#">36-3103</a>
Medium	31"-37"	<a href="#">36-3104</a>
Large	36"-42"	<a href="#">36-3105</a>
X-Large	41"-47"	<a href="#">36-3106</a>
2X-Large	46"-57"	<a href="#">36-3107</a>



### Quikdraw PRO™ (Pain Relief Orthosis)

- Low profile restores functional mobility by providing compression for immediate pain relief

Size	Waist Circumference	Product No.	
		White	Black
X-Small	21"-27"	<a href="#">993080</a>	<a href="#">993081</a>
Small	26"-32"	<a href="#">993010</a>	<a href="#">993011</a>
Medium	31"-37"	<a href="#">993020</a>	<a href="#">993021</a>
Large	36"-42"	<a href="#">993030</a>	<a href="#">993031</a>
X-Large	41"-47"	<a href="#">993040</a>	<a href="#">993041</a>
2X-Large	46"-57"	<a href="#">993090</a>	<a href="#">993091</a>



### Quikdraw™ RAP (Rigid Anterior Panel) and Pad

- Restores functional mobility by providing compression for immediate pain relief

Size	RAP Pad	RAP Product No.	
	Product No.	White	Black
Regular RAP	<a href="#">993110</a>	<a href="#">993100</a>	<a href="#">993200</a>
Large RAP	<a href="#">993111</a>	<a href="#">993101</a>	<a href="#">993201</a>
Extension Panel Accessory	—	<a href="#">993060</a>	<a href="#">993061</a>



QuikDraw™ PRO
+
Rigid Anterior Panel (RAP)
=
QuikDraw™ RAP

### Quikdraw™ RAP Complete

- Includes (1) Quikdraw™ and (1) Regular RAP

Size	Waist Circumference	Product No.	
		Black	White
X-Small	21"-27"	995010	995011
Small	26"-32"	995020	995021
Medium	31"-37"	995030	995031
Large	36"-42"	995040	995041
X-Large	41"-47"	995050	995051
2X-Large	46"-57"	995060	995061



### Aspen LSO Low Profile

- When tightened using the LeverLatch mechanism, the brace firmly and evenly compresses the torso
- Enables patients to regain a significant degree of functional mobility
- The unique three-piece design, featuring symmetrical side panels, allows the practitioner to configure the orthosis so it can be tightened using either hand

Size	Back Panel Height	Waist Circum.	Product No.	Replacement Pads
Small	16"	26"-39"	990020	990025
Large	16"	36"-49"	990021	990026
X-Large	16"	46"-62"	990022	990027

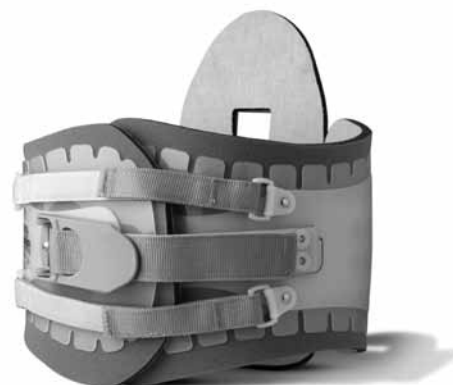

### Aspen LSO High Profile

- Provides motion restriction equivalent to that of the leading custom orthoses; forms a structurally rigid polyethylene cylinder that captures the trunk in a highly effective manner
- When tightened using the LeverLatch mechanism, the brace firmly and evenly compresses the torso
- Large lumbar window offers unobstructed vision and physical access for better patient care
- Provides maximum airflow for improved comfort

Size	Back Panel Height	Waist Circum.	Product No.	Replacement Pads
Short/Small	13"	26"-39"	990040	990045
Short/Large	13"	36"-49"	990041	990046
Tall/Small	16"	32"-47"	990060	990065
Tall/Large	16"	44"-59"	990061	990066

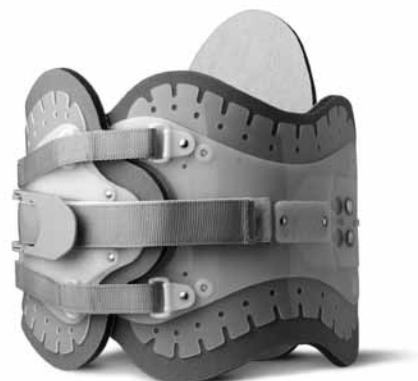

### Bauerfeind® - LumboPlus® Back Brace

- The LPT strap system (Low Power Tension) permits the application of considerable force against the body
- Skin-friendly, breathable, lightweight materials that provide circumferential support
- Practical finger pockets mean that the support can be fitted easily without the need to expend considerable effort
- Anatomically contoured abdominal pad provides improved abdominal cavity compression

**Indications:** Osteoporosis; Spondylolisthesis; Degenerative instabilities; Postoperative lumbar stabilization

Size	Body Circumference	Product No.
1	28" - 31"	<a href="#">12185300080001</a>
2	31" - 35"	<a href="#">12185300080002</a>
3	35" - 37"	<a href="#">12185300080003</a>
4	37" - 43"	<a href="#">12185300080004</a>
5	43" - 45"	<a href="#">12185300080005</a>
6	45" - 51"	<a href="#">12185300080006</a>

Loosely measure circumference below the waist



### Becker Orthopedic - Model 106 Knight LSO

- Controls lumbosacral flexion/extension, and lateral flexion
- Consists of two paraspinal bars and two lateral uprights attached inferiorly to a pelvic band and superiorly to a thoracic band
- Posteriorly, the inferior edge of the pelvic band is situated at the sacrococcygeal junctions for maximum leverage
- Abdominal support is secured to lateral uprights with corset lacing

Size	A	B	C	H	Product No.
X-Small	28"-30"	26"-28"	28"-30"	10"	<a href="#">106-XS</a>
Small	31"-33"	29"-32"	31"-33"	11"	<a href="#">106-S</a>
Medium	34"-36"	33"-35"	34"-36"	12"	<a href="#">106-M</a>
Large	37"-39"	36"-38"	37"-39"	13"	<a href="#">106-L</a>
X-Large	40"-42"	39"-42"	40"-44"	14"	<a href="#">106-XL</a>



### Model 108 Williams LSO

- Controls lumbosacral extension and lateral flexion
- Model 108 consists of pelvic and thoracic bands
- Two lateral uprights pivot on the thoracic band, but are not attached to the pelvic band
- The pelvic band is stabilized by a pair of oblique bars attached to the pelvic band and pivot on the lateral bars
- The abdominal support is laced to the lateral bars

Size	A	B	C	H	Product No.
X-Small	28"-30"	26"-28"	28"-30"	10"	<a href="#">108-XS</a>
Small	31"-33"	29"-32"	31"-33"	11"	<a href="#">108-S</a>
Medium	34"-36"	33"-35"	34"-36"	12"	<a href="#">108-M</a>
Large	37"-39"	36"-38"	37"-39"	13"	<a href="#">108-L</a>
X-Large	40"-42"	39"-42"	40"-44"	14"	<a href="#">108-XL</a>

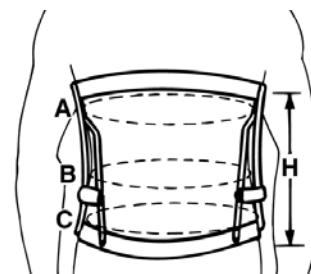

### Bledsoe Brace - Volare LS

- Anterior and posterior panels to unload spinal pressure for pain relief
- Zip line that provides a 5:1 mechanical advantage for easy one hand adjustment
- Posterior panel that extends from the L-1 to below the S-1 vertebra

**Indications:** Multiple level decompression; Lumbar laminectomy; Posterior lateral fusion and mechanical back pain

### Volare LS-xt

- Anterior/posterior panels to unload spinal pressure for pain relief
- Zip line that provides a 5:1 mechanical advantage for easy one hand adjustment
- Posterior panel that extends from sacrococcygeal junction to T-9 vertebra

**Indications:** Thoracolumbar injury; Revision surgery; Multi-level fusion; Mechanical Back Pain; Disc Herniation; Disc Degeneration; Lumbar Disectomy



Volare LS



Volare LS-xt

Size	Waist Circum.	Volare LS		Volare LS-xt	
		8"	10"	8"	10"
Small	25"-30"	AB017003	AB018003	AB022003	AB023003
Medium	30"-35"	AB017005	AB018005	AB022005	AB023005
Large	35"-40"	AB017007	AB018007	AB022007	AB023007
X-Large	40"-45"	AB017009	AB018009	AB022009	AB023009
2X-Large	45"-50"	AB017011	AB018011	AB022011	AB023011
3X-Large	50"-55"	AB017013	AB018013	AB022013	AB023013
4X-Large	56"-68	—	—	—	AB023015

### Breg - BOA Back Brace with Chairback

- Lightweight, latex-free modular construction is designed to support a three-stage treatment protocol
- Stage 1: involves post-operative use of the BOA with the rigid chairback piece, the flexible compression belt, and rigid anterior panel
- Stage 2: involves the removal of the chairback piece for compressive support during a progressive rehabilitation protocol
- Stage 3: involves removing the rigid anterior panel

**Indications:** Low back pain; low back sprains/strains; lumbar disc injury; Osteoporosis; Disc herniation and degeneration; Postoperative discectomy; IDET procedure; Spondylolithesis; Postoperative fusion; Spinal stenosis



Size	Waist Circumference	Product No.	
		8"	10"
Small	25"-30"	60022	60012
Medium	30"-35"	60023	60013
Large	35"-40"	60024	60014
X-Large	40"-45"	60025	60015
2X-Large	45"-50"	60026	60016
3X-Large	50"-55"	60027	60017

### BOA Classic 8" Back Brace

- Comprised of comfortable Airmesh® material, a flexible compression belt and a removable, moldable anterior panel; latex free
- Lacer Compression System utilizes a multiple teardrop channel design, high-tension cords and a single-pull strap to apply circumferential compression
- Midline opening eases pressure over the incision site, allowing for wound inspection without removing the orthosis
- Optional orthotic insert provides additional support and comfort while preventing slippage

**Indications:** Low back pain; Low back sprains/strains; Lumbar disc injury; Osteoporosis; Disc herniation and degeneration; Postoperative discectomy; IDET procedure; Spondylololthesis

Size	Waist Circumference	Product No.
Small	25" - 30"	<b>60042</b>
Medium	30" - 35"	<b>60043</b>
Large	35" - 40"	<b>60044</b>
X-Large	40" - 45"	<b>60045</b>
2X-Large	45" - 50"	<b>60046</b>
3X-Large	50" - 55"	<b>60047</b>



### BSN Medical - Core-Loc LSO

- Closure system with stabilizing Hydrostatic Lift
- Cooling 3-D spacer fabric and low profile design

Size	Waist Circumference	Product No.	
		Indented	Flat
Small	24"-28"	<b>A32-3504</b>	<b>A32-35043</b>
Medium	29"-33"	<b>A32-3505</b>	<b>A32-35053</b>
Large	34"-39"	<b>A32-3506</b>	<b>A32-35063</b>
X-Large	40"-44"	<b>A32-3507</b>	<b>A32-35073</b>
2X-Large	45"-49"	<b>A32-3508</b>	<b>A32-35083</b>
3X-Large	50"-55"	<b>A32-3509</b>	<b>A32-35093</b>
4X-Large	56"-60"	<b>A32-3510</b>	<b>A32-35103</b>
5X-Large	61"-65"	<b>A32-3511</b>	<b>A32-35113</b>



### Cinch-Loc LSO

- Closure system with stabilizing hydrostatic lift
- Cooling 3-D spacer fabric and low profile design
- Anatomically shaped back panel to match lordotic curve

Size	Waist Measurement	14" Panel	16" Panel	18" Panel
		(12"-17" Back Height)	(17"-19 1/2" Back Height)	(19 1/2"-22 1/2" Back Height)
Small	24"-28"	<b>7459901</b>	<b>7459902</b>	<b>7459903</b>
Medium	29"-33"	<b>7459905</b>	<b>7459906</b>	<b>7459907</b>
Large	34"-39"	<b>7459909</b>	<b>7459910</b>	<b>7459911</b>
X-Large	40"-44"	<b>7459913</b>	<b>7459914</b>	<b>7459915</b>
2X-Large	45"-49"	<b>7459917</b>	<b>7459918</b>	<b>7459919</b>
3X-Large	50"-55"	<b>7459921</b>	<b>7459922</b>	<b>7459923</b>
4X-Large	56"-60"	<b>7459925</b>	<b>7459926</b>	<b>7459927</b>
5X-Large	61"-65"	<b>7459929</b>	<b>7459930</b>	<b>7459931</b>



### Corflex - Disc Unloader Spinal Orthosis

- Reduces intradiscal pressure through circumferential compression
- Includes gel pack for cold/hot therapy
- Anatomically designed 12" posterior insert built with 5° of lordosis
- Constructed of soft breathable fabric with contoured rigid A.B.S. inserts, elastic double-pulls and contact closure support

**Indications:** Chronic or acute low back pain; Discogenic disc disease; Post-surgical application; Strains/sprains to lumbar muscles/ligaments and postural support

Size	Waist Measurement	Product No.
X-Small	25"-30"	<a href="#">35-4000</a>
Small	30"-35"	<a href="#">35-4001</a>
Medium	35"-40"	<a href="#">35-4002</a>
Large	40"-45"	<a href="#">35-4003</a>
X-Large	45"-50"	<a href="#">35-4004</a>
2X-Large	50"-55"	<a href="#">35-4005</a>
3X-Large	55"-60"	<a href="#">35-4006</a>
4X-Large	60"-65"	<a href="#">35-4007</a>



Front View



Back View

### Cybertech™ Medical - Protégé LSO

- A multifaceted modular spinal support that takes you from pre-op, initial post-op to a rehab progression stepdown system
- Allows for progressive rehab adaptability with removable/replaceable lateral, posterior and anterior panels

**Indications:** Post-operative stabilization following spinal fusion, laminectomy/laminotomy, foraminotomy, laproscopic disk replacement, IDET procedures and multi-level decompression; Burst fracture; Facet syndrome; Chronic and mechanical low back pain

Size	Waist Circumference	Lateral Panel	Product No.
Small	25"-30"	Standard	<a href="#">PLSO-NB-1</a>
Medium	30"-35"	Standard	<a href="#">PLSO-NB-2</a>
Large	35"-40"	Standard	<a href="#">PLSO-NB-3</a>
X-Large	40"-45"	Standard	<a href="#">PLSO-NB-4</a>
2X-Large	45"-50"	Large	<a href="#">PLSO-NB-5</a>
3X-Large	50"-55"	Large	<a href="#">PLSO-NB-6</a>



### Premium Plus

- Patient controls support level with one hand adjustment in one second for standing or sitting and puts the patient in great control for compliance; Semi rigid panels are heat moldable
- Mechanical advantage pulley system; Available in Black

Size	Waist Circumference	Product No.	
		8" Low-Profile	10" Standard
Small	25"-30"	<a href="#">EPRP-LB-1</a>	<a href="#">EPRP-SB-1</a>
Medium	30"-35"	<a href="#">EPRP-LB-2</a>	<a href="#">EPRP-SB-2</a>
Large	35"-40"	<a href="#">EPRP-LB-3</a>	<a href="#">EPRP-SB-3</a>
X-Large	40"-45"	<a href="#">EPRP-LB-4</a>	<a href="#">EPRP-SB-4</a>
2X-Large	45"-50"	<a href="#">EPRP-LB-5</a>	<a href="#">EPRP-SB-5</a>
3X-Large	50"-55"	<a href="#">EPRP-LB-6</a>	<a href="#">EPRP-SB-6</a>
4-5X-Large	56"-68"	—	<a href="#">EPRP-SB-7</a>





### TriMod System

- Rigid unibody frame provides superior posterior and lateral support
- 1-hand, 1-second adjustability provides patient convenience and control for greater compliance
- Interchangeable TriMod component sizes ensure proper patient fit
- Bariatric Brace version available, fitting girths 56"-68"
- Available in Black

Size	Waist Circumference	Product No.	
		8" Low Profile	10" Standard
Small	25"-30"	ETSP-LB-1	ETSP-SB-1
Medium	30"-35"	ETSP-LB-2	ETSP-SB-2
Large	35"-40"	ETSP-LB-3	ETSP-SB-3
X-Large	40"-45"	ETSP-LB-4	ETSP-SB-4
2X-Large	45"-50"	ETSP-LB-5	ETSP-SB-5
3X-Large	50"-55"	ETSP-LB-6	ETSP-SB-6
4-5X-Large	56"-68"	—	ETSP-SB-7



Anterior panel provides additional support



Bi-Mod System

### Bi-Mod System™

- Two braces in one: a chairback for post-op and an LSO for patient maintenance; simply remove LSO from chairback frame when less lateral support is required
- Combines rigid anterior-posterior medial lateral control with superior abdominal compression
- Pulley system provides 6 times more power to maximize compression
- Available in Black

Size	Waist Circumference	Product No.	
		8" Low Profile	10" Standard
Small	25"-30"	L0633L-S03	L0633-S03
Medium	30"-35"	L0633L-M03	L0633-M03
Large	35"-40"	L0633L-L03	L0633-L03
X-Large	40"-45"	L0633L-XL03	L0633-XL03
2X-Large	45"-50"	L0633L-XXL03	L0633-XXL03
3X-Large	50"-55"	L0633L-XXXL03	L0633-XXXL03
4-5XLarge	56"-58"	—	L0633-XXXXL03

### Mechanical Advantage Corset (MAC)

- Patented Mechanical Advantage Pulley System adjusts with the pull of one hand
- Lightweight mesh over wicking material allows breathability/comfort
- Up to 6" of closure for unmatched abdominal compression
- Height: Front - 6", Back - 10"
- Low profile available in Black only; Standard available in White only

Size	Waist Circumference	Product No.	
		Low Profile	Standard
Small	25"-30"	L0626B-S	L0626-S
Medium	30"-35"	L0626B-M	L0626-M
Large	35"-40"	L0626B-L	L0626-L
X-Large	40"-45"	L0626B-XL	L0626-XL
2X-Large	45"-50"	L0626B-XXL	L0626-XXL



### The "Original" Cybertech Brace

- Patented Mechanical Advantage Pulley System provides abdominal compression
- The patient can adjust the brace with one hand in one second for standing, sitting, walking or driving
- Single front fabric fastener makes the brace easy to don or doff
- Nylon mesh side panel maximizes air flow



Size	Waist Circum.	Low Profile 8" Product No.		Standard 10" Product No.	
		Black	White	Black	White
Small	25"-30"	LOW-S03	LOW-S01	STAN-S03	STAN-S01
Medium	30"-35"	LOW-M03	LOW-M01	STAN-M03	STAN-M01
Large	35"-40"	LOW-L03	LOW-L01	STAN-L03	STAN-L01
X-Large	40"-45"	LOW-XL03	LOW-XL01	STAN-XL03	STAN-XL01
2X-Large	45"-50"	LOW-XXL03	LOW-XXL01	STAN-XXL03	STAN-XXL01
3X-Large	50"-55"	LOW-XXXL03	LOW-XXXL01	STAN-XXXL03	STAN-XXXL01
4-5X-Large	55"-68"	LOW-XXXXL03	LOW-XXXXL01	STAN-XXXXL03	STAN-XXXXL01

### Comprehensive LSO

- Patented Mechanical Advantage Pulley System
- Interactive patient controlled lumbar and compression conformity
- Ergonomic covered plastic anterior panel
- Removable plush padding on both anterior and posterior panels

**Indications:** Lumbar mechanical back pain; Spinal stenosis; Spondylolisthesis; Facet Syndrome; Trauma; Pre- and Post-operative stabilization; Management protocol following Laminotomy; Foraminotomy; IDET procedures; Anterior Laprscopic fusion; Multilevel decompression

Size	Waist Circumference	Product No.
Small	30"-35"	TCLS-NB-2
Medium	35"-40"	TCLS-NB-3
Large	40"-45"	TCLS-NB-4
X-Large	45"-50"	TCLS-NB-5



### S.P.I.N.E.™ Plus

- Lightweight, breathable construction combined with contouring panels for increased comfort and support
- Quick, one-hand adjustment controls support level and comfort for standing or sitting
- Single front closure provides easy opening and closing

Size	Waist Circumference	Black Product No.	
		Plus	Sport
X-Small	20"-25"	ESFP-NB-0	—
Small	25"-30"	ESFP-NB-1	OM500-S
Medium	30"-35"	ESFP-NB-2	OM500-M
Large	35"-40"	ESFP-NB-3	OM500-L
X-Large	40"-45"	ESFP-NB-4	OM500-XL
2X-Large	45"-50"	ESFP-NB-5	OM500-XXL
3X-Large	50"-55"	ESFP-NB-6	OM500-XXXL



Available in Black only

### S.P.I.N.E. Brace

- Provides a powerful, dynamic approach to abdominal compression by utilizing the Mechanical Advantage Pulley System
- Patient can adjust the brace with one hand for standing, sitting, walking or driving
- Specially designed nylon mesh side panel maximizes air flow

Size	Waist Circumference	Black Product No.
X-Small	20"-25"	<b>SPINES-XS03</b>
Small	25"-30"	<b>SPINES-S03</b>
Medium	30"-35"	<b>SPINES-M03</b>
Large	35"-40"	<b>SPINES-L03</b>
X-Large	40"-45"	<b>SPINES-XL03</b>
2X-Large	45"-50"	<b>SPINES-XXL03</b>
3X-Large	50"-55"	<b>SPINES-XXXL03</b>



S.P.I.N.E. Brace  
Available in Black only



### Flex Plus

- Posterior panel and Flexible Pulley System in an intermediate brace that comfortably contours/conforms to patient's body structure
- 5:1 ratio, low-friction Flexible Pulley Systems provide powerful, smooth and easily-controlled compression
- Lightweight, breathable construction combines with contouring panels for increased comfort and support
- Quick, one-hand adjustment controls support level and comfort for standing or sitting

Size	Waist Circumference	Product No.	
		Gray 8"	Gray 10"
Small	25"-30"	<b>EGFP-LG-1</b>	<b>EGFP-SG-1</b>
Medium	30"-35"	<b>EGFP-LG-2</b>	<b>EGFP-SG-2</b>
Large	35"-40"	<b>EGFP-LG-3</b>	<b>EGFP-SG-3</b>
X-Large	40"-45"	<b>EGFP-LG-4</b>	<b>EGFP-SG-4</b>
2X-Large	45"-50"	<b>EGFP-LG-5</b>	<b>EGFP-SG-5</b>
3X-Large	50"-55"	<b>EGFP-LG-6</b>	<b>EGFP-SG-6</b>

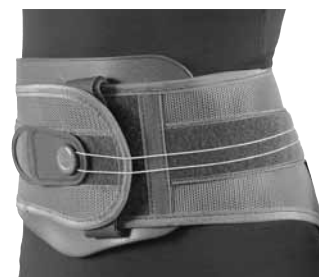

Flex Plus Front



Flex Plus Back

### DeRoyal - Prolign® Lumbar Orthosis

- Constructed of hook receivable material with soft breathable liner that wicks away moisture to help prevent skin breakdown
- Dual dynamic closure system provides instant full range adjustment and maximum compression
- Rigid anterior insert provides support to intra-abdominal and viscera region helping to unload the spine under gravitational load

Size	Waist Circumference	Product No.	
		15°	25°
X-Small	25" - 30"	<b>13501004</b>	<b>13500004</b>
Small	30" - 35"	<b>13501005</b>	<b>13500005</b>
Medium	35" - 40"	<b>13501006</b>	<b>13500006</b>
Large	40" - 45"	<b>13501007</b>	<b>13500007</b>
X-Large	45" - 50"	<b>13501008</b>	<b>13500008</b>
2X-Large	50" - 55"	<b>13501009</b>	<b>13500009</b>



### Ultraalign® + Lumbar Sacral Orthosis

- Constructed of hook receivable material with soft breathable liner that provides a cooler, lighter fit
- Dual dynamic closure system allows infinite adjustability and maximum compression
- Combines heat-moldable plastic inserts (anterior, posterior, lateral) for rigid support
- Available in 0°, 15° or 25° lordosis

**Indications:** Post-operative lumbar fusion; Laminectomy or disectomy; Lumbar compression fractures; Degenerative disc disease; Osteoporosis; Spondylolysis; Spondylolysis; Spinal stenosis; Facet syndrome



Size	Product No.		
	0° Lordosis	15° Lordosis	25° Lordosis
<b>Non-Tapered</b>			
Small	<b>UPL1330-0</b>	<b>UPL1330-15</b>	<b>UPL1330-25</b>
Medium	<b>UPL1430-0</b>	<b>UPL1430-15</b>	<b>UPL1430-25</b>
Large	<b>UPL1530-0</b>	<b>UPL1530-15</b>	<b>UPL1530-25</b>
X-Large	<b>UPL1630-0</b>	<b>UPL1630-15</b>	<b>UPL1630-25</b>
2X-Large	<b>UPL1730-0</b>	<b>UPL1730-15</b>	<b>UPL1730-25</b>
<b>Tapered</b>			
Small	<b>UPL2330-0</b>	<b>UPL2330-15</b>	<b>UPL2330-25</b>
Medium	<b>UPL2430-0</b>	<b>UPL2430-15</b>	<b>UPL2430-25</b>
Large	<b>UPL2530-0</b>	<b>UPL2530-15</b>	<b>UPL2530-25</b>
X-Large	<b>UPL2630-0</b>	<b>UPL2630-15</b>	<b>UPL2630-25</b>
2X-Large	<b>UPL2730-0</b>	<b>UPL2730-15</b>	<b>UPL2730-25</b>
<b>Low-Profile Tapered</b>			
Small	—	<b>UPLP2330-15</b>	<b>UPLP2330-25</b>
Medium	—	<b>UPLP2430-15</b>	<b>UPLP2430-25</b>
Large	—	<b>UPLP2530-15</b>	<b>UPLP2530-25</b>
X-Large	—	<b>UPLP2630-15</b>	<b>UPLP2630-25</b>
2X-Large	—	<b>UPLP2730-15</b>	<b>UPLP2730-25</b>
<b>Mid-Profile Non-Tapered</b>			
Small	—	<b>UPMP1330-15</b>	—
Medium	—	<b>UPMP1430-15</b>	—
Large	—	<b>UPMP1530-15</b>	—
X-Large	—	<b>UPMP1630-15</b>	—
2X-Large	—	<b>UPMP1730-15</b>	—

Sizing Guide			
Size	Xyphoid	Waist	Trochanter
<b>Non-Tapered</b>			
Small	31"-35"	31"-35"	31"-35"
Medium	34"-38"	32"-38"	34"-39"
Large	37"-41"	35"-41"	38"-42"
X-Large	38"-45"	38"-45"	38"-45"
2X-Large	45"-53"	45"-53"	45"-53"
<b>Tapered</b>			
Small	25"-31"	25"-31"	27"-33"
Medium	28"-35"	29"-36"	32"-38"
Large	32"-38"	32"-38"	35"-41"
X-Large	35"-42"	36"-42"	38"-46"
2X-Large	40"-46"	39"-47"	43"-49"

**Circumferential Measurements:**

- 1. Xyphoid:** 1" below tip of breast bone or xyphoid process
- 2. Waist:** Around navel or waist
- 3. Trochanter:** Around fullest area of trochanter or hips

### Prolign® Pro Lumbar Orthosis

- Dual, dynamic closure system provides infinite adjustment and maximum compression
- Rigid anterior insert provides support to the intra-abdominal and viscera region helping to unload the spine under gravitational load
- Posterior plastic insert (spot moldable) helps to maintain neutral sagittal alignment while maximizing support of abdominal structures
- Plastic D-rings for ease of application and removal

**Indications:** Post-operative lumbar immobilization; Chronic low back pain; Lumbar muscle weakness; Lumbar strains and sprains; Mechanical or discogenic disc disease; Postural support; Degenerative disc disease; IDET procedure; Spinal blocks

Size	Waist Circumference	Product No.
X-Small	25" - 30"	<b>150-01</b>
Small	30" - 35"	<b>150-02</b>
Medium	35" - 40"	<b>150-03</b>
Large	40" - 45"	<b>150-04</b>
X-Large	45" - 50"	<b>150-05</b>
2X-Large	50" - 55"	<b>150-06</b>



Back View

### DonJoy (DJO) - Back Bracing

- Simple hook and loop closure for ease of application and removal
- Proprietary Mechanical Pulley System panels allow for a smooth and uniform compression
- Breathable interior spacer fabric with outer mesh allows heat to escape without compromising brace performance
- DonJoy Lite is a lighter version of the Low Profile, without the rigid anterior panel, providing support for mild lower back pain, from L1-L5

**Indications:** Low back pain; Low back sprains/strains; Lumbar disc displacement; Osteoporosis; Disc herniation and degeneration; Post-operative laminectomy; Post-operative disectomy; IDET procedure; Spondylolisthesis; Post-operative fusion; Spinal stenosis

Size	8" Low Profile	9" Lite	10" Regular
Small	<b>11-1569-2</b>	<b>11-1570-2</b>	<b>11-1568-2</b>
Medium	<b>11-1569-3</b>	<b>11-1570-3</b>	<b>11-1568-3</b>
Large	<b>11-1569-4</b>	<b>11-1570-4</b>	<b>11-1568-4</b>
X-Large	<b>11-1569-5</b>	<b>11-1570-5</b>	<b>11-1568-5</b>
2X-Large	<b>11-1569-6</b>	—	<b>11-1568-6</b>
3X-Large	<b>11-1569-7</b>	—	<b>11-1568-7</b>

#### Waist Measurement Sizing Charts

Size	Regular and Low Profile	Lite
Small	25"-30"	26"-32"
Medium	30"-35"	32"-38"
Large	35"-40"	38"-43"
X-Large	40"-45"	43"-48"
2X-Large	45"-50"	—
3X-Large	50"-55"	—



Lite Back



### BOA LSO with Chairback

- Rigid anterior and posterior panels are constructed of heat gun moldable polyblend plastic customizable to the patient for fluctuations in weight or distension
- Easy to use compression technology with hook and loop closures
- Maximum comfort for patient compliance with the light weight and low profile construction
- Lordotic foam inserts available in varying degrees for comfort and increased lordosis



BOA with Chairback

Size	Waist Measurement	Product No.
Small	25"-30"	<b>11-1562-2</b>
Medium	30"-35"	<b>11-1562-3</b>
Large	35"-40"	<b>11-1562-4</b>
X-Large	40"-45"	<b>11-1562-5</b>
2X-Large	45"-50"	<b>11-1562-6</b>
3X-Large	50"-55"	<b>11-1562-7</b>

### Freeman Manufacturing - Model 561 Men's Cinch-It™ Orthosis with Rigid Anterior and Posterior Panels

- Designed for patients with arthritic hands lacking dexterity to use conventional snap-button/hook-and-eye closure
- Above Waist: Front - 1 1/2", Back - 4"
- Below Waist: Front - 7 1/2", Back - 10"
- Front Closure: Three 1 1/2" wide cinch pull adjustable straps
- Adjustment: Two-pull side lace
- Elastic Releases: At top and groin
- Even hip sizes: 30"-54"; Hip Development: 4"
- Materials: White canvas
- Replace ? with hip measurement



Model 561 Front



Model 561 Back

Product No. **561-?**

### Model 565 Women's Cinch-It™ Orthosis with Rigid Anterior and Posterior Panels

- Designed for patients with arthritic hands lacking dexterity to use conventional hook-and-eye closure
- Above Waist: Front - 1 1/2", Back - 1 1/2"
- Below Waist: Front - 7 1/2", Back - 10"
- Adjustment: Two-pull side lace
- Front Closure: Three 1 1/2" wide cinch pull adjustable straps
- Elastic Releases: At top and bottom
- Hose supporters, order Model HS1
- Even hip sizes: 30"-56"; Hip Development: 6"
- Materials: White polyester/cotton
- Replace ? with hip measurement



Model 565 Front



Model 565 Back

Product No. **565-?**

### Combo™ LSO Brace

- Constructed of firm polyethylene foam exterior over soft foam interface with a rigid 2024-T3 aluminum frame sandwiched between the layers
- Combines the rigidity of an aluminum frame chair-back brace with the flexibility of a thermoplastic body jacket
- Adjustable hook-and-pile side strap and front strap closure
- 12" back length

Size	Hip Circumference	Product No.
Small	32"-34"	<b>8121-12S</b>
Medium	36"-38"	<b>8121-12M</b>
Large	40"-42"	<b>8121-12L</b>
X-Large	44"-46"	<b>8121-12XL</b>
2X-Large	48"-50"	<b>8121-12XXL</b>



LSO's

### Combo™ LSO Sacro-Form™ with Elastic Front

- Similar to Model 8121, but with lightweight plastic (instead of aluminum frame) encased between soft foam liner and firm foam exterior
- The Sacro-Form™ has an elastic front closure with a 5" heavy elastic compression band
- Elastic front secure has plastic reinforcement with 12" back length

Size	Hip Circumference	Product No.
Small	28"-32"	<b>8121E-S</b>
Medium	34"-38"	<b>8121E-M</b>
Large	40"-44"	<b>8121E-L</b>
X-Large	46"-48"	<b>8121E-XL</b>
2X-Large	50"-52"	<b>8121E-XXL</b>



### Spinalite Chairback Brace

- Made of Kydex®, 40% lighter and 33% thinner than metal braces
- Mildly flexible, Spinalite braces are preshaped, but can be easily modified with a heat gun
- A closed cell foam lining adds comfort and assures greater patient tolerance over a prolonged period of wear
- Complete with slide buckle and truss hook front

Size	Hip Measurement	Brace Height	Product No.
Small	29"-32"	11 <sup>1</sup> / <sub>2</sub> "	<b>9120-S</b>
Medium	33"-36"	12 <sup>1</sup> / <sub>2</sub> "	<b>9120-M</b>
Large	37"-40"	13"	<b>9120-L</b>
X-Large	41"-44"	13"	<b>9120-XL</b>



### Spina® II LSO (4-post chairback)

- Super-lightweight Kydex frame with 3/8" pile-covered foam liner
- Helps reduce lordosis through general abdominal compression while providing AP and ML stability
- Liner attaches by hook-and-pile contact
- Height: Front - 9<sup>1</sup>/<sub>2</sub>"; Back - 12"

Size	Hip Measurement	Product No.
Small	30"-35"	<b>9121-S</b>
Medium	36"-41"	<b>9121-M</b>
Large	42"-47"	<b>9121-L</b>
X-Large	48"-53"	<b>9121-XL</b>



### Four-Post Chairback Brace

- Fully padded aluminum frame is covered with tan leather on the outside, cream leather on the inside
- Posterior height is 12"
- Corset front of white canvas is laced to lateral uprights and has alternating strap and truss-hook closure
- Front is padded with inner lining of foam; Provides AP and ML control

Size	Hip Measurement	Product No.
Small	30"-32"	<b>8152-S</b>
Medium	34"-36"	<b>8152-M</b>
Large	38"-40"	<b>8152-L</b>
X-Large	42"-44"	<b>8152-XL</b>



### Hope Orthopedic - Ninja Pro™

- 6X mechanical advantage; Single pull D-ring cinching strap
- MRI compatible
- Front Inserts: Standard Polyethylene (MPE), Molded Kydex, Extender-Ready (KYD), Pendulous (PKYD)
- Quick adjust lordosis: 5°, 15° and 25°

**Indications:** Chronic back pain; Degenerative disc disease; Herniated or bulging disc; Kyphosis; Ligament strain/sprain; Post-laminectomy; Spinal stabilization; Spinal stenosis; Spondylolisthesis; Spondylolysis; Osteoporosis

Model No. **NJPRO**

Sizing Chart						
Size	Waist	Low Profile (Front)	Std. Profile (Front)	Belt (Back)	LSM (Back)	PRO (Back)
Small	28"-33"	6"	7 <sup>1</sup> / <sub>2</sub> "	9"	10 <sup>1</sup> / <sub>2</sub> "	14 <sup>1</sup> / <sub>2</sub> "
Medium	33"-38"	6"	7 <sup>1</sup> / <sub>2</sub> "	9"	10 <sup>1</sup> / <sub>2</sub> "	14 <sup>1</sup> / <sub>2</sub> "
Large	38"-43"	6"	7 <sup>1</sup> / <sub>2</sub> "	9"	10 <sup>1</sup> / <sub>2</sub> "	14 <sup>1</sup> / <sub>2</sub> "
X-Large	43"-48"	6"	7 <sup>1</sup> / <sub>2</sub> "	9"	10 <sup>1</sup> / <sub>2</sub> "	14 <sup>1</sup> / <sub>2</sub> "
2X-Large	48"-54"	6 <sup>1</sup> / <sub>2</sub> "	8"	9"	10 <sup>1</sup> / <sub>2</sub> "	14 <sup>1</sup> / <sub>2</sub> "
3X-Large	54"-60"	6 <sup>1</sup> / <sub>2</sub> "	8"	9"	10 <sup>1</sup> / <sub>2</sub> "	14 <sup>1</sup> / <sub>2</sub> "
4X-Large	60"-65"	6 <sup>1</sup> / <sub>2</sub> "	8"	9"	10 <sup>1</sup> / <sub>2</sub> "	14 <sup>1</sup> / <sub>2</sub> "
5X-Large	65"-73"	6 <sup>1</sup> / <sub>2</sub> "	8"	9"	10 <sup>1</sup> / <sub>2</sub> "	14 <sup>1</sup> / <sub>2</sub> "



Ninja Pro front view



Ninja Pro back view

#### Ordering Example

Model . . . . . **NJPRO**  
 Profile . . . . . **SP**  
 Size . . . . . **SM**  
 Front Insert . . . . . **MPE**  
 Lordosis . . . . . **15**  
**NJRPO-SP-SM-MPE-15**



### OrthoLux LSO

- Breathable, moisture wicking, tri-laminate foam
- Corrugated and padded posterior Kydex® inserts
- Straps with D-rings for easy donning
- Front plate pre-drilled for Extender attachment

**Indications:** Chronic back pain; Compression fracture; Degenerative disc disease; Herniated or bulging disc; Kyphosis; Ligament strain/sprain; Post-laminectomy; Spinal stabilization; Spinal stenosis; Spondylolisthesis; Spondylolysis; Osteoporosis

Model No. **ORT-LSO**

Ordering Information		
Size	Front	Lordosis
SM (Small)	SP (standard height)	0
MD (Medium)	MP (mid-profile height)	7
LG (Large)	LP (low-profile height)	15
XL (X-Large)	PS (pendulous, standard)	25
2X (2X-Large)	PM (pendulous, mid)	35
3X (3X-Large)	PL (pendulous, low)	—
4X (4X-Large)	—	—

Accessories	
Description	Product No.
Extension Panel, Adds up to 8" Circumference	<b>OP-EXT-PNL</b>
Sternal Extender, Fixed	<b>EXT-STF-FXD-BLK-WSC</b>

Sizing Chart			
Size	Hip	Waist	Rib
Small	29"-35"	28"-34"	28"-34"
Medium	32"-39"	30"-37"	30"-36"
Large	36"-42"	34"-42"	34"-40"
X-Large	39"-47"	38"-45"	38"-45"
XX-Large	45"-52"	43"-51"	43"-51"
3X-Large	51"-56"	47"-55"	47"-55"
4X-Large	57"-63"	53"-61"	53"-61"

### LumboLux™

- Posterior profile: Short (SH), Standard (ST) or Tall (TL)
- 0, 7, 15 or 25 degrees lordosis
- Front Pocket separate from belt - always centered
- Front & back inserts - molded and remoldable (Kydex)
- Available in Black or White

Model No. **LX**

Anterior Profile	Front Height		Back Height	
	Fabric	Insert	Fabric	Insert
Short	5"	4"	8"	7"
Standard	6"	5"	10"	9"
Tall	7"	6"	12"	11"



OrthoLux LSO

Ordering Example	
Model . . . . .	<b>ORT-LSO</b>
Sex . . . . .	<b>U</b>
Size . . . . .	<b>LG</b>
Front . . . . .	<b>SP</b>
Lordosis . . . . .	<b>15</b>
<b>ORT-LSO-U-LG-SP-15</b>	



LumboLux

Size	Waist
Small	26"-32"
Medium	30"-37"
Large	34"-41"
X-Large	38"-47"
XX-Large	44"-54"
3X-Large	50"-62"
4X-Large*	56"-68"

\*Only available for ST and TL profiles

Ordering Example	
Model . . . . .	<b>LX</b>
Color . . . . .	<b>BL</b>
Size . . . . .	<b>LG</b>
Profile . . . . .	<b>ST</b>
Lordosis . . . . .	<b>15</b>
<b>LX-BL-LG-ST-15</b>	

### Medi USA - Lumbamed® Action LSO

- Breathable, moisture-transporting fabric enhances patient comfort
- Anatomically designed support
- Rigid split panel design supports torso while relieving pressure on vertebral processes increasing patient comfort and compliance
- Available in Dark Gray
- Measurement: Circumference taken at waist to girth size

**Indications:** Postoperative stabilization; Chronic lumbar pain/instability; Degenerative disc disease; Disc herniation; Lumbago in disc protrusion; Post-vertebral disc surgery; Muscular instability and spasm; Spinal stenosis and spondylosis; Lumbar pain from osteoporosis



Size	Size Range	Product No.
<b>Standard (average patient height: 5'10")</b>		
X-Small	24"-28"	<b>65851</b>
Small	28 <sup>1</sup> / <sub>2</sub> "-33 <sup>1</sup> / <sub>2</sub> "	<b>65852</b>
Medium	34"-40"	<b>65853</b>
Large	40"-45 <sup>1</sup> / <sub>2</sub> "	<b>65854</b>
X-Large	45 <sup>1</sup> / <sub>2</sub> "-51"	<b>65855</b>
2X-Large	51 <sup>1</sup> / <sub>2</sub> "-57 <sup>1</sup> / <sub>2</sub> "	<b>65856</b>
<b>Low Profile (average patient height: 5'4")</b>		
X-Small	24"-30"	<b>65751</b>
Small	27"-34"	<b>65752</b>
Medium	33"-39"	<b>65753</b>
Large	38"-44"	<b>65754</b>
X-Large	43"-49"	<b>65755</b>
2X-Large	48"-55"	<b>65756</b>



### Optec - Stealth Xtreme™ LSO

- Combines the Stealth with a rigid polyethylene posterior shell to provide support laterally and from sacrococcygeal junction to T9 vertebra
- Panels contour to your patient's shape and lordotic curve
- Offers various levels of compression which can be regulated by your patient

**Indications:** Burst Fx; Post-op spinal lumbar stabilization; Chronic back pain; Compression Fx; Degenerative; Herniated or bulging disc; Spinal instability; Post-op disc surgery; Spondylolysis; Spondylolisthesis; Spinal stenosis; Facet syndrome; Tumors; Inflammation; Post-op laminectomy



Stealth Xtreme 2 - front view

Size	Waist Measurement	Product No.	
		Xtreme 2	Xtreme 4
Small	23"-30"	<b>STX2BSM</b>	<b>STX4BSM</b>
Medium	27"-34"	<b>STX2BMD</b>	<b>STX4BMD</b>
Large	32"-40"	<b>STX2BLG</b>	<b>STX4BLG</b>
X-Large	37"-44"	<b>STX2BXL</b>	<b>STX4BXL</b>
2X-Large	41"-48"	<b>STX2B2X</b>	<b>STX4B2X</b>
3X-Large	45"-52"	<b>STX2B3X</b>	<b>STX4B3X</b>
4X-Large	49"-56"	<b>STX2B4X</b>	<b>STX4B4X</b>



Stealth Xtreme 2 - back view

### Stealth X™ LSO

- Four panel design provides saggitalcorronal support
- Durable, flexible, closure system with polymer straps provides additional reinforcement and support to the posterior
- Combines the benefits of a post-op and rehab brace
- Available in Black

**Indications:** Burst Fx; Post-op spinal lumbar stabilization; Chronic back pain; Compression Fx; Degenerative; Herniated or bulging disc; Spinal instability; Post-op disc surgery; Spondylolysis; Spondylolisthesis; Spinal stenosis; Facet syndrome; Tumors; Inflammation; Post-op laminectomy



Stealth X LSO - front view



Stealth X LSO - back view

Size	Waist Measurement	Product No.
Small	23"-30"	<b>ST4XBSM</b>
Medium	27"-34"	<b>ST4XBMD</b>
Large	32"-40"	<b>ST4XBLG</b>
X-Large	37"-44"	<b>ST4XBXL</b>
2X-Large	41"-48"	<b>ST4XB2X</b>
3X-Large	45"-52"	<b>ST4XB3X</b>
4X-Large	49"-56"	<b>ST4XB4X</b>

### Stealth LSO

- Posterior interlocking system, polymer panels and flexible stays provide unparalleled support and immobilization
- In progressive stages of recovery, the polymer panels can be removed for comfortable daily support
- 2-strap Design - Anterior height: 6<sup>1</sup>/<sub>2</sub>", Posterior height: 14<sup>1</sup>/<sub>2</sub>"
- 4-strap Design - Anterior height: 7<sup>1</sup>/<sub>2</sub>", Posterior height: 14<sup>1</sup>/<sub>2</sub>"

**Indications:** Burst Fx; Post-op spinal lumbar stabilization; Chronic back pain; Compression Fx; Degenerative; Herniated or bulging disc; Spinal instability; Post-op disc surgery; Spondylolysis; Spondylolisthesis; Spinal stenosis; Facet syndrome; Tumors; Inflammation; Post-op laminectomy



Size	Waist Measurement	Product No.	
		Standard	Low-Profile
<b>Black Stealth LSO</b>			
Small	23"-30"	<b>STLSSM</b>	<b>STLPSM</b>
Medium	27"-34"	<b>STLSMD</b>	<b>STLPMD</b>
Large	32"-40"	<b>STLSLG</b>	<b>STLPLG</b>
X-Large	37"-44"	<b>STLSXL</b>	<b>STLPXL</b>
2X-Large	41"-48"	<b>STLSXXL</b>	<b>STLP2XL</b>
3X-Large	45"-52"	<b>STLSXXXL</b>	<b>STLP3XL</b>
4X-Large	49"-56"	<b>STLSXXXXL</b>	<b>STLP4XL</b>
<b>White Stealth LSO</b>			
Small	23"-30"	<b>STLSWSM</b>	<b>STLPWSM</b>
Medium	27"-34"	<b>STLSWMD</b>	<b>STLPWMD</b>
Large	32"-40"	<b>STLSWLG</b>	<b>STLPWLG</b>
X-Large	37"-44"	<b>STLSWXL</b>	<b>STLPWXL</b>
2X-Large	41"-48"	<b>STLSWXXL</b>	<b>STLPW2XL</b>
3X-Large	45"-52"	<b>STLSWXXXL</b>	<b>STLPW3XL</b>
4X-Large	49"-56"	<b>STLSWXXXXL</b>	<b>STLPW4XL</b>



### VertaMax™ LSO

- Provides anterior-posterior support, abdominal support, anatomic fit, ease of donning and doffing and soft comfort
- Abdominal compression can be increased or decreased with the fastening tabs
- Adjustable anterior and posterior plastic panels contour and conform to patients of shapes, sizes and lordotic curves with no heat molding necessary

**Indications:** Degenerative, herniated or bulging disc; Spondylolysis; Spondylolisthesis; Spinal stenosis; Facet syndrome; Tumors; Inflammation; Chronic back pain; Spinal instability; Lumbago



VertaMax LSO - front view



VertaMax LSO - back view

Size	Waist Measurement	Product No.	
		Beige	Black
2X-Small/X-Small	22"-30 <sup>1</sup> / <sub>2</sub> "	VMBG2S/XS	VMLSD2S/XS
Small/Medium	28"-38 <sup>1</sup> / <sub>2</sub> "	VMBGSM/MD	VMLSDSM/MD
Large/X-Large	36"-46 <sup>1</sup> / <sub>2</sub> "	VMBGLG/XL	VMLSDLG/XL
2X-Large/3X-Large	44"-54 <sup>1</sup> / <sub>2</sub> "	VMBG2X/3X	VMLSD2X/3X
4X-Large/5X-Large	52"-60 <sup>1</sup> / <sub>2</sub> "	VMBG4X/5X	VMLSD4X/5X

### Oasis LSO

- Hook and loop closure system secures itself directly to the front rigid panel
- The adjustable strap length and D-rings provide a custom fit and secure grip essential for easy donning and doffing
- LSO - Anterior height: 9", Posterior height: 14<sup>1</sup>/<sub>2</sub>"
- LSO LP - Anterior height: 7<sup>1</sup>/<sub>2</sub>", Posterior height: 14<sup>1</sup>/<sub>2</sub>"

**Indications:** Burst FX, Post Op Spinal Lumbar Stabilization; Chronic Back Pain; Compression FX; Degenerative, Herniated or Bulging Disc; Spinal Instability; Post-Op Disc Surgery; Spondylolysis; Spondylolisthesis; Spinal Stenosis; Facet syndrome; Tumors; Inflammation; Post-Op Laminectomy



Oasis LSO Low-Profile



Oasis LSO

Size	Waist Measurement	Product No.	
		Low Profile	Regular
X-Small	26"-32"	OALPXS	OALSXS
Small	30"-36"	OALPSM	OALSSM
Medium	34"-40"	OALPMD	OALSMD
Large	38"-44"	OALPLG	OALS LG
X-Large	42"-48"	OALPXL	OALSXL
2X-Large	46"-52"	OALP2X	OALS2X
3X-Large	50"-56"	OALP3X	OALS3X

### Orthocare Solutions - M-Spine

- 8 flexible steel inner stays covered with plastic
- Versatile and lightweight user friendly adjustable locking system
- Breathable materials and cotton
- Front panel height: 2-Strap: 6<sup>3</sup>/<sub>4</sub>"; 3-Strap: 8"

Size	Hip Measurement	Product No.	
		2-Strap	3-Strap
Small	24"-31 <sup>1</sup> / <sub>2</sub> "	<b>M584 S</b>	<b>M574 S</b>
Medium	29 <sup>1</sup> / <sub>2</sub> "-35 <sup>1</sup> / <sub>2</sub> "	<b>M584 M</b>	<b>M574 M</b>
Large	33 <sup>1</sup> / <sub>2</sub> "-43 <sup>1</sup> / <sub>2</sub> "	<b>M584 L</b>	<b>M574 L</b>
X-Large	41 <sup>1</sup> / <sub>2</sub> "-47"	<b>M584 XL</b>	<b>M574 XL</b>
2X-Large	47"-55"	<b>M584 2XL</b>	<b>M574 2XL</b>
3X-Large	55" and up	<b>M584 3XL</b>	<b>M574 3XL</b>



### Orthomerica - Ventura™ Spinal Brace

- Easy to fit and simple for the patient to don and doff
- Provides controlled levels of stability by featuring easily removable rigid plastic components

**Indications:** Post-operative laproscopic disk replacement; Post-operative IDET procedures; Post-operative lumbar laminectomy; Post-operative spinal fusion; Chronic low back pain; Mechanical back pain with activities of daily living; When spinal control of extension and flexion is desired/required



Ventura Front View

Size	Fits Waists	Product No.			
		Ventura 626	Ventura 627	Ventura 631	Ventura 637
X-Small	26"-31"	<b>3259.626</b>	<b>3259.627</b>	<b>3259.631</b>	<b>3259.637</b>
Small	31"-36"	<b>3260.626</b>	<b>3260.627</b>	<b>3260.631</b>	<b>3260.637</b>
Medium	36"-41"	<b>3261.626</b>	<b>3261.627</b>	<b>3261.631</b>	<b>3261.637</b>
Large	41"-46"	<b>3262.626</b>	<b>3262.627</b>	<b>3262.631</b>	<b>3262.637</b>
X-Large	46"-51"	<b>3263.626</b>	<b>3263.627</b>	<b>3263.631</b>	<b>3263.637</b>
2X-Large	51"-56"	<b>3264.626</b>	<b>3264.627</b>	<b>3264.631</b>	<b>3264.637</b>
3X-Large	56"-61"	<b>3265.626</b>	<b>3265.627</b>	<b>3265.631</b>	<b>3265.637</b>
4X-Large	61"-66"	<b>3266.626</b>	<b>3266.627</b>	<b>3266.631</b>	<b>3266.637</b>



Ventura Back View

Ventura Components							
Size	Shell Posterior Height	Ventura Builds	Fits Waists	With Belt Component	Anterior Panel	631 Posterior Panel	637 Posterior Panel
X-Small	9"	626	26"-66"	<b>3259.626-3266.626</b>	—	—	—
Small	9"	627	26"-66"	<b>3259.626-3266.626</b>	<b>XB10</b>	—	—
Medium	14"	631	26"-36"	<b>3259.626-3260.626</b>	<b>XB10</b>	<b>XB04</b>	—
Large	15 <sup>1</sup> / <sub>2</sub> "	631	36"-46"	<b>3261.626-3262.626</b>	<b>XB10</b>	<b>XB05</b>	—
X-Large	16 <sup>1</sup> / <sub>2</sub> "	631	46"-66"	<b>3263.626-3266.626</b>	<b>XB10</b>	<b>XB06</b>	—
2X-Large	12"	637	26"-36"	<b>3259.626-3260.626</b>	<b>XB10</b>	—	<b>XB07</b>
3X-Large	14 <sup>1</sup> / <sub>2</sub> "	637	36"-46"	<b>3261.626-3262.626</b>	<b>XB10</b>	—	<b>XB08</b>
4X-Large	15 <sup>1</sup> / <sub>2</sub> "	637	46"-66"	<b>3263.626-3266.626</b>	<b>XB10</b>	—	<b>XB09</b>

### California Laguna™ Spinal Brace

- A completely modular, customizable brace that's easy to fit, yet simple for the patient to tighten, don and doff
- Interchangeable posterior panels conform to the curvature of the back, providing support while maximizing patient comfort

**Indications: Belt:** Spinal stenosis; Chronic low back pain; Degenerative spinal pathologies; **Rigid Panels:** Post-operative laproscopic disk replacement; Post-operative lumbar laminectomy; Post-operative spinal fusion; Mechanical back pain with activities of daily living; When spinal control of extension and flexion is desired/required



Laguna Builds	Shell Posterior Height	Waist/Shell Relationship	Laguna Build Components					Complete Orthosis
			Belt	Anterior Panel	631 Posterior Panel	637 Posterior Panel		
626	9"	26"-66"	<b>XB7800</b>	—	—	—	<b>XB7800</b>	
627	9"	26"-66"	<b>XB7800</b>	<b>XB10</b>	—	—	<b>XB7803</b>	
631	14"	26"-36"	<b>XB7800</b>	<b>XB10</b>	<b>XB04</b>	—	<b>XB7804</b>	
631	15 <sup>1</sup> / <sub>2</sub> "	36"-46"	<b>XB7800</b>	<b>XB10</b>	<b>XB05</b>	—	<b>XB7805</b>	
631	16 <sup>1</sup> / <sub>2</sub> "	46"-66"	<b>XB7800</b>	<b>XB10</b>	<b>XB06</b>	—	<b>XB7806</b>	
637	12"	26"-36"	<b>XB7800</b>	<b>XB10</b>	—	<b>XB07</b>	<b>XB7807</b>	
637	14 <sup>1</sup> / <sub>2</sub> "	36"-46"	<b>XB7800</b>	<b>XB10</b>	—	<b>XB08</b>	<b>XB7808</b>	
637	15 <sup>1</sup> / <sub>2</sub> "	46"-66"	<b>XB7800</b>	<b>XB10</b>	—	<b>XB09</b>	<b>XB7809</b>	



627 Posterior Panel



631 & 637 Posterior Panels

### C3™ - California Compressor Combo™

- Xyphoid height Anterior ABS panel; Rigid ABS Posterior Panel
- CoolFoam™ lines all thermoplastic components
- Patient-controlled compression tab to relieve pain and provide stability
- Compound closure system is simple to don and doff

**Indications:** Chronic low back pain; Muscle strain; Spondylolisthesis; Activity-specific back pain; Post-operative stabilization following Laminectomy, IDET and other surgical procedures

Size	Waist Circum.	Anterior Height	Posterior Height	Product No.	
				8" Belt	10" Belt
X-Small	25"-30"	8"	9"	<b>3329</b>	<b>3339</b>
Small	30"-35"	8 <sup>1</sup> / <sub>2</sub> "	9 <sup>3</sup> / <sub>4</sub> "	<b>3330</b>	<b>3340</b>
Medium	35"-40"	8 <sup>1</sup> / <sub>2</sub> "	10"	<b>3331</b>	<b>3341</b>
Large	40"-45"	8 <sup>1</sup> / <sub>2</sub> "	11"	<b>3332</b>	<b>3342</b>
X-Large	45"-50"	8 <sup>1</sup> / <sub>2</sub> "	11"	<b>3333</b>	<b>3343</b>
2X-Large	50"-55"	8 <sup>1</sup> / <sub>2</sub> "	11 <sup>3</sup> / <sub>4</sub> "	<b>3334</b>	<b>3344</b>
3X-Large	55"-60"	8 <sup>3</sup> / <sub>4</sub> "	12"	<b>3335</b>	<b>3345</b>
4X-Large	60"-65"	8 <sup>3</sup> / <sub>4</sub> "	12"	<b>3336</b>	<b>3346</b>



C3 Front view



C3 Back view

### California® Compression/Compressor Orthosis

- Low profile lumbar orthosis that provides maximum abdominal support with easy one-handed compression pull tab
- Breathable, comfortable mesh fabric minimizes heat build-up
- Lightweight for patients requiring support for everyday activities such as lifting, long periods of standing, work related motions, golf and gardening

**Indications:** Acute and chronic low back pain; Spondylolisthesis; Post-op low lumbar laminectomy



California Compression Orthosis

Size	Waist Circum.	Compression Orthosis		Compressor Orthosis	
		8" Belt	10" Belt	8" Belt	10" Belt
X-Small	25"-30"	3199	3209	3219	3229
Small	30"-35"	3200	3210	3220	3230
Medium	35"-40"	3201	3211	3221	3231
Large	40"-45"	3202	3212	3222	3232
X-Large	45"-50"	3203	3213	3223	3233
2X-Large	50"-55"	3204	3214	3224	3234
3X-Large	55"-60"	3205	3215	3225	3235
4X-Large	60"-65"	3206	3216	3226	3236

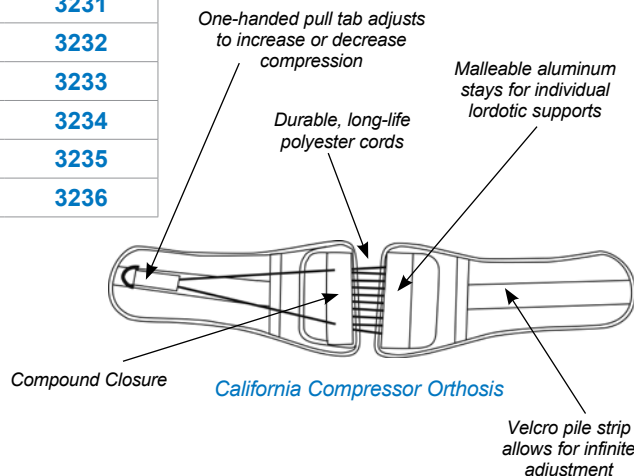

California Compressor Orthosis

### California Low Profile Orthosis

- Modular spinal system that provides stability without compromising respiration or interfering with activities of daily living
- Compound closure system is adjustable for both circumference and waist/hip development
- Low Profile LC is the lightweight and economical version of the Low Profile

**Indications:** Acute and chronic low back pain; Post-operative support; Activity-related low back pain; Patients that have problems tolerating xyphoid spinal systems

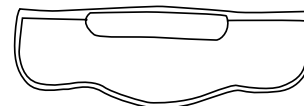
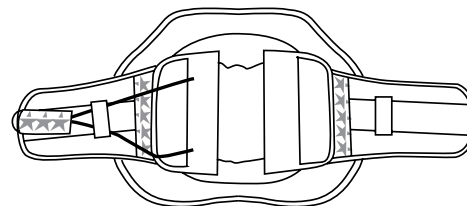

Low Profile

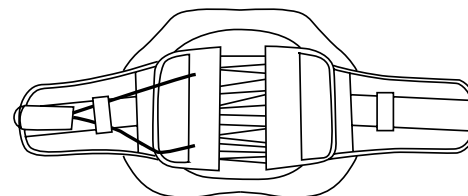

Low Profile LC

Size	Waist Circum.	Posterior Height		Product No.	
		Shell	Pad	Low Profile	Low Profile LC
X-Small	25"-30"	3289	3289.01	3289	3289.01
Small	30"-35"	3290	3290.01	3290	3290.01
Medium	35"-40"	3291	3291.01	3291	3291.01
Large	40"-45"	3292	3292.01	3292	3292.01
X-Large	45"-50"	3293	3293.01	3293	3293.01
2X-Large	50"-55"	3294	3294.01	3294	3294.01
3X-Large	55"-60"	3295	3295.01	3295	3295.01
4X-Large	60"-65"	3296	3296.01	3296	3296.01



### California Mid-Profile Orthosis

- Compound closure system provides patient-regulated compression to supplement abdominal musculature
- Coolfoam™ liner provides a comfortable patient interface
- Thermoplastic posterior component extends to T9 and provides total contact over the paraspinal muscles
- Anterior panel includes a pocket with an internal thermoplastic shell to provide abdominal support and control motion
- Thermoplastic components can be removed during the rehabilitation phase so the patient can strengthen abdominal and back muscles within a safe range of motion

**Indications:** Post-operative laproscopic disk replacement; Post-operative IDET procedures; Post-lumbar laminectomy; Post-operative spinal fusion; Chronic low back pain; Mechanical back pain with activities of daily living; When spinal control of extension and flexion is desired/required



Size	Waist Circum.	Anterior Panel		Posterior Panel	Product No.
		Height	Width	Height	
X-Small	25"-30"	8"	18"	12"	<b>3239</b>
Small	30"-35"	8 <sup>5</sup> / <sub>8</sub> "	14 <sup>1</sup> / <sub>4</sub> "	12"	<b>3240</b>
Medium	35"-40"	9"	10 <sup>3</sup> / <sub>8</sub> "	12"	<b>3241</b>
Large	40"-45"	9 <sup>5</sup> / <sub>8</sub> "	22"	13 <sup>1</sup> / <sub>2</sub> "	<b>3242</b>
X-Large	45"-50"	10"	24"	13 <sup>1</sup> / <sub>2</sub> "	<b>3243</b>
2X-Large	50"-55"	10"	26"	13 <sup>1</sup> / <sub>2</sub> "	<b>3244</b>
3X-Large	55"-60"	10"	27 <sup>3</sup> / <sub>4</sub> "	13 <sup>1</sup> / <sub>2</sub> "	<b>3245</b>

### California® CPO Orthosis - Chairback Mid-Profile Orthosis

- Posterior Chairback shell limits lower thoracic and lumbar spinal extension while providing a foundation for the compound closure system
- Xyphoid-height mid-profile anterior panel allows limited forward flexion - an acceptable motion particularly in some anterior spine procedures
- Compound closure is simple for patients to don and doff
- Orthosis can be transformed into an LS Orthopedic grade corset by removing rigid components

**Indications:** Stabilization following laminectomy; Anterior laproscopic fusion; Single or multiple level posterior spinal fusion; IDET procedures; Disc replacement; Spondylolisthesis; Spinal stenosis; Trauma; Chronic low back pain; Activity-specific back pain



Size	Waist Circum.	Anterior Height	Posterior Height	Product No.
X-Small	25"-30"	6 <sup>1</sup> / <sub>4</sub> "	13 <sup>3</sup> / <sub>4</sub> "	<b>2649</b>
Small	30"-35"	8"	14"	<b>2650</b>
Medium	35"-40"	9 <sup>1</sup> / <sub>4</sub> "	14 <sup>1</sup> / <sub>2</sub> "	<b>2651</b>
Large	40"-45"	9 <sup>1</sup> / <sub>4</sub> "	14 <sup>3</sup> / <sub>4</sub> "	<b>2652</b>
X-Large	45"-50"	10"	15"	<b>2653</b>
2X-Large	50"-55"	10"	15 <sup>1</sup> / <sub>2</sub> "	<b>2654</b>
3X-Large	55"-60"	10"	15"	<b>2655</b>



### California® Chairback Orthosis

- Designed for comfort and stability using a compound closure system
- Comfortable and CoolFoam™ liner
- Posterior opening eases pressure over incision sites, provides ventilation, and allows wound inspection without removal
- Internal plastic panels provide anterior rigidity and help block forward flexion while the chairback portion discourages lateral flexion and excessive extension

**Indications:** Post-operative laminectomy; fusion; IDET procedure; Chronic low back pain; Arthritic conditions; Spinal metastasis; Occupational protection

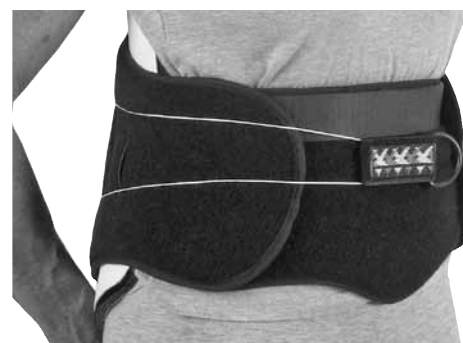

Anterior Panel Option



Size	Waist Circum.	Hip Circum.	Posterior Shell Height	8" Belt		10" Belt	
				Anterior Overlap	Anterior Panel	Anterior Overlap	Anterior Panel
<b>Men's</b>							
X-Small	28"-32"	33"-37"	11 <sup>1</sup> / <sub>4</sub> "	2039.02	2639.02	2039	2639
Small	30"-34"	35"-39"	11 <sup>1</sup> / <sub>2</sub> "	2040.02	2640.02	2040	2640
Medium	33"-37"	38"-42"	12"	2041.02	2641.02	2041	2641
Large	36"-42"	40"-46"	12 <sup>1</sup> / <sub>4</sub> "	2042.02	2642.02	2042	2642
X-Large	41"-47"	44"-50"	12 <sup>1</sup> / <sub>4</sub> "	2043.02	2643.02	2043	2643
2X-Large	46"-52"	48"-54"	12 <sup>1</sup> / <sub>2</sub> "	2044.02	2644.02	2044	2644
3X-Large	51"-57"	52"-58"	12 <sup>1</sup> / <sub>2</sub> "	2045.02	2645.02	2045	2645
<b>Women's</b>							
X-Small	22"-26"	30"-34"	10 <sup>1</sup> / <sub>2</sub> "	2029.02	2629.02	2029	2629
Small	24"-28"	32"-36"	10 <sup>3</sup> / <sub>4</sub> "	2030.02	2630.02	2030	2630
Medium	27"-31"	35"-39"	11 <sup>1</sup> / <sub>4</sub> "	2031.02	2631.02	2031	2631
Large	30"-36"	37"-43"	11 <sup>3</sup> / <sub>4</sub> "	2032.02	2632.02	2032	2632
X-Large	35"-41"	41"-47"	11 <sup>3</sup> / <sub>4</sub> "	2033.02	2633.02	2033	2633
2X-Large	40"-46"	45"-51"	11 <sup>3</sup> / <sub>4</sub> "	2034.02	2634.02	2034	2634
3X-Large	45"-51"	49"-55"	11 <sup>3</sup> / <sub>4</sub> "	2035.02	2635.02	2035	2635

### Kydex® Chairback Brace

- Lightweight, durable spinal orthosis helps maintain the spine in neutral alignment and permits ease of movement
- Low-profile brace offers excellent rigidity when worn with a snug corset front
- Fills the gap between soft lumbo-sacral supports and rigid leather and metal orthoses

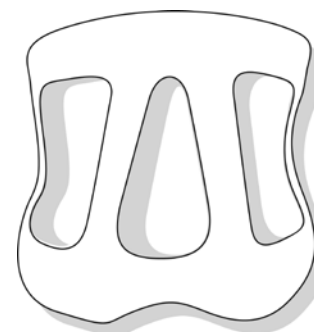

Size	Hip Circum.	Height*	Pelvic Band Length	Product No.		
				Without Corset	Pre-Laced Corset	Hook & Loop Corset
Small	29"-32"	11 <sup>1</sup> / <sub>2</sub> "	18 <sup>1</sup> / <sub>2</sub> "	2000	2005	2015
Medium	33"-36"	12 <sup>1</sup> / <sub>2</sub> "	20 <sup>1</sup> / <sub>2</sub> "	2001	2006	2016
Med/Large	37"-40"	13"	23 <sup>1</sup> / <sub>2</sub> "	2002	2007	2017
Large	41"-44"	13"	25"	2003	2008	2018

\*From coccyx notch to top of brace

### Ossur Americas - Miami Lumbar™

- Belt and its various support panels are sculpted to hug the contours of the back, providing comfort, stabilization and compliance
- Breathable Aerospacer fabric and ventilated support panels combine to keep Miami Lumbar cool and comfortable to wear for extended periods of time
- Trimmable belt combines with heat-moldable anterior and posterior panels to create a customizable, modular system
- Relieves pressure over the spinous processes while applying an even pressure to the paraspinal musculature to ensure comfortable and effective healing
- Four-to-one ratio drawstring and easy to use pulley system makes it simple to tighten, even for arthritic and/or geriatric patients

**Indications: Miami Lumbar Belt:** Spinal stenosis; Herniated discs; Degenerative spinal pathologies; **With added rigid panels:** Post-surgical stabilization; Stable, non-displaced spinal fractures (L2-L5); Spinal stenosis; Herniated discs; Degenerative spinal pathologies; Spondylolithesis; Spondylolysis



Posterior panel with lateral side supports



Belt with posterior and anterior panels

Size	Waist Circumference	Product No.	
<b>Belt Only</b>			
X-Small	26-30"	<b>LMB-001</b>	
Small	30-34"	<b>LMB-002</b>	
Medium	34-38"	<b>LMB-003</b>	
Large	38-42"	<b>LMB-004</b>	
X-Large	42-46"	<b>LMB-005</b>	
Universal X-Small-2X-Large	26- 50"	<b>LMB-006</b>	
3X-Large	50-54"	<b>LMB-007</b>	
4X-Large	54-58"	<b>LMB-008</b>	
5X-Large	58-62"	<b>LMB-009</b>	
Universal X-Small-6X-Large	26-66"	<b>LMB-010</b>	
<b>Anterior Panels</b>			
Description	Waist Circumference	Product No.	
Anterior Panel	up to 46"	<b>LMB-ST</b>	
Pendulous Panel	46"+	<b>LMB-PN</b>	
<b>Posterior Panels</b>			
<u>Product No.</u>			
Size	Waist Circumference	Without Lateral Support	With Lateral Support
Small	26-34"	<b>LMB-NS</b>	<b>LMB-LS</b>
Medium	34-38"	<b>LMB-NM</b>	<b>LMB-LM</b>
Large	38-50"	<b>LMB-NL</b>	<b>LMB-LL</b>
XLarge	50-66"	<b>LMB-NX</b>	<b>LMB-LX</b>

### RCAI - LSO

- Provides circumferential pressure to stabilize the spine
- Uses modular systems featuring thermoplastic Kydex® anterior and posterior panels, with polymer stays in lateral pockets
- Back panels have a surgical opening to relieve pressure at the incision site
- Breathable liners are made of a “wickable” material that keeps moisture away from the skin, promoting patient comfort and compliance

**Indications:** Lumbar fusion laminectomy; Compression fracture; Degenerative disc disease; Spondylolisthesis; Spinal stenosis; Osteoporosis



Size	Hip Circum.	Short Height		Average Height		Short	Average
		Back Panel	Front Panel	Back Panel	Front Panel		
Small	29"-35"	12"	9"	13"	10"	<a href="#">450LSO-SX-S</a>	<a href="#">450LSO-AV-S</a>
Medium	35"-40"	12"	9"	13"	10"	<a href="#">450LSO-SX-M</a>	<a href="#">450LSO-AV-M</a>
Large	40"-46"	12"	9"	13"	10"	<a href="#">450LSO-SX-L</a>	<a href="#">450LSO-AV-L</a>
X-Large	46"-52"	12"	9"	13"	10"	<a href="#">450LSO-SX-XL</a>	<a href="#">450LSO-AV-XL</a>
2X-Large	52"-58"	12"	9"	—	—	<a href="#">450LSO-SX-XXL</a>	—

### Truform - 962 - Chair Back (Knight) Spinal Orthosis

- Provides anterior, posterior and lateral control in the lumbar spine
- Fully padded rigid frame, tapered pelvic and thoracic bands, paraspinal and lateral uprights
- Corset-type abdominal front with truss buckle fastening, side lace adjustments
- 12" posterior uprights

Size	Hip Circumference	Product No.
Small	29"-32"	<a href="#">0962-S</a>
Medium	33"-36"	<a href="#">0962-M</a>
Medium/Large	37"-40"	<a href="#">0962-ML</a>
Large	41"-44"	<a href="#">0962-L</a>



### Trulife - CAMP XXI Knight Support

- Rigid LSO provides medial, lateral, posterior and anterior stability
- Height adjustable, padded aluminum posterior frame can be contoured
- Breathable material increases comfort; Easy donning and doffing

**Indications:** Contained herniations; Post operative spondylolisthesis; Post fusion

Size	Hip Circumference	Product No.	
		Standard	Pendulous
Small	31"-37"	<a href="#">0045202</a>	<a href="#">0045402</a>
Medium	35"-41"	<a href="#">0045203</a>	<a href="#">0045403</a>
Large	39"-45"	<a href="#">0045204</a>	<a href="#">0045404</a>
X-Large	43"-49"	<a href="#">0045205</a>	<a href="#">0045405</a>
2X-Large	47"-53"	<a href="#">0045206</a>	<a href="#">0045406</a>



CAMP XXI Knight Support

### Kydex® Chairback

- Provides medial, lateral, posterior and anterior stability
- Aluminum stays for easy contouring of paraspinal uprights
- 1/4" closed cell foam lining
- Available in short and standard heights

**Indications:** Post-op immobilization; Lumbar stabilization; Burst fractures; Compression fractures; Spinal stenosis; Spondylolysis

Size	Hip Measurement	Height	Pelvic Band Length	Product No.
Small	29"-32"	11 1/2"	18 1/2"	<b>JS-5000</b>
Medium	33"-36"	12 1/2"	20 1/2"	<b>JS-5001</b>
Med/Large	37"-40"	13"	23 1/2"	<b>JS-5003</b>
Short Md/Lg	37"-40"	13"	23 1/2"	<b>JS-5003-SHR</b>
Large	41"-44"	13"	25"	<b>JS-5004</b>
Short Large	41"-44"	13"	25"	<b>JS-5004-SHR</b>
X-Large	45"-48"	13 1/4"	25"	<b>JS-5004-XL</b>



Kydex Chairback  
Front View



Kydex Chairback  
Back View

### TLSO's

#### Aspen Medical - Evergreen TLSO

- 4-to-1 mechanical advantage through independent drawstrings which tighten the upper and lower sections
- Relieves acute and chronic pain in the Thoracic and lumbar spine
- Back panel and shoulder straps provide stability to create a dynamic environment for healing patients with complex spinal conditions
- Large pull tabs are easy to locate, grab and pull

**Indications:** Compression fractures; Burst fractures; Kyphosis

Size	Waist Circumference	Product No.
2X-Small	15"-21"	<b>36-5601</b>
X-Small	21"-27"	<b>36-5602</b>
Small	26"-32"	<b>36-5603</b>
Medium	31"-37"	<b>36-5604</b>
Large	36"-42"	<b>36-5605</b>
X-Large	41"-47"	<b>36-5606</b>
2X-Large	46"-57"	<b>36-5607</b>



#### Summit™ 456 TLSO

- Lightweight, sleek low profile design that returns kyphotic patients to a functional midrange, restore balance and reduce daily pain
- Vertically adjustable posterior support
- Powerful mechanical advantage with independent compression
- Ergonomic design accommodates all waist to hip ratios

**Indications:** Compression fractures; Burst fractures; Kyphosis; Fusions

Size	Waist Circum.	Men's Pants Size	Women's Pants Size	Product No.
Small	26"-34"	26"-32"	2-6	<b>992720</b>
Medium	33"-42"	32"-38"	8-16	<b>992730</b>
Large	41"-51"	38"-48"	18-26	<b>992740</b>
X-Large	50"-60"	48"-58"	26-36	<b>992750</b>



Summit 456  
Front View



Summit 456  
Back View

### Aspen TLSO

- Multiple orthotic options that provide a high degree of immobilization, comfort, and the ability to self-adjust patients
- VectorPoint™ Chest panel adjusts to the height and profile of each patient; this padded chest panel anchors the front and back of the brace to an anterior vector point in the upper thoracic region
- Optional torso control straps further limit flexion and rotation by linking the padded chest panel to a second location on the back of the brace

Size	Back Panel Height	Cut-Out Height	Circum.	Product No.	Replacement Pads
Short/Small	13"	8"	26"-39"	<b>991030</b>	<b>991035</b>
Short/Large	13"	8"	36"-49"	<b>991031</b>	<b>991036</b>
Tall/Small	16"	10"	32"-47"	<b>991070</b>	<b>991075</b>
Tall/Large	16"	10"	44"-59"	<b>991071</b>	<b>991076</b>



Full TLSO



TSLO Upgrade Kit	
Size	Product No.
X-Short	<b>991053</b>
Short	<b>991051</b>
Tall	<b>991050</b>
(kit includes chest panel, 2 shoulder straps, 2 torso control straps, rivet pack and clamp connection assembly pack)	

### SPK Option for the Contour TLSO

- The SPK is easy to apply, attaching to the current Rigid Anterior Panel (RAP) with thumbscrews and is specifically designed for supine fitting
- Comes with an anterior chest panel, torso control straps and is offered in (3) sizes
- Is the third option for the Contour TLSO, including the Shoulder Strap Option and Shoulder Straps with a Chest Panel Option
- The SPK option works independently of the other options

SPK (Sternal Pad Kit) Upgrade Kit			
Size	Sternal Notch to Navel	Product No.	
		White	Black
Small	up to 13"	<b>994405</b>	<b>994455</b>
Medium	11"-16"	<b>994410</b>	<b>994460</b>
Large	14+"	<b>994415</b>	<b>994465</b>

Contour TLSO with SPK Option*				
Size	Men's Pants Size	Women's Pants Size	Product No.	
			White	Black
Medium	28"-32"	5-9	<b>994301</b>	<b>994351</b>
Large	32"-36"	11-15	<b>994302</b>	<b>994352</b>
X-Large	26"-42"	17-21	<b>994303</b>	<b>994353</b>
2X-Large	42"-54"	23-33	<b>994304</b>	<b>994354</b>
*Includes (1) Quikdraw, (1) regular RAP, (1) 12" back panel and (1) medium SPK				



### Contour TLSO

- Offers superior restriction with low inventory and is the most comfortable, easy to don/doff brace on the market
- The modularity of the contour offers the provider with a T-bar configuration and a backpack option, while allowing step-down as functional mobility returns
- All items sold individually - picture shows complete brace



Picture shows complete Contour TLSO

Size	Waist Circumference	Product No.	
		White	Black
<b>(1) QuikDraw™</b>			
X-Small	21"-27"	<b>993080</b>	<b>993081</b>
Small	26"-32"	<b>993010</b>	<b>993011</b>
Medium	31"-37"	<b>993020</b>	<b>993021</b>
Large	36"-42"	<b>993030</b>	<b>993031</b>
X-Large	41"-47"	<b>993040</b>	<b>993041</b>
2X-Large	46"-57"	<b>993090</b>	<b>993091</b>
<b>(2) Rigid Anterior Panel (RAP)</b>			
Regular	—	<b>993100</b>	<b>993200</b>
Large	—	<b>993101</b>	<b>993201</b>
Size	Pad Set	Product No.	
		White	Black
<b>(3) Contour Back Panel</b>			
15"		<b>992125</b>	<b>992115</b>
12"		<b>992122</b>	<b>992112</b>
<b>(4) Shoulder Strap</b>			
Short		<b>994111</b>	<b>994101</b>
Tall		<b>994112</b>	<b>994102</b>
<b>(5) Chest Panel</b>			
Small	—	<b>994205</b>	<b>994255</b>
Medium	—	<b>994210</b>	<b>994260</b>
Large	—	<b>994215</b>	<b>994265</b>

Size	Extra Small	Small	Medium	Large	X-Large	2X-Large
Men's Pant Size	20-24"	24-28"	28-32"	32-36"	36-42"	42-54"
Women's Pant Size	Child to 0	1-3	5-9	11-15	17-21	23-33



### Becker Orthopedic - Model 101 Knight-Taylor TLSO

- Controls thoracolumbar flexion, thoracolumbar extension and lateral flexion
- Model 101 consists of two paraspinal bars and two lateral uprights attached superiorly to a thoracic band and inferiorly to a pelvic band
- The paraspinal bars extend superiorly and are attached to a interscapular band which serves as an attachment site for the auxiliary straps
- Abdominal support is secured to the lateral uprights with corset lacing

Size	A	B	C	H	H-I	Product No.
X-Small	28"-30"	26"-28"	28"-30"	10"	17"	<b>101-XS-AO</b>
Small	31"-33"	29"-32"	31"-33"	11"	18"	<b>101-S-AO</b>
Medium	34"-36"	33"-35"	34"-36"	12"	19"	<b>101-M-AO</b>
Large	37"-39"	36"-38"	37"-39"	13"	20"	<b>101-L-AO</b>
X-Large	40"-42"	39"-42"	40"-44"	14"	21"	<b>101-XL-AO</b>

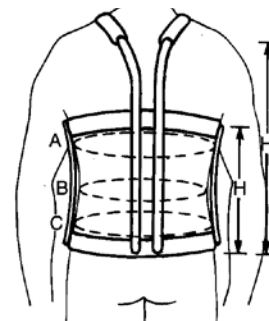

### Breg - BOA Duel TLSO Back Brace

- Provides full-circumferential rigid support from the T2/T3 scapular region to the sacrococcygeal junction
- Rigid anterior and posterior panels, a telescoping sternal aluminum Y-bar, and dual lacer compression pads
- Midline opening in posterior panel eases pressure over the incision site, allowing for wound inspection without removing the orthosis
- Latex free and heat moldable panels

**Indications:** Lumbar disc injury; Osteoporosis; Disc herniation and degeneration; Postoperative discectomy; IDET procedure; Spondylolithesis; Postoperative fusion; Spinal stenosis; Compression fractures; Scoliosis

Size	Waist Circumference	Product No.
Small	25" - 30"	<b>60002</b>
Medium	30" - 35"	<b>60003</b>
Large	35" - 42"	<b>60004</b>
X-Large	42" - 48"	<b>60005</b>
2X-Large	48" - 57"	<b>60006</b>

Circumference measurement taken at waist



BOA Duel TLSO

### Cybertech Medical - The Cybertech® Body Jacket

- Utilizes two Mechanical Advantage Pulley Systems to maximize rigid support
- Dual pulley system controls permit independent adjustment of upper and lower segments
- Single front fabric fastener makes it easy for patients to don/doff

Size	Waist Measurement	Product No.
Small	25"-30"	<b>BJKT-NW-1</b>
Medium	30"-35"	<b>BJKT-NW-2</b>
Large	35"-40"	<b>BJKT-NW-3</b>
X-Large	40"-45"	<b>BJKT-NW-4</b>
2X-Large	45"-50"	<b>BJKT-NW-5</b>
3X-Large	50"-55"	<b>BJKT-NW-6</b>



Cybertech Body Jacket

TLSO's

### DeRoyal - Ultralign® + Thoracic Lumbar Sacral Orthosis

- Constructed of hook receivable material with soft breathable liner that provides a cooler, lighter fit
- Dual dynamic closure system allows infinite adjustability and maximum compression
- Combines heat-moldable plastic inserts (anterior, posterior, lateral) for rigid support

**Indications:** Post-operative lumbar fusion; Laminectomy or disectomy; Lumbar compression fractures; Degenerative disc disease; Osteoporosis; Spondylolysis; Spondylolysis; Spinal stenosis; Facet syndrome

Size	Xyphoid	Waist	Trochanter	Product No.	
				15°	25°
<b>Non-Tapered</b>					
Small	31"-35"	31"-35"	31"-35"	<b>UPT1333-15</b>	<b>UPT1333-25</b>
Medium	34"-38"	32"-38"	34"-39"	<b>UPT1433-15</b>	<b>UPT1433-25</b>
Large	37"-41"	35"-41"	38"-42"	<b>UPT1533-15</b>	<b>UPT1533-25</b>
X-Large	38"-45"	38"-45"	38"-45"	<b>UPT1633-15</b>	<b>UPT1633-25</b>
2X-Large	45"-53"	45"-53"	45"-53"	<b>UPT1733-15</b>	<b>UPT1733-25</b>
<b>Tapered</b>					
Small	25"-31"	25"-31"	27"-33"	<b>UPT2333-15</b>	<b>UPT2333-25</b>
Medium	28"-35"	29"-36"	32"-38"	<b>UPT2433-15</b>	<b>UPT2433-25</b>
Large	32"-38"	32"-38"	35"-41"	<b>UPT2533-15</b>	<b>UPT2533-25</b>
X-Large	35"-42"	36"-42"	38"-46"	<b>UPT2633-15</b>	<b>UPT2633-25</b>
2X-Large	40"-46"	39"-47"	43"-49"	<b>UPT2733-15</b>	<b>UPT2733-25</b>
<b>Optional Accessories</b>					
Dorsal Lumbar Extension				<b>UDLE</b>	
Sternal Pad Kit				<b>USPK</b>	
3½" Extension Panels				<b>UEP2031</b>	
5½" Extension Panels				<b>UEP2051</b>	



SPK



DLE

**Circumferential Measurements:**

- Xyphoid:** 1" below tip of breast bone or xyphoid process
- Waist:** Around navel or waist
- Trochanter:** Around fullest area of trochanter or hips

### DonJoy - Duel TLSO

- Rigid anterior panel & posterior panels restrict forward flexion and trunk rotation
- Telescoping sternal Y-Bar can be adjusted to desired height or locked into position
- Quick release buckles allow for easy donning and doffing
- Mechanical Advantage Pulley System

**Indications:** Low back pain; Low back sprains/strains; Lumbar disc displacement; Osteoporosis; Disc herniation and degeneration; Post-operative laminectomy; Post-operative disectomy; IDET procedure; Spondylolisthesis; Post-operative fusion; Spinal stenosis; Compression fractures; Scoliosis

Size	Waist Circumference	Product No.
Small	25"-30"	<b>11-1561-2</b>
Medium	30"-35"	<b>11-1561-3</b>
Large	35"-42"	<b>11-1561-4</b>
X-Large	42"-48"	<b>11-1561-5</b>
2X-Large	48"-57"	<b>11-1561-6</b>





### Freeman Manufacturing - Combo™ Thoraco-Form™ TLSO Brace

- Knight-Taylor TLSO
- Lightweight plastic frame, but with aluminum uprights
- Elastic front closure with a 5" heavy elastic compression band
- Replace ?? with 16", 18", or 20" height (available in L, XL, 2XL only)

Size	Hip Measurement	Product No.
Small	32"-34"	<b>8122E-??S</b>
Medium	36"-38"	<b>8122E-??M</b>
Large	40"-42"	<b>8122E-??L</b>
X-Large	44"-46"	<b>8122E-??XL</b>
2X-Large	48"-50"	<b>8122E-??XXL</b>



TLSO's

### Hope Orthopedic - Extender™

- High-profile extensive force on a xyphoid-level body jacket design
- Kit comes with everything to install Extender on a spinal brace
- Options available: adjustable extension, shoulder straps, soft foam pressure plate pad covers; Universal sizing

Description	Product No.	
	Adjustable	Fixed
Pectoral w/Silicone Hinges	<b>EXT-PS-ADJ-BLK-NSC</b>	<b>EXT-PS-FXD-BLK-NSC</b>
Pectoral w/Rubber/Hook and Loop Hinges	<b>EXT-PV-ADJ-BLK-NSC</b>	<b>EXT-PV-FXD-BLK-NSC</b>
Sternal Hinged	<b>EXT-STH-ADJ-BLK-NSC</b>	<b>EXT-STH-FXD-BLK-NSC</b>
Sternal Fixed	<b>EXT-STF-ADJ-BLK-NSC</b>	<b>EXT-STF-FXD-BLK-NSC</b>
Sternal Fixed	<b>EXT-STF-ADJ-BLK-WSC</b>	<b>EXT-STF-FXD-BLK-WSC</b>
Over-the-Shoulder Strap Kit	<b>EXT-OTS-KIT-BLK</b>	



Extender

### OrthoLux TLSO

- Modular system with anterior, posterior and lateral pockets containing molded polymer panels
- Tri-laminate fabric is breathable, "moisture wicking", and hook and loop compatible
- D-ring closure straps are easy to apply for patient to don and doff

**Indications:** Chronic back pain; DDD; Herniated or bulging disc; Kyphosis; Post-laminectomy; Spinal stabilization; Spinal stenosis; Spondyloisthesis; Spondylolysis; Osteoporosis

Description	Product No.
OrthoLux TLSO	<b>ORT-TLS</b>
Over the Shoulder Strap Kit	<b>OP-TLS-EXT</b>

Sizing Chart			
Size	Hip	Waist	Rib
Small (SM)	29"-35"	28"-34"	28"-34"
Medium (MD)	32"-39"	30"-37"	30"-36"
Large (LG)	36"-42"	34"-42"	34"-40"
X-Large (XL)	39"-47"	38"-45"	38"-45"
2X-Large (2X)	45"-52"	43"-51"	43"-51"
3X-Large (3X)	51"-56"	47"-55"	47"-55"
4X-Large (4X)	57"-63"	53"-61"	53"-61"



OrthoLux TLSO side view OrthoLux TLSO back view

Front
<b>SP</b> (standard height); <b>MP</b> (mid-profile height) <b>LP</b> (low-profile height); <b>PS</b> (pendulous, standard) <b>PM</b> (pendulous, mid); <b>PL</b> (pendulous, low)
Lordis
0, 7, 15 or 25

Ordering Example	
Model . . . . .	<b>ORT-TLS</b>
Sex . . . . .	<b>U</b>
Size . . . . .	<b>LG</b>
Front . . . . .	<b>SP</b>
Lordosis . . . . .	<b>15</b>
	<b>ORT-TLS-U-LG-SP-15</b>

### Medi USA - Spinomed® III Model 859 Osteoporosis Brace

- Anti-migration straps and silicone beads keep brace in position
- Uses padded moisture wicking material at all contact points
- No restriction of shoulder and arm movements
- No restriction of thoracic and abdominal breathing

**Indications:** Osteoporotic bone collapse in the thoracic and lumbar spine; Hyper-kyphosis

Size	Back Length	Product No.
X-Small	14 <sup>1</sup> / <sub>2</sub> "-17 <sup>1</sup> / <sub>2</sub> "	<b>85921</b>
Small	17 <sup>1</sup> / <sub>4</sub> "-20"	<b>85922</b>
Medium	19 <sup>1</sup> / <sub>2</sub> "-22"	<b>85923</b>
Large	21 <sup>3</sup> / <sub>4</sub> "-24"	<b>85924</b>



### Spinomed III Model 860 Osteoporosis Brace

- Similar to Spinomed III Model 806 with the following additions
- Additional full width posterior panel and anterior panel
- Posterior and anterior panels contained in moisture wicking fabric

**Indications:** Osteoporotic bone collapse in the thoracic and lumbar spine; Hyper-kyphosis

Size	Back Length	Product No.
X-Small	14 <sup>1</sup> / <sub>2</sub> "-17 <sup>1</sup> / <sub>2</sub> "	<b>86021</b>
Small	17 <sup>1</sup> / <sub>4</sub> "-20"	<b>86022</b>
Medium	19 <sup>1</sup> / <sub>2</sub> "-22"	<b>86023</b>
Large	21 <sup>3</sup> / <sub>4</sub> "-24"	<b>86024</b>



### Optec - Primo™ Classic TLSO

- Provides maximum compression to unload intervertebral discs and restrict unwanted motion
- Spacer fabric has lower volumetric weight, less bulky than laminates
- Built-in reinforcement and spinal relief opening

**Indications:** Burst Fx; Chronic back pain; Compression fracture; Degenerative, herniated or bulging disc; Kyphosis; Laminectomy; Osteoporosis; Paraplegia; Post-operative; Spinal stabilization; Spinal stenosis; Spondylolysis; Spondylolisthesis

Size	Hip	Waist	Product No.
X-Small	31"-37"	26"-32"	<b>PCTLXS</b>
Small	35"-41"	30"-36"	<b>PCTLSM</b>
Medium	39"-45"	34"-40"	<b>PCTLMD</b>
Large	43"-49"	38"-44"	<b>PCTLLG</b>
X-Large	47"-53"	42"-48"	<b>PCTLXL</b>
2X-Large	51"-57"	46"-52"	<b>PCTL2X</b>
3X-Large	55"-61"	50"-56"	<b>PCTL3X</b>



Primo Classic TLSO  
Soft Front with a Rigid Back

### Lumbitec TLSO

- Anterior and posterior moldable polymer panels, rear and lateral anatomical stays and a unique traction closure system
- During progressive stages of rehabilitation, the detachable polymer panels can be removed to create a corset with flexible stays
- The remaining flexible stays can be adapted or removed to provide your patients with the desired support and a custom fit

**Indications:** Burst fracture; Post-op spinal stabilization; Post-op disc surgery; Degenerative; Herniated or bulging disc; Spondylolysis; Spondylolisthesis; Facet Syndrome; Spinal stenosis; Tumors; Inflammation

Size	Hip Circumference	Product No.
Small	31"-35"	<a href="#">FX213SM</a>
Medium	35"-39"	<a href="#">FX213MD</a>
Large	39"-43"	<a href="#">FX213LG</a>
X-Large	43"-47"	<a href="#">FX213XL</a>
2X-Large	47"-51"	<a href="#">FX2132X</a>
3X-Large	51"-55"	<a href="#">FX2133X</a>
4X-Large	55"-59"	<a href="#">FX2134X</a>



### Oasis TLSO

- Closure system with hook-and-loop secures itself directly to the front rigid panel
- The adjustable strap length and D-rings provide a custom fit and secure grip essential for easy donning and doffing
- The Oasis is a modular system where anterior and posterior pieces are interchangeable
- Anterior height: 9<sup>1</sup>/<sub>2</sub>"-11", Posterior height: 16"
- Low-Profile Anterior height: 6<sup>1</sup>/<sub>2</sub>", Posterior height: 11<sup>1</sup>/<sub>2</sub>"

**Indications:** Burst Fx; Chronic back pain; Compression fracture; Degenerative, herniated or bulging disc; Kyphosis; Laminectomy; Osteoporosis; Paraplegia; Post-operative; Spinal stabilization; Spinal stenosis; Spondylolysis; Spondylolisthesis

Size	Hip	Waist	Product No.
X-Small	31"-37"	26"-32"	<a href="#">OATLXS</a>
Small	35"-41"	30"-36"	<a href="#">OATLSM</a>
Medium	39"-45"	34"-40"	<a href="#">OATLMD</a>
Large	43"-49"	38"-44"	<a href="#">OATLLG</a>
X-Large	47"-53"	42"-48"	<a href="#">OATLXL</a>
2X-Large	51"-57"	46"-52"	<a href="#">OATLXXL</a>
3X-Large	55"-61"	50"-56"	<a href="#">OATLXXXL</a>



### Orthomerica - California® ECO™ - Extension Compression Orthosis

- California Compression abdominal component, made of cool, breathable mesh provides cinching mechanical advantage
- Detachable abdominal component can be used independently of remaining system to provide a functional lumbar spinal orthosis
- Padded shoulder straps loosen without completely unfastening in order to facilitate simple reapplication
- Contourable aluminum "spine" is lined with CoolFoam™ and extends from the thoracic area to the sacrococcygeal junction
- The height of the posterior aluminum spine on the standard model is 16<sup>1</sup>/<sub>2</sub>" and the tall model is 18<sup>1</sup>/<sub>2</sub>"
- The tall size is usually indicated for patients 5'9" and taller
- The anterior height is approximately 7"
- Available in Black

**Indications:** Thoracic compression fracture; Kyphosis; Early through late stages of osteoporosis; Strain in upper thoracic spine due to sustained positioning at keyboard or other repetitive tasks; Acute pain relieved by thoracic extension



Size	Waist Circumference	Product No.	
		Standard	Tall
X-Small	25"-30"	3253	3273
Small	30"-35"	3254	3274
Medium	35"-40"	3255	3275
Large	40"-45"	3256	3276
X-Large	45"-50"	3257	3277

### California® Lombar™ - Lightweight Osteoporosis Mobility Brace for Active Rehabilitation

- Streamlined, low-profile orthosis that promotes thoracic extension without interfering with normal activities
- "Aluminum spine" provides strength and stability while conforming intimately to the patient's body to provide stability and pain relief
- Apron front closes with hook and loop via dual pull tabs with finger pockets for easily controllable, adjustable compression
- Soft CoolFoam™ liner and patient-controlled thoracic extension straps

**Indications:** Thoracic pain/instability; Thoracic compression fractures; Early stages of Osteoporosis; Acute and chronic pain relieved by thoracic extension; Post-operative support; Kyphosis; Spinal stenosis



Size	Height	Product No.
Standard	up to 5'9"	3285
Tall	5'9"+	3286

### California® Soft Spinal System

- Strapping arrangement provides easy-to-adjust compression
- Pre-formed ABS (plastic) neutral or pendulous anterior insert panel, neutral (15°) or 0° posterior panels
- All components pre-drilled for retrofitting and interchangeability
- Hypoallergenic, breathable foam wicks away moisture from patient's skin for increased comfort

**Indications:** Spinal problems between L3 and S1; Effective for more superior spinal problems between T7 and L3 by adding an anterior, posterior or combined upper thoracic component



TLSO's

Size	Chest	Waist	Hip	Brace Height			Standard	Posterior Spinal Relief
				Standard Anterior	Low-Cut Anterior	Posterior		
<b>Women's</b>								
X-Small	26"-30"	22"-26"	30"-34"	9"	6 <sup>1</sup> / <sub>2</sub> "	15 <sup>1</sup> / <sub>2</sub> "	<b>3299</b>	<b>3350</b>
Small	28"-32"	24"-28"	32"-36"	9 <sup>1</sup> / <sub>2</sub> "	7"	16 <sup>1</sup> / <sub>2</sub> "	<b>3300</b>	<b>3351</b>
Medium	31"-35"	27"-31"	35"-39"	10"	7 <sup>1</sup> / <sub>2</sub> "	16 <sup>3</sup> / <sub>4</sub> "	<b>3301</b>	<b>3352</b>
Large	33"-39"	30"-36"	37"-43"	10 <sup>1</sup> / <sub>2</sub> "	8"	17 <sup>1</sup> / <sub>4</sub> "	<b>3302</b>	<b>3353</b>
X-Large	37"-43"	35"-41"	41"-47"	11"	8 <sup>1</sup> / <sub>2</sub> "	17 <sup>3</sup> / <sub>4</sub> "	<b>3303</b>	<b>3354</b>
2X-Large	41"-47"	40"-46"	45"-51"	12"	8 <sup>1</sup> / <sub>2</sub> "	18 <sup>1</sup> / <sub>4</sub> "	<b>3304</b>	<b>3355</b>
3X-Large	45"-51"	45"-51"	49"-55"	12 <sup>1</sup> / <sub>2</sub> "	8 <sup>1</sup> / <sub>2</sub> "	19 <sup>3</sup> / <sub>4</sub> "	<b>3305</b>	<b>3356</b>
<b>Men's</b>								
X-Small	32"-36"	28"-32"	33"-37"	10 <sup>1</sup> / <sub>2</sub> "	8"	16 <sup>1</sup> / <sub>2</sub> "	<b>3306</b>	<b>3360</b>
Small	34"-38"	30"-34"	35"-39"	11"	8 <sup>1</sup> / <sub>2</sub> "	16 <sup>1</sup> / <sub>2</sub> "	<b>3307</b>	<b>3361</b>
Medium	37"-41"	33"-37"	38"-42"	11"	9"	17 <sup>1</sup> / <sub>2</sub> "	<b>3308</b>	<b>3362</b>
Large	39"-45"	36"-42"	40"-46"	11"	9 <sup>1</sup> / <sub>2</sub> "	17 <sup>1</sup> / <sub>2</sub> "	<b>3309</b>	<b>3363</b>
X-Large	43"-49"	41"-47"	44"-50"	11"	10"	17 <sup>1</sup> / <sub>2</sub> "	<b>3310</b>	<b>3364</b>
2X-Large	47"-53"	46"-52"	48"-54"	11 <sup>1</sup> / <sub>2</sub> "	10"	18 <sup>1</sup> / <sub>4</sub> "	<b>3311</b>	<b>3365</b>
3X-Large	51"-57"	51"-57"	52"-58"	12"	10"	19 <sup>3</sup> / <sub>4</sub> "	<b>3312</b>	<b>3366</b>

Options			
Anterior	Back	Closure	Extension
Standard Shell (STD) = <b>A1</b>	15° Back (15BK) = <b>B1</b>	Standard Side Closure (SC) = <b>C1</b>	No Extension = <b>E1</b>
PA Shell (PA) = <b>A2</b>	0° Back (0 BK) = <b>B2</b>	Single Pull Closure (SP) = <b>C2</b>	ATE (ATE) = <b>E2</b>
Low Cut Shell (LC) = <b>A3</b>		Double Pull Closure (DP) = <b>C3</b>	PTE (PTE) = <b>E3</b>
Low Cut PA Shell (LC PA) = <b>A4</b>			ATE&PTE = <b>E4</b>

Optional Components (Universal)	Product No.
Std. California Compound Closure System (upgrade from CASS)	<b>3299.28</b>
California Posterior Thoracic Extension (PTE)	<b>3299.02</b>
Standard Anterior Thoracic Extension (ATE)	<b>2013</b>
Standard Anterior Thoracic Extension (ATE) Aluminum Sternum	<b>2013.05</b>
Extended Anterior Thoracic Extension (ATE)	<b>2014</b>
Lateral Control Panels (for increased lateral stability)	<b>3299.03</b>
Dorsal Pad/Strap Kit	<b>3299.04</b>
Posterior Air Bladder	<b>3299.05</b>
3" Pectoral Pad	<b>2013.03</b>

Ordering Example	
Model . . . . .	<b>3301</b>
Anterior . . . . .	<b>A2</b>
Back . . . . .	<b>B1</b>
Closure . . . . .	<b>C3</b>
Extension . . . . .	<b>E2</b>
<b>3301.A2B1C3E2</b>	

### Ossur Americas - Miami Lumbar® TLSO

- Designed for pain relief, the protection of injured ligaments or muscles and post-surgical immobilization
- TLSO attachment can be used for maximum immobilization, which stabilizes the spine up to T7
- As patient progresses through different levels of healing, you can step-down the TLSO to a standard LSO brace, or remove the ATE and add the optional axillary shoulder straps to the PTE

**Indications: Miami Lumbar Belt:** Spinal stenosis; Herniated discs and degenerative spinal pathologies; **With Added Rigid Panels:** Post-surgical stabilization; Stable, non-displaced spinal fractures; Spinal stenosis; Herniated discs; Degenerative spinal pathologies; Spondylolisthesis; Spondylolysis



Miami Lumbar TLSO  
(belt not included)

Description	Product No.
TLSO System with ATE & PTE	LMB-T01
PTE Only	LMB-T02

### RCAI - Model 460 TLSO and Model 1460 TLSO with Sternal Attachment

- Provide circumferential pressure to stabilize the spine
- Uses modular systems featuring thermoplastic Kydex® anterior and posterior panels, with polymer stays in lateral pockets
- Back panels have a surgical opening to relieve pressure at the incision site
- Breathable liners are made of a “wickable” material that keeps moisture away from the skin, promoting patient comfort and compliance

**Indications:** Lumbar fusion laminectomy; Compression fracture; Degenerative disc disease; Spondylolisthesis; Spinal stenosis; Osteoporosis



460 TLSO  
without Sternal Attachment



1460 TLSO  
with Sternal Attachment



Sternal Pad

Size	Hip Circum.	Panel Height		Product No.	
		Back	Front	460 TLSO	1460 TLSO*
<b>Short</b>					
Small	29"-35"	17"	9"	460TLS-SX-S	1460-TLS-SX-S
Medium	35"-40"	17"	9"	460TLS-SX-M	1460-TLS-SX-M
Large	40"-46"	17"	9"	460TLS-SX-L	1460-TLS-SX-L
X-Large	46"-52"	17"	9"	460TLS-SX-XL	1460-TLS-SX-XL
2X-Large	52"-58"	17"	9"	—	1460-TLS-SX-XXL
<b>Average</b>					
Small	29"-35"	19"	10"	460TLS-AV-S	1460-TLS-AV-S
Medium	35"-40"	19"	10"	460TLS-AV-M	1460-TLS-AV-M
Large	40"-46"	19"	10"	460TLS-AV-L	1460-TLS-AV-L
X-Large	46"-52"	19"	10"	460TLS-AV-XL	1460-TLS-AV-XL
2X-Large	52"-58"	19"	10"	—	1460-TLS-AV-XL
<b>Sternal Pads</b>					
Size	Width		Product. No		
Small/Medium	6 1/4"		460SA-S/M		
Large/X-Large	7 1/4"		460SA-L/XL		
*comes with sternal attachment					

**Truform - 957 - Knight-Taylor TSLO with 21" Uprights**

- Provides anterior/posterior/lateral control in the thoracolumbar spine
- Fully padded rigid frame
- Tapered pelvic and thoracic bands, paraspinal and lateral uprights
- Corset type abdominal front with truss buckle fastening, side lace adjustment
- Each size available in 17", 19" or 21" posterior uprights

Size	Hip Circumference	Product No.
Small	29"-32"	<b>0957/21-S</b>
Medium	33"-36"	<b>0957/21-M</b>
Medium/Large	37"-40"	<b>0957/21-ML</b>
Large	41"-44"	<b>0957/21-L</b>



**Trulife - CAMP XXI Taylor Support**

- Limits lumbar and lower thoracic spin motion
- Provides mild hyperextension of the lumbosacral joint
- Height adjustable posterior uprights and padded shoulder straps

**Indications:** Disorders affecting the spine and requiring immobilization of flexoextension, rotation, and lateral inflexion in the middle and lower dorsal region of the spine and the entire lumbar region of the spine; Contained herniations; Burst fracture; Post fusion

Size	Hip Circumference	Product No.	
		Standard	Pendulous
Small	31"-37"	<b>0045702</b>	<b>0045802</b>
Medium	35"-41"	<b>0045703</b>	<b>0045803</b>
Large	39"-45"	<b>0045704</b>	<b>0045804</b>
X-Large	43"-49"	<b>0045705</b>	<b>0045805</b>
2X-Large	47"-53"	<b>0045706</b>	<b>0045806</b>



## Becker Orthopedic - B.O.S.S. TLSO with Articulating Pelvic Section

- Adjustable lateral uprights with serrated discs for easy angular adjustments
- Articulating, spring loaded, pelvic section
- Flexible back pad for added patient comfort
- Swivel Sternal pad
- NOTE: The superior border of the sternal pad should be located  $\frac{1}{2}$ " below the sternal notch; the inferior border of the suprapubic pad should be  $\frac{1}{2}$ " superior to the symphysis pubis



Size	A	B	C	H	S-P	Product No.
X-Small	28"-30"	25"-28"	28"-31"	4 <sup>3</sup> / <sub>8</sub> "-7 <sup>1</sup> / <sub>4</sub> "	16"-17"	<b>Q-31A-XS</b>
Small	30"-33"	28"-31"	31"-34"	4 <sup>3</sup> / <sub>8</sub> "-7 <sup>1</sup> / <sub>4</sub> "	17"-18"	<b>Q-31A-S</b>
Medium	33"-36"	31"-34"	34"-37"	6"-8 <sup>1</sup> / <sub>4</sub> "	18"-20"	<b>Q-31A-M</b>
Large	36"-40"	34"-37"	37"-40"	6 <sup>5</sup> / <sub>8</sub> "-9 <sup>3</sup> / <sub>4</sub> "	19"-21"	<b>Q-31A-L</b>
X-Large	40"-44"	37"-40"	40"-44"	6 <sup>5</sup> / <sub>8</sub> "-9 <sup>3</sup> / <sub>4</sub> "	20"-22"	<b>Q-31A-XL</b>

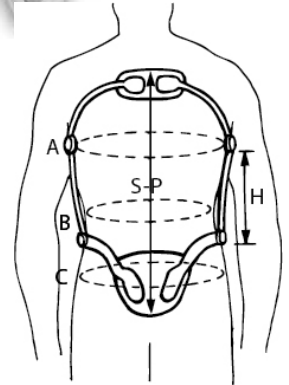

## Hyperextension TLSO with Swivel Sternal Pad and Dot Fastener or Worm Gear Closure

- Swivel sternal pad
- Lateral uprights are padded and adjustable in length

Size	Adjustable		Non-Adjustable Closure	
	Dot Fastener	Worm Gear	Dot Fastener	Worm Gear
X-Small	<b>L25A-XS</b>	<b>W25A-XS</b>	<b>L25-XS</b>	<b>W25-XS</b>
Small	<b>L25A-S</b>	<b>W25A-S</b>	<b>L25-S</b>	<b>W25-S</b>
Medium	<b>L25A-M</b>	<b>W25A-M</b>	<b>L25-M</b>	<b>W25-M</b>
Large	<b>L25A-L</b>	<b>W25A-L</b>	<b>L25-L</b>	<b>W25-L</b>
X-Large	<b>L25A-XL</b>	<b>W25A-XL</b>	<b>L25-XL</b>	<b>W25-XL</b>



## Hyperextension TLSO with Swivel Sternal Pad, Pelvic Bar and Dot Fastener or Worm Gear Closure

- Swivel sternal pad
- Provided with a pelvic bar which reduces pressure on the bladder
- Lateral uprights are padded and adjustable in length

Size	Adjustable		Non-Adjustable Closure	
	Dot Fastener	Worm Gear	Dot Fastener	Worm Gear
X-Small	<b>L27A-XS</b>	<b>W27A-XS</b>	<b>L27-XS</b>	<b>W27-XS</b>
Small	<b>L27A-S</b>	<b>W27A-S</b>	<b>L27-S</b>	<b>W27-S</b>
Medium	<b>L27A-M</b>	<b>W27A-M</b>	<b>L27-M</b>	<b>W27-M</b>
Large	<b>L27A-L</b>	<b>W27A-L</b>	<b>L27-L</b>	<b>W27-L</b>
X-Large	<b>L27A-XL</b>	<b>W27A-XL</b>	<b>L27-XL</b>	<b>W27-XL</b>





### Hyperextension TLSO with Swivel Sternal Pad and Quick Release Closure

- Consists of an anterior thoracic and pelvic assembly, each of which is attached to serrated discs on the superior and inferior margins of the lateral uprights
- Lateral uprights are padded and adjustable in length
- Posterior thoracolumbar pad is attached to the lateral uprights by Quick Release closure system

Size	A	B	C	H	S-P	Product No.
X-Small	28"-30"	25"-28"	28"-31"	4 <sup>3</sup> / <sub>8</sub> "-7 <sup>1</sup> / <sub>4</sub> "	16"-17"	<b>Q-25A-XS</b>
Small	30"-33"	28"-31"	31"-34"	4 <sup>3</sup> / <sub>8</sub> "-7 <sup>1</sup> / <sub>4</sub> "	17"-18"	<b>Q-25A-S</b>
Medium	33"-36"	31"-34"	34"-37"	6"-8 <sup>1</sup> / <sub>4</sub> "	18"-20"	<b>Q-25A-M</b>
Large	36"-40"	34"-37"	37"-40"	6 <sup>5</sup> / <sub>8</sub> "-9 <sup>3</sup> / <sub>4</sub> "	19"-21"	<b>Q-25A-L</b>
X-Large	40"-44"	37"-40"	40"-44"	6 <sup>5</sup> / <sub>8</sub> "-9 <sup>3</sup> / <sub>4</sub> "	20"-22"	<b>Q-25A-XL</b>



Hyperextension  
Bracing

### Dynamic Extension Orthosis

- Utilizes a three-point pressure system to dynamically reduce kyphotic posture and the pain often associated with compression fractures
- Dynamic extension is achieved by pulling on distal straps
- Adjustable lateral uprights have proximal serrations to ensure ease of adjustment and a precise fit
- The superior border of the sternal pad should be located 1/2" below the sternal notch. The inferior border of the suprapubic pad should be 1/2" superior to the symphysis pubis

Size	A	B	C	H	S-P	Product No.
X-Small	28"-30"	25"-28"	28"-31"	4 <sup>3</sup> / <sub>8</sub> "-7 <sup>1</sup> / <sub>4</sub> "	16"-17"	<b>Q-35A-XS</b>
Small	30"-33"	28"-31"	31"-34"	4 <sup>3</sup> / <sub>8</sub> "-7 <sup>1</sup> / <sub>4</sub> "	17"-18"	<b>Q-35A-S</b>
Medium	33"-36"	31"-34"	34"-37"	6"-8 <sup>1</sup> / <sub>4</sub> "	18"-20"	<b>Q-35A-M</b>
Large	36"-40"	34"-37"	37"-40"	6 <sup>5</sup> / <sub>8</sub> "-9 <sup>3</sup> / <sub>4</sub> "	19"-21"	<b>Q-35A-L</b>
X-Large	40"-44"	37"-40"	40"-44"	6 <sup>5</sup> / <sub>8</sub> "-9 <sup>3</sup> / <sub>4</sub> "	20"-22"	<b>Q-35A-XL</b>



### Bell-Horn - AquaFlex Hyperextension Brace

- Pivoting hinge means the self-adjusting spring loaded pelvic bar moves to help comfort the patient while sitting or standing
- Lightweight yet strong, the material adds to the comfort and strength of the brace
- Contoured aluminum frame comes with a cushioned posterior pad
- Thoracolumbar pad can be oriented either horizontally or vertically and a unique spring-controlled "floating" pelvic band continually adjusting as the patient changes from a standing to a sitting position, without compromising brace function

Size	Waist Circumference	Sternum to Pubis	Product No.
Small	23 <sup>1</sup> / <sub>2</sub> "-28"	12 <sup>1</sup> / <sub>2</sub> "	<b>10003</b>
Medium/Short	29 <sup>1</sup> / <sub>2</sub> "-35"	12 <sup>1</sup> / <sub>2</sub> "	<b>10004</b>
Medium	29 <sup>1</sup> / <sub>2</sub> "-35"	13 <sup>1</sup> / <sub>2</sub> "	<b>10005</b>
Medium/Long	35"-41"	15"	<b>10004ML</b>
Large/Short	35"-41"	13 <sup>1</sup> / <sub>2</sub> "	<b>10006</b>
Large	35"-41"	15"	<b>10007</b>
X-Large	41"-45"	16"	<b>10008</b>
X-Large/Short	41"-45"	15"	<b>10009</b>



## Spinallite

- Functional support with a light structure in aluminum alloy (x-ray transparent) that extends and immobilizes the spinal column in case of osteoporosis or vertebral collapse

Size	Length	Hip Circumference	Product No.
X-Small	12"-14"	23"-37"	<b>10090XS</b>
Small	14"-16 <sup>1</sup> / <sub>2</sub> "	23"-41"	<b>10090S</b>
Medium	16 <sup>1</sup> / <sub>2</sub> "-19"	32"-45"	<b>10090M</b>
Large	19-21"	39"-51"	<b>10090L</b>
X-Large	21-23"	39"-51"	<b>10090XL</b>



## Cybertech Medical - Hyper-X Plus TLSO with Hinged Pubic Band

- Designed to extend or hyperextend the thoracic spine, maintaining immobilization and reducing load on the anterior vertebral bodies from T-7 to L2
- Spring loaded hinged pelvic band eliminating migration
- Articulating sternal pad
- Variable anatomical contour adjustment for proximal sternal frame customization

Size	Hip Range	Height Range	Product No.
Short Small	31"-35"	15"-19"	<b>HYXP-SS-03</b>
Small	31"-35"	17"-19"	<b>HYXP-SR-04</b>
Short Medium	35"-40"	17"-21"	<b>HYXP-MS-01</b>
Medium	35"-40"	19"-21"	<b>HYXP-MR-02</b>
Short Large	40"-44"	19"-21"	<b>HYXP-LS-05</b>
Large	40"-44"	21"-23"	<b>HYXP-LR-06</b>



**Florida Brace - J-35 - Genuine Jewett™  
Hyperextension Orthosis**

- Lightweight corrosion resistant anodized aluminum frame for great comfort along and superior durability
- Replace ? with closure type
- With an Outrigger add an -O to the end of the product number

Size	Number of Holes in Side Pad	Height*	Circumference		Product No.
			Chest**	Waist	
<b>X-Small</b>					
X-Short	07	14"-14 1/2"	23"-29"	18"-24"	<b>J35XS07?</b>
Short	09	14 1/2"-15 1/2"	23"-29"	18"-24"	<b>J35XS09?</b>
Regular	11	15 1/2"-16 1/2"	23"-29"	18"-24"	<b>J35XS11?</b>
<b>Small</b>					
X-Short	07	16"-16 1/2"	28"-35"	25"-32"	<b>J35SM07?</b>
Short	09	16 1/2"-17 1/2"	28"-35"	25"-32"	<b>J35SM09?</b>
Regular	11	17 1/2"-18 1/2"	28"-35"	25"-32"	<b>J35SM11?</b>
Tall	13	18 1/2"-19 1/2"	28"-35"	25"-32"	<b>J35SM13?</b>
X-Tall	15	19 1/2"-20 1/2"	28"-35"	25"-32"	<b>J35SM15?</b>
<b>Medium</b>					
X-Short	07	17 1/2"-18"	32"-42"	30"-40"	<b>J35MD07?</b>
Short	09	18"-19"	32"-42"	30"-40"	<b>J35MD09?</b>
Regular	11	19"-20"	32"-42"	30"-40"	<b>J35MD11?</b>
Tall	13	20"-21"	32"-42"	30"-40"	<b>J35MD13?</b>
X-Tall	15	21"-22"	32"-42"	30"-40"	<b>J35MD15?</b>
<b>Large</b>					
X-Short	07	19 1/2"-20"	36"-46"	34"-44"	<b>J35LG07?</b>
Short	09	20"-21"	36"-46"	34"-44"	<b>J35LG09?</b>
Regular	11	21"-22"	36"-46"	34"-44"	<b>J35LG11?</b>
Tall	13	22"-23"	36"-46"	34"-44"	<b>J35LG13?</b>
X-Tall	15	23"-24"	36"-46"	34"-44"	<b>J35LG15?</b>
<b>X-Large</b>					
X-Short	07	19 1/2"-20"	40"-52"	38"-50"	<b>J35XL07?</b>
Short	09	20"-21"	40"-52"	38"-50"	<b>J35XL09?</b>
Regular	11	21"-22"	40"-52"	38"-50"	<b>J35XL11?</b>
Tall	13	22"-23"	40"-52"	38"-50"	<b>J35XL13?</b>
X-Tall	15	24"-25"	40"-52"	38"-50"	<b>J35XL15?</b>
<b>J-35S Standard "Shorty" Brace Numbers</b>					
Closure	Caliper Length	Chest	Waist	Product No.	
Ratchet Size 1	10 1/2"	27"-33"	20"-30"	<b>J35SY1?</b>	
Ratchet Size 2	12 1/4"	33"-39"	30"-38"	<b>J35SY2?</b>	
Ratchet Size 3	13 1/2"	39"-45"	38"-45"	<b>J35SY3?</b>	
* Height measured from 2" below Sternal Notch to Symphysis Pubis					
** Chest measured at Axilla level					



Outrigger

Closure Type	
<b>SHL</b>	= Single Lumbar Strap Hook-and-Loop
<b>DHL</b>	= Double Lumbar Strap Hook-and-Loop
<b>MWG</b>	= Metal Worm Gear Closure
<b>PWG</b>	= Plastic Worm Gear Closure
<b>RCT</b>	= Ratchet Closure

Hyperextension  
Bracing

## J-45 - Jewett™ Contraflexion Orthosis

- Same benefits as the original Genuine Jewett J35 Hyperextension Orthosis
- Modified lower bars and a straight pubic pad for additional patient comfort
- Replace ? with closure type



Size	Number of Holes in Side Pad	Circumference			Product No.
		Height*	Chest**	Waist	
<b>X-Small</b>					
X-Short	07	11 <sup>1</sup> / <sub>2</sub> "-12"	23"-29"	18"-24"	<b>J45XS07?</b>
Short	09	12 <sup>1</sup> / <sub>2</sub> "-13 <sup>1</sup> / <sub>2</sub> "	23"-29"	18"-24"	<b>J45XS09?</b>
Regular	11	13 <sup>1</sup> / <sub>2</sub> "-14 <sup>1</sup> / <sub>2</sub> "	23"-29"	18"-24"	<b>J45XS11?</b>
Tall	13	14 <sup>1</sup> / <sub>2</sub> "-15 <sup>1</sup> / <sub>2</sub> "	23"-29"	18"-24"	<b>J45XS13?</b>
X-Tall	15	15 <sup>1</sup> / <sub>2</sub> "-16 <sup>1</sup> / <sub>2</sub> "	23"-29"	18"-24"	<b>J45XS15?</b>
<b>Small</b>					
X-Short	07	14 <sup>1</sup> / <sub>2</sub> "-15"	28"-35"	25"-32"	<b>J45SM07?</b>
Short	09	15 <sup>1</sup> / <sub>2</sub> "-16 <sup>1</sup> / <sub>2</sub> "	28"-35"	25"-32"	<b>J45SM09?</b>
Regular	11	16 <sup>1</sup> / <sub>2</sub> "-17 <sup>1</sup> / <sub>2</sub> "	28"-35"	25"-32"	<b>J45SM11?</b>
Tall	13	17 <sup>1</sup> / <sub>2</sub> "-18 <sup>1</sup> / <sub>2</sub> "	28"-35"	25"-32"	<b>J45SM13?</b>
X-Tall	15	18 <sup>1</sup> / <sub>2</sub> "-19 <sup>1</sup> / <sub>2</sub> "	28"-35"	25"-32"	<b>J45SM15?</b>
<b>Medium</b>					
X-Short	07	15 <sup>1</sup> / <sub>2</sub> "-16"	32"-42"	30"-40"	<b>J45MD07?</b>
Short	09	16 <sup>1</sup> / <sub>2</sub> "-17 <sup>1</sup> / <sub>2</sub> "	32"-42"	30"-40"	<b>J45MD09?</b>
Regular	11	17 <sup>1</sup> / <sub>2</sub> "-18 <sup>1</sup> / <sub>2</sub> "	32"-42"	30"-40"	<b>J45MD11?</b>
Tall	13	18 <sup>1</sup> / <sub>2</sub> "-19 <sup>1</sup> / <sub>2</sub> "	32"-42"	30"-40"	<b>J45MD13?</b>
X-Tall	15	19 <sup>1</sup> / <sub>2</sub> "-20 <sup>1</sup> / <sub>2</sub> "	32"-42"	30"-40"	<b>J45MD15?</b>
<b>Large</b>					
X-Short	07	16 <sup>1</sup> / <sub>2</sub> "-17"	36"-46"	34"-44"	<b>J45LG07?</b>
Short	09	17 <sup>1</sup> / <sub>2</sub> "-18 <sup>1</sup> / <sub>2</sub> "	36"-46"	34"-44"	<b>J45LG09?</b>
Regular	11	18 <sup>1</sup> / <sub>2</sub> "-19 <sup>1</sup> / <sub>2</sub> "	36"-46"	34"-44"	<b>J45LG11?</b>
Tall	13	19 <sup>1</sup> / <sub>2</sub> "-20 <sup>1</sup> / <sub>2</sub> "	36"-46"	34"-44"	<b>J45LG13?</b>
X-Tall	15	20 <sup>1</sup> / <sub>2</sub> "-21 <sup>1</sup> / <sub>2</sub> "	36"-46"	34"-44"	<b>J45LG15?</b>
<b>X-Large</b>					
X-Short	07	16 <sup>1</sup> / <sub>2</sub> "-17"	40"-52"	38"-50"	<b>J45XL07?</b>
Short	09	17 <sup>1</sup> / <sub>2</sub> "-18 <sup>1</sup> / <sub>2</sub> "	40"-52"	38"-50"	<b>J45XL09?</b>
Regular	11	18 <sup>1</sup> / <sub>2</sub> "-19 <sup>1</sup> / <sub>2</sub> "	40"-52"	38"-50"	<b>J45XL11?</b>
Tall	13	19 <sup>1</sup> / <sub>2</sub> "-20 <sup>1</sup> / <sub>2</sub> "	40"-52"	38"-50"	<b>J45XL13?</b>
X-Tall	15	20 <sup>1</sup> / <sub>2</sub> "-21 <sup>1</sup> / <sub>2</sub> "	40"-52"	38"-50"	<b>J45XL15?</b>
* Height measured from 2" below Sternal Notch to 2" above Symphysis Pubis					
** Chest measured at Axilla level					

### Closure Type

- SHL** = Single Lumbar Strap Hook-and-Loop
- DHL** = Double Lumbar Strap Hook-and-Loop
- MWG** = Metal Worm Gear Closure
- PWG** = Plastic Worm Gear Closure
- RCT** = Ratchet Closure

**Hope Orthopedic - ACE™ Brace (Pectoral Hook and Loop Pads)**

- Pectoral pads on sponge rubber disc with hook and loop fastener
- Hinged pubic assembly
- One size fits all back strap with pad
- Provides sternal pressure relief with no throat impingement

**Indications:** Flexible thoracic kyphosis; Stable compression fractures (T7-L2); Osteoporosis

Product No. **ACE-PV**



**ACE™ Brace (Sternal Pad)**

- Hinged sternal assembly
- Hinged pubic assembly
- One size fits all back strap with pad
- Most economical brace

**Indications:** Flexible thoracic kyphosis; Stable compression fractures (T7-L2); Osteoporosis

Product No. **ACE-ST**



**ACE™ Brace (300 Hyperextension)**

- Hinged sternal pad and pubic assembly
- Soft Volara foam padding
- Aluminum plates for rapid, precise fit
- One size fits all back strap

**Indications:** Flexible thoracic kyphosis; Stable compression fractures (T7-L2); Osteoporosis

Product No. **ACE-300**



**ACE™ Brace (Pectoral Silicone Pads)**

- Pectoral pads with adjustable silicone swivels
- Hinged pubic assembly
- Universal back strap and pad; front closure
- One size fits all back strap

**Indications:** Geriatric osteoporotic patient with prominent bony sternum, where orthotist desires pectoral pads to remain exactly as fitted

Product No. **ACE-PS**



Hyperextension  
Bracing

## Orthomerica - California® C.E.O.™ (Cruciform Extension Orthosis)

- Designed to extend the thoracic spine, prevent forward flexion, and limit rotation
- Compound closure system of this hyperextension orthosis provides excellent low back support, additional comfort and adjustable relief
- Two anterior thoracic extension (ATE) options - hinged swivel sternal pad or standard sternal relief design

**Indications:** Stable compression fractures between T-7 and L-2; Patients with flexible thoracic kyphosis; Need for thoracic extension to correct flexed posture; Thoracic instability and fractures accompanied by low back pain; Need for extension or hyperextension to promote spinal alignment and reduce pain

Size for Standard CEO	Vertical Bar Adjustment Range	Waist Size	Product No.
X-Small	12 <sup>1</sup> / <sub>2</sub> "-19 <sup>1</sup> / <sub>2</sub> "	25"-30"	<b>3380</b>
Small/Medium	12 <sup>1</sup> / <sub>2</sub> "-19 <sup>1</sup> / <sub>2</sub> "	30"-40"	<b>3381</b>
Large/X-Large	12 <sup>1</sup> / <sub>2</sub> "-19 <sup>1</sup> / <sub>2</sub> "	40"-50"	<b>3382</b>
2X-Large	12 <sup>1</sup> / <sub>2</sub> "-19 <sup>1</sup> / <sub>2</sub> "	50"-55"	<b>3383</b>

## RCAI - Hyperextension Orthosis

- Extends the throacic spine, preventing forward flexion and limits rotation
- Single screw height adjustment and heat moldable Kydex® thoracic and pubic areas, offering easy adjustment and patient customization
- Anterior thoracic and pubic areas are covered in anti-microbial foam liners that "wick" moisture away from the skin, keeping the patient dry and comfortable
- Flexible ethylene posterior panel with foam liner is supplied for increased stabilization and pain reduction

**Indications:** Stable thoracic and lumbar vertical compression fractures; Reduction of Kyphosis in patients with osteoporosis; To correct flexed posture accompanied by pain

Size	Measurements	Product No.
Short	14"-19"	<b>455-HEO-Sx</b>
Average	17"-22"	<b>455-HEO-Av</b>

Measure from pubic symphysis to sternal notch; Fits up to size 52" waist

## Truform - 950 - Hyperextension Orthosis

- Provides anterior control in the thoracolumbar spine; indicated for compression fractures and post-fusion
- Sternal pad on swivel base, with fixed supra-pubic and lateral pads
- Thoracolumbar pad with polyethylene flanges
- Adjustable posterior straps which incorporate positive screw-lock fastening mechanism

**Indications:** Compression fractures; Post-fusion

Size	Length	Chest	Hip	Product No.
Small	17"-20"	34"-38"	32"-36"	<b>0950-S</b>
Medium	18"-21"	38"-44"	36"-42"	<b>0950-M</b>
Large	20"-23"	44"-50"	42"-48"	<b>0950-L</b>



California C.E.O.



Hyperextension Orthosis



950 - Hyperextension Orthosis



950 - Rear View

**Trulife - C34 Hyperextension Thoracolumbar Orthosis with Pubic Pad**

- Anatomically designed pubic pad and pelvic bar avoids pressure on groin and prevents migration
- Sternal pad swivels to eliminate pressure
- Latch-lock clamp closure allows easy donning and doffing
- Adjustable height and width

**Indications:** Vertebral compression fractures; Osteoporosis; Dislocation; Vertebral arthritis; Post-surgical

Size	Hip Measurement	Front Height	Overall Product No.
Small	30"-32"	17"	<b>C003402</b>
Medium	34"-36"	18"	<b>C003403</b>
Large	38"-40"	19"	<b>C003404</b>
X-Large	42"-44"	21"	<b>C003405</b>



Hyperextension  
Bracing

**C35 Hyperextension Thoracolumbar Orthosis with Pelvic Band**

- Pelvic band anchors on ilium, avoiding pressure on bladder
- Sternal pad swivels to eliminate pressure
- Latch-lock clamp closure allows easy donning and doffing
- Adjustable height and width

**Indications:** Vertebral compression fractures; Osteoporosis; Dislocation; Vertebral arthritis; Post-surgical

Size	Hip Measurement	Overall Front Height	Pelvic Band Length	Without Corset
Small	30"-32"	17"	18"	<b>C003502</b>
Medium	34"-36"	18"	20"	<b>C003503</b>
Large	38"-40"	19"	22"	<b>C003504</b>
X-Large	42"-44"	21"	24"	<b>C003505</b>



**C37 Hyperextension Orthosis with Adjustable Angle Pelvic Band**

- Limits anterior, posterior and lateral movements
- Continuous adjustment of sternal, lateral and pelvic padded plates
- Posterior pad may be used horizontally or vertically
- Easy to donn and doff

**Indications:** Vertebral compression fractures; Osteoporosis; Dislocation; Vertebral arthritis; Post-surgical

Size	Hip Measurement	Front Height	Pelvic Band Length	Product No.
Small	30"-37"	17"-20"	17"-19"	<b>C37B02</b>
Large	31"-45"	19"-23"	21"-23"	<b>C37B04</b>



## C39 & CS39 Hyperextension Orthosis with Articulating Pelvic Band

- Articulating pelvic band and swivel sternal pad
- Posterior pad may be used horizontally or vertically
- Easy to donn and doff
- Available in regular or short version

**Indications:** Vetebtral compression fractures; Osteoporosis; Dislocation; Vertebral arthritis; Post-surgical

Size	Full Hip	Height	Product No.
Small	31"-35"	17"-19"	<b>C39B02</b>
Medium	35"-40"	19"-21"	<b>C39B03</b>
Large	40"-44"	21"-23"	<b>C39B04</b>
Small	31"-35"	15"-17"	<b>CS39B02</b>
Medium	35"-40"	17"-19"	<b>CS39B03</b>
Large	40"-44"	19"-21"	<b>CS39B04</b>
X-Large	44"-47"	21"-23.5"	<b>CS39B04</b>



## C.A.S.H Orthosis

- Pre-fabricated hyperextension orthosis
- Fully adjustable height and width with wide straps
- Cruciform does not make patient contact when worn

**Indications:** Stable compression fractures of T7-L2; Osteoporosis; Kyphosis; Osteoarthritis

Back Pad Size	30" Belt	36" Belt	42" Belt	48" Belt
<b>Fixed Sternal Pad and Fixed Pubic Pad (Original C.A.S.H. Orthosis)</b>				
Standard	<b>RSC100-ST-1</b>	<b>RSC100-ST-2</b>	<b>RSC100-ST-3</b>	<b>RSC100-ST-4</b>
Large	<b>RSC100-LG-1</b>	<b>RSC100-LG-2</b>	<b>RSC100-LG-3</b>	<b>RSC100-LG-4</b>
Large Vertical	<b>RSC100-LV-1</b>	<b>RSC100-LV-2</b>	<b>RSC100-LV-3</b>	<b>RSC100-LV-4</b>
<b>Hinged Sternal and Pubic Pad</b>				
Standard	<b>RSC300-ST-1</b>	<b>RSC300-ST-2</b>	<b>RSC300-ST-3</b>	<b>RSC300-ST-4</b>
Large	<b>RSC300-LG-1</b>	<b>RSC300-LG-2</b>	<b>RSC300-LG-3</b>	<b>RSC300-LG-4</b>
Large Vertical	<b>RSC300-LV-1</b>	<b>RSC300-LV-2</b>	<b>RSC300-LV-3</b>	<b>RSC300-LV-4</b>
<b>Hinged Sternal Pad and Fixed Pubic Pad</b>				
Standard	<b>RSC400-ST-1</b>	<b>RSC400-ST-2</b>	<b>RSC400-ST-3</b>	<b>RSC400-ST-4</b>
<b>Hinged Pectoral Pad and Hinged Pubic Pad</b>				
Standard	<b>RSC300-P-ST-1</b>	<b>RSC300-P-ST-2</b>	<b>RSC300-P-ST-3</b>	<b>RSC300-P-ST-4</b>
Large	<b>RSC300-P-LG-1</b>	<b>RSC300-P-LG-2</b>	<b>RSC300-P-LG-3</b>	<b>RSC300-P-LG-4</b>
Large Vertical	<b>RSC300-P-LV-1</b>	<b>RSC300-P-LV-2</b>	<b>RSC300-P-LV-3</b>	<b>RSC300-P-LV-4</b>
<b>Accessories</b>				
Upper Hinged pad with Foam Assembly				<b>RSC102-12</b>
Long Vertical Bar				<b>RSC105</b>
Long Posterior Strap, 48 <sup>3</sup> / <sub>10</sub> "				<b>RSC115</b>
Standard Posterior Strap, 36"				<b>RSC120</b>
Kodel Cover				<b>RSC125</b>
Articulating Pectoral Extension				<b>RSC130-P</b>
Front Closure Kit with 42" Strap				<b>RSC135-F</b>
Front Closure Kit with 48.3" Strap				<b>RSC135-FL</b>



RSC100



RSC300

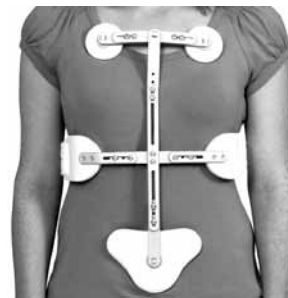

RSC300-P



**C.A.S.H. II Orthosis**

- Discreet, low profile design
- Hand-moldable, aluminum frame, sternal components and pubic components
- Articulating sternal and pubic pad
- Quick release system for easy application and removal

**Indications:** Stable compression fractures of T7-L2; Osteoporosis, Kyphosis; Osteoarthritis

Product No.

CASHII

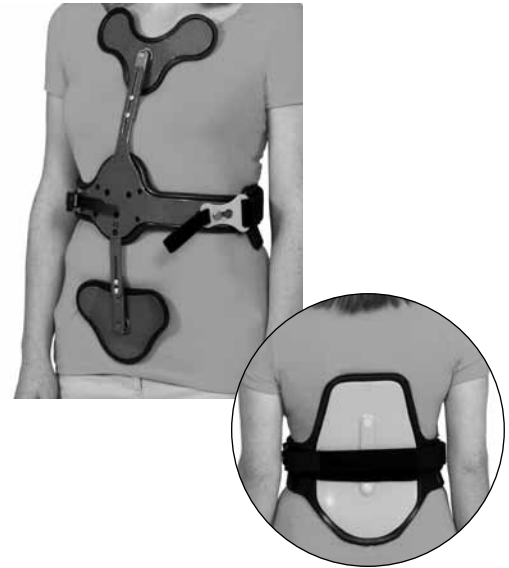

Maternity  
Supports

**SUPPORTS****ProCare (DJO) - Maternity Belt**

- 8" plush elastic belt helps relieve discomfort of lower abdomen and back during all stages of pregnancy
- Abdominal strap supports stomach while elastic back provides compression and support for lumbar area
- Optional 8" ComfortFORM moldable back insert #79-89120 provides additional support

Size	Measurement*	Product No.
Small	32"-42"	<b>79-89293</b>
Medium	42"-52"	<b>79-89295</b>
Large	52"-62"	<b>79-89297</b>
X-Large	62"-72"	<b>79-89298</b>

\*Hip measurement during pregnancy

**Scott Specialties - Mother-To-Be Maternity Support**

- Relieves muscles and ligaments strain by transferring the weight of the abdomen to the spine
- Lifts and supports the abdomen, reducing pelvic pressure
- Improves circulation in the legs

Size	Pre-Pregnancy Dress Size	Product No.
Small	3-8	<b>0050-SM</b>
Medium	9-14	<b>0050-MD</b>
Large	15-18	<b>0050-LG</b>
X-Large	19-21	<b>0050-XL</b>
2X-Large	22-26	<b>0050-2XL</b>
3X-Large	27-30	<b>0050-3XL</b>



**Trulife - Embrace Ultimate Support Maternity Belt**

- Maximum abdominal and lumbar support
- Evenly transfers the weight of the abdomen to the spine
- Contours to expanding abdomen
- Low temperature, heat moldable, rigid back support back panel available

**Indications:** Prenatal use; Stomach drop

Size	Hip Circumference	Product No.
Small	34"-40"	<b>0721002</b>
Medium	38"-44"	<b>0721003</b>
Large	42"-48"	<b>0721004</b>
X-Large	46"-52"	<b>0721005</b>



**Embrace Moderate Support Maternity Belt**

- Moderate abdominal and lumbar support
- Evenly transfers the weight of the abdomen to the spine

**Indications:** Back pain associated with pregnancy

Size	Hip Circumference	Product No.
Small	34"-40"	<b>0720502</b>
Medium	38"-44"	<b>0720503</b>
Large	42"-48"	<b>0720504</b>
X-Large	46"-52"	<b>0720505</b>
2X-Large	50"-56"	<b>0720506</b>



**Moldable Back Panel for Maternity Belts**

- For use with Embrace Ultimate and Moderate support belts

**Product No.**

**PT740**

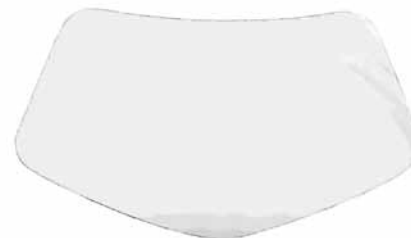

### Sacral and Lumbosacral Supports

- Ideal for back strains/sprains
- Support for lumbosacral region
- Posterior steel stays (some options may have posterior panel)
- Hook and eyelet closure

Bauerfeind

#### LumboLoc Back Support

- Lightweight, breathable, knitted support incorporates 4 oblong, metal stays
- Graduated compression at edges prevent rolling, hook-and-pile fastening and hand straps for easy applications
- Measures about 6<sup>1</sup>/<sub>2</sub>" wide in the front and 11" wide in the back

Size	Circumference below the waist	Product No.
1	27 <sup>1</sup> / <sub>2</sub> -31 <sup>1</sup> / <sub>2</sub> "	12184003080001
2	31 <sup>1</sup> / <sub>2</sub> -35 <sup>1</sup> / <sub>2</sub> "	12184003080002
3	35 <sup>1</sup> / <sub>2</sub> -39 <sup>1</sup> / <sub>4</sub> "	12184003080003
4	39 <sup>1</sup> / <sub>4</sub> -43 <sup>1</sup> / <sub>4</sub> "	12184003080004
5	43 <sup>1</sup> / <sub>4</sub> -47 <sup>1</sup> / <sub>4</sub> "	12184003080005
6	47 <sup>1</sup> / <sub>4</sub> -51 <sup>1</sup> / <sub>4</sub> "	12184003080006



Bell-Horn

#### Deluxe Sacro-Cinch

- One-way stretch elastic with hook-and-pile closure and two removable pre-bent stays
- Separate adjustable cinch-pull strap secured to wide elastic back sling
- Front height: 8<sup>1</sup>/<sub>2</sub>"; Back height: 10"

Size	Waist Measurement	Product No.	
		Men's	Women's
Small	30"-32"	89450 S	89430 S
Medium	34"-36"	89450 M	89430 M
Large	38"-40"	89450 L	89430 L
X-Large	42"-44"	89450 XL	89430 XL
2X-Large	46"-48"	89450 XXL	89430 XXL
3X-Large	50"-52"	89450 XXXL	89430 XXXL



#### Men's Sacro-Cinch with Pocket

- One-way stretch elastic with hook-and-pile closure and two removable plastic flexible stays
- Separate adjustable cinch-pull strap secured to wide elastic back sling; comes with a pocket for heat moldable insert
- Front height: 6<sup>1</sup>/<sub>2</sub>"; Back height: 10"



Size	Waist Measurement	Product No.
Small	30"-32"	89550 S
Medium	34"-36"	89550 M
Large	38"-40"	89550 L
X-Large	42"-44"	89550 XL
2X-Large	46"-48"	89550 XXL
3X-Large	50"-52"	89550 XXXL







Soft and  
Semi-Rigid

Soft and  
Semi-Rigid

## Sacral and Lumbosacral Supports (continued)

Bell-Horn	<b>Men's Sacro-Cinch with Stays</b> <ul style="list-style-type: none"> <li>• One-way stretch elastic with hook-and-pile closure and two removable pre-bent stays</li> <li>• Separate adjustable cinch-pull strap secured to wide elastic back sling; comes with a pocket for a heat moldable insert</li> <li>• Front height: 6<sup>1</sup>/<sub>2</sub>"; Back height: 10"</li> </ul>			
	<b>Size</b>	<b>Waist Measurement</b>	<b>Product No.</b>	
	X-Small	26"-29"	<b>89310 XS</b>	
	Small	30"-32"	<b>89310 S</b>	
	Medium	34"-36"	<b>89310 M</b>	
	Large	38"-40"	<b>89310 L</b>	
	X-Large	42"-44"	<b>89310 XL</b>	
	2X-Large	46"-48"	<b>89310 XXL</b>	
3X-Large	50"-52"	<b>89310 XXXL</b>		
DeRoyal	<b>Criss-Cross Lumbo Sacral Support</b> <ul style="list-style-type: none"> <li>• Durable latex-safe elastic construction with hook-and-loop closure</li> <li>• Two elastic side pulls for optimal compression with four adjustable posterior stays</li> <li>• Back height: 12"</li> </ul>			
	<b>Size</b>	<b>Waist Measurement</b>	<b>Product No.</b>	
	Universal	26"-46"	<b>13850000</b>	
	Small	24"-28"	<b>13850005</b>	
	Small/Medium	28"-32"	<b>13850056</b>	
	Medium/Large	32"-36"	<b>13850067</b>	
	Large	36"-40"	<b>13850007</b>	
	X-Large	40"-44"	<b>13850008</b>	
	2X-Large	44"-48"	<b>13850009</b>	
3X-Large	48"-52"	<b>13850010</b>		
4X-Large	52"-56"	<b>13850011</b>		
Freeman	<b>Model 571/572/573 EZ-Fit™ Lumbosacral Support</b> <ul style="list-style-type: none"> <li>• Hook-and-pile closure</li> <li>• Overlapping hook-and-pile closure with one pair 9" preshaped steels and flexible stays in the front, side and back</li> <li>• Unique stretch cotton with flexible stays in the front, side, and back</li> <li>• <b>Model 571/572:</b> two side lace adjustment Model 571: Front height: 8"; Back height: 11"; Preshaped steels: 9"; Hip development: 2"-3" Model 572: Front height: 10"; Back height: 13"; Preshaped steels: 11"; Hip development 3"-4"</li> <li>• <b>Model 573:</b> Front height: 6<sup>1</sup>/<sub>2</sub>"; Back height: 12<sup>1</sup>/<sub>2</sub>"; Preshaped steels: 11"</li> </ul>			
	<b>Size</b>	<b>Hip Measurement</b>	<b>Product No.</b>	
			<b>571</b> <b>572</b> <b>573</b>	
	Small	32"-37"	<b>571-S</b> <b>572-S</b> <b>573-S</b>	
	Medium	35"-41"	<b>571-S</b> <b>572-S</b> <b>573-S</b>	
	Large	39"-45"	<b>571-S</b> <b>572-S</b> <b>573-S</b>	
X-Large	43"-49"	<b>571-S</b> <b>572-S</b> <b>573-S</b>		

## Sacral and Lumbosacral Supports (continued)

Freeman	<b>Model 577 EZ-Fit™ Pendulous LS Support</b>			
	<ul style="list-style-type: none"> <li>• Overlapping hook-and-pile closure with one pair 11" preshaped steels</li> <li>• Hook-and-pile, two side lace adjustment</li> <li>• Unique stretch cotton with flexible stays in the front, side, and back</li> <li>• Front height: 12"; Back height: 13"</li> </ul>			
	Size	Hip Measurement	Product No.	
	Medium	35"-41"	<b>577-M</b>	
	Large	39"-45"	<b>577-L</b>	
	X-Large	43"-49"	<b>577-XL</b>	
	2X-Large	49"-54"	<b>577-XXL</b>	
	<b>Model 108 Economy Thermoplastic Back Insert</b>			
	<ul style="list-style-type: none"> <li>• Moldable posterior panel for pocket wraparounds</li> <li>• Heat conductive plastic on the side, padded 2-ply insulating material on the other side</li> <li>• Unique stretch cotton with flexible stays in the front, side, and back</li> </ul>			
	Size	Hip Measurement	Product No.	
7 <sup>3</sup> / <sub>8</sub> " x 13 <sup>5</sup> / <sub>8</sub> "	—	<b>108-1</b>		
<b>Women's Lumbosacral Support</b>				
<ul style="list-style-type: none"> <li>• <b>Sizes: 32"-38"</b>- Above Waist: Front - 1<sup>1</sup>/<sub>2</sub>"; Back - 4<sup>1</sup>/<sub>2</sub>", Below Waist: Front - 8"; Back - 10<sup>1</sup>/<sub>2</sub>"</li> <li>• <b>Sizes: 40"-52"</b>- Above Waist: Front - 2"; Back - 4<sup>1</sup>/<sub>2</sub>", Below Waist: Front - 8"; Back - 10<sup>1</sup>/<sub>2</sub>"</li> <li>• Hook-and-pile closure with three-pull side lace; white brocade</li> <li>• Replace ? with hip measurement</li> </ul>				
Size	Hip Measurement	Product No.		
Even	32"-52"	<b>523-?</b>		
Replacement Hose Supporters (4 pack)		<b>HS1</b>		
<b>Women's Lumbosacral Support</b>				
<ul style="list-style-type: none"> <li>• <b>Sizes: 28"-38"</b>- Above Waist: Front - 1<sup>1</sup>/<sub>2</sub>", Back - 1<sup>1</sup>/<sub>2</sub>"; Below Waist: Front - 7<sup>1</sup>/<sub>2</sub>", Back - 10<sup>1</sup>/<sub>2</sub>"</li> <li>• <b>Sizes: 40"-56"</b>- Above Waist: Front - 1", Back - 2<sup>1</sup>/<sub>2</sub>"; Below Waist: Front - 8", Back - 10<sup>1</sup>/<sub>2</sub>"</li> <li>• Three 1<sup>1</sup>/<sub>2</sub>" wide cinch-pull adjustment straps for front closure</li> <li>• One pair of 10" (sizes 28"-38) or 11" (sizes 40"-56") preshaped steels with flexible stays at front, side and back</li> <li>• Replace ? with hip measurement</li> </ul>				
Size	Hip Measurement	Product No.		
Even	28"-56"	<b>556-?</b>		
Replacement Hose Supporters (4 pack)		<b>HS1</b>		
<b>Women's Cinch-It Lumbosacral Support</b>				
<ul style="list-style-type: none"> <li>• Above Waist: Front - 1<sup>1</sup>/<sub>2</sub>"; Back - 1<sup>1</sup>/<sub>2</sub>", Below Waist: Front - 7<sup>1</sup>/<sub>2</sub>"; Back - 10<sup>1</sup>/<sub>2</sub>"</li> <li>• Two elastic side pull adjustments; white polyester/cotton with elastic releases on top and bottom</li> <li>• One pair of 10" preshaped steels with flexible stays at front, side and back</li> </ul>				
Size	Hip Measurement	Product No.		
Even	28"-56"	<b>566-?</b>		
Replacement Hose Supporters (4 pack)		<b>HS1</b>		

Soft and  
Semi-Rigid

**Sacral and Lumbosacral Supports (continued)**

Soft and  
Semi-Rigid

Freeman

**Model 584 Women's Lumbosacral Support**

- Above Waist: Front - 1<sup>1</sup>/<sub>2</sub>" , Back - 3<sup>1</sup>/<sub>2</sub>"; Below Waist: Front - 7" , Back - 10<sup>1</sup>/<sub>2</sub>"
- Three 1<sup>1</sup>/<sub>2</sub>" wide cinch-pull adjustable straps for front closure
- Three-pull side lace adjustment; white polyester/cotton with elastic releases on top and bottom
- One pair of 12" preshaped steels with flexible stays at front, side and back and four stay pockets
- Replace ? with hip measurement

Size	Hip Measurement	Product No.
Even	32"-54"	<b>584-?</b>
Replacement Hose Supporters (4 pack)		<b>HS1</b>



**Model 585 Women's Lumbosacral Support**

- Same as Cinch-It Model 584 but with smaller hip development
- Above Waist: Front - 1<sup>1</sup>/<sub>2</sub>" , Back - 3<sup>1</sup>/<sub>2</sub>"; Below Waist: Front - 7<sup>1</sup>/<sub>2</sub>" , Back - 10<sup>1</sup>/<sub>2</sub>"
- Replace ? with hip measurement

Size	Hip Measurement	Product No.
Even	32"-54"	<b>585-?</b>

**Model 3556 Women's Elastic Wraparound Support**

- Above Waist: Front - 1<sup>1</sup>/<sub>2</sub>" , Back - 2<sup>1</sup>/<sub>2</sub>"; Below Waist: Front - 6<sup>1</sup>/<sub>2</sub>" , Back - 10<sup>1</sup>/<sub>2</sub>"
- Power net two-way stretch elastic with rose pattern lace elastic overlay and hook-and-pile closure
- Two removable pre-bent steels and flexible stays at front and back

Size	Hip Measurement	Product No.
X-Small	28"-31"	<b>3556-XS</b>
Small	32"-35"	<b>3556-S</b>
Medium	36"-39"	<b>3556-M</b>
Large	40"-44"	<b>3556-L</b>
X-Large	45"-48"	<b>3556-XL</b>



**Model 323 Women's Sacroiliac Support**

- **Sizes: 30"-40"**- Above Waist: Front - 0" , Back - 0"; Below Waist: Front - 7" , Back - 7<sup>1</sup>/<sub>2</sub>"
- **Sizes: 42"-46"**- Above Waist: Front - 1<sup>1</sup>/<sub>2</sub>" , Back - 0"; Below Waist: Front - 7<sup>1</sup>/<sub>2</sub>" , Back - 7<sup>1</sup>/<sub>2</sub>"
- One pull back lace adjustment with center front hook-and-pile closure; white brocade with elastic releases at bottom and flexible stays at front, side and back
- Includes removable sacral pad in water-repellent pocket
- Replace ? with hip measurement

Size	Hip Measurement	Product No.
Even	30"-46"	<b>323-?</b>
Replacement Hose Supporters (4 pack)		<b>HS5</b>
Replacement Pad (each)		<b>3080</b>



**Model 516 Men's Support**

- Above Waist: Front - 2" , Back - 4"; Below Waist: Front - 8<sup>1</sup>/<sub>2</sub>" , Back - 11"
- Three-pull side lace adjustment with snap-button with reinforcing hook-and-pile front closure; white canvas with elastic releases across top and groin; two pair of 13" preshaped steels and flexible stays at front, side and back
- Replace ? with hip measurement

Size	Hip Measurement	Product No.
Even	30"-54"	<b>516-?</b>



**Sacral and Lumbosacral Supports (continued)**

Soft and  
Semi-Rigid

Freeman

**Model 518 Men's Lumbosacral Support**

- **Sizes: 28"-38"**- Above Waist: Front - 1", Back - 3<sup>1</sup>/<sub>2</sub>"; Below Waist: Front - 7", Back - 8<sup>1</sup>/<sub>2</sub>"
- **Sizes: 40"-52"**- Above Waist: Front - 1<sup>1</sup>/<sub>2</sub>", Back - 3<sup>1</sup>/<sub>2</sub>"; Below Waist: Front - 7<sup>1</sup>/<sub>2</sub>", Back - 8<sup>1</sup>/<sub>2</sub>"
- Two-pull side lace adjustment with snap-button with reinforcing hook-and-pile front closure; white canvas with one pair of 10" preshaped steels and flexible stays at front, side and back
- Replace ? with hip measurement

Size	Hip Measurement	Product No.
Even	28"-52"	<b>518-?</b>



**Model 522 Men's Lumbosacral Support**

- **Sizes: 28"-34"**- Above Waist: Front - 1", Back - 4"; Below Waist: Front - 7<sup>1</sup>/<sub>2</sub>", Back - 10"
- **Sizes: 36"-38"**- Above Waist: Front - 1<sup>1</sup>/<sub>2</sub>", Back - 4"; Below Waist: Front - 7<sup>1</sup>/<sub>2</sub>", Back - 10"
- **Sizes: 40"-54"**- Above Waist: Front - 2", Back - 4"; Below Waist: Front - 8, Back - 10"
- Replace ? with hip measurement

Size	Hip Measurement	Product No.
Even	28"-54"	<b>522-?</b>



**Model 541 Men's Lumbosacral Support**

- **Sizes: 28"-38"**- Above Waist: Front - 1", Back - 3<sup>1</sup>/<sub>2</sub>"; Below Waist: Front - 7", Back - 8<sup>1</sup>/<sub>2</sub>"
- **Sizes: 40"-50"**- Above Waist: Front - 1<sup>1</sup>/<sub>2</sub>", Back - 3<sup>1</sup>/<sub>2</sub>"; Below Waist: Front - 7<sup>1</sup>/<sub>2</sub>", Back - 8<sup>1</sup>/<sub>2</sub>"
- Replace ? with hip measurement

Size	Hip Measurement	Product No.
Even	28"-50"	<b>541-?</b>

Replacement Perineal Straps		<b>PS</b>
-----------------------------	--	-----------



**Model 546 Men's Lumbosacral Support**

- Above Waist: Front - 1<sup>1</sup>/<sub>2</sub>", Back - 4"; Below Waist: Front - 8<sup>1</sup>/<sub>2</sub>", Back - 11"
- Three-pull side lace adjustments with four 1<sup>1</sup>/<sub>2</sub>" wide cinch-pull hook-and-pile front closure straps; white canvas with elastic releases across top and at groin
- Replace ? with hip measurement

Size	Hip Measurement	Product No.
Even	30"-54"	<b>546-?</b>

Replacement Perineal Straps		<b>PS</b>
-----------------------------	--	-----------

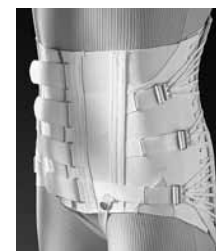

**Model 548 Men's Lumbosacral Support**

- Above Waist: Front - 1", Back - 3<sup>1</sup>/<sub>2</sub>"; Below Waist: Front - 7", Back - 8<sup>1</sup>/<sub>2</sub>"
- One pair of 10" preshaped steels and flexible stays at front, side and back with four stay pockets
- Replace ? with hip measurement

Size	Hip Measurement	Product No.
Even	28"-50"	<b>548-?</b>



**Model 562 Men's Lumbosacral Support**

- Above Waist: Front - 1<sup>1</sup>/<sub>2</sub>", Back - 4"; Below Waist: Front - 7<sup>1</sup>/<sub>2</sub>", Back - 10"
- One pair of 12" preshaped steels and flexible stays at front, side and back
- Replace ? with hip measurement

Size	Hip Measurement	Product No.
Even	30"-54"	<b>562-?</b>



**Sacral and Lumbosacral Supports (continued)**

Soft and  
Semi-Rigid

Freeman

**Model 3515/3516 Women's Dorsolumbar Support**

- Above Waist: Front - 1<sup>1</sup>/<sub>2</sub>", Back - 9"; Below Waist: Front - 6<sup>1</sup>/<sub>2</sub>", Back - 9"
- Front hook-and-pile closure with preshaped 15" steels
- Model 3515 is the same support with slide buckle shoulder straps

Size	Hip Measurement	Product No.	
		Model 3515	Model 3516
X-Small	28"-31"	<b>3515-XS</b>	<b>3516-XS</b>
Small	32"-35"	<b>3515-S</b>	<b>3516-S</b>
Medium	36"-39"	<b>3515-M</b>	<b>3516-M</b>
Large	40"-44"	<b>3515-L</b>	<b>3516-L</b>
X-Large	45"-48"	<b>3515-XL</b>	<b>3516-XL</b>



**Model 5615 Women's Dorsolumbar Support**

- Cinch-it front closure with three-pull side lace adjustment
- Above Waist: Front - 0", Back - 9"; Below Waist: Front - 7", Back - 9"
- Elastic releases with 16" preshaped steels and flexible stays in front, side and back
- Replace ? with hip measurement

Size	Hip Measurement	Product No.
Even	28"-50"	<b>5615-?</b>



**Model 579 EZ-Fit Dorsolumbar Support**

- Two-pull side lace hook-and-pile adjustment with front overlapping hook-and-pile closure
- Preshaped steels: one pair 18", flexible stays in front, side and back
- Front height: 9", Back height: 20<sup>1</sup>/<sub>2</sub>"

Size	Hip Measurement	Product No.
Small	32"-37"	<b>579-S</b>
Medium	35"-41"	<b>579-M</b>
Large	39"-45"	<b>579-L</b>
X-Large	43"-49"	<b>579-XL</b>



**Model 5611 Men's Dorsolumbar Support**

- **Sizes: 32"-38"**- Above Waist: Front - 2", Back - 11<sup>1</sup>/<sub>2</sub>"; Below Waist: Front - 7<sup>3</sup>/<sub>4</sub>", Back - 10<sup>3</sup>/<sub>4</sub>"
- **Sizes: 40"-48"**- Above Waist: Front - 2<sup>1</sup>/<sub>2</sub>", Back - 11<sup>1</sup>/<sub>2</sub>"; Below Waist: Front - 8<sup>1</sup>/<sub>4</sub>", Back - 10<sup>3</sup>/<sub>4</sub>"
- Three-pull side lace adjustments with four 1<sup>1</sup>/<sub>2</sub>" wide cinch-pull hook-and-pile front closure straps; white canvas with elastic releases across top and at groin
- One pair 19" with flexible stays in front, side and back
- Replace ? with hip measurement

Size	Hip Measurement	Product No.
Even	30"-54"	<b>5611-?</b>



**Model 3510 Men's Dorsolumbar Support**



- Above Waist: Front - 1", Back - 10"; Below Waist: Front - 8", Back - 10"
- Hook-and-pile front closure with one pair of 18" preshaped steels with flexible stays in front and back

Size	Hip Measurement	Product No.
Small	30"-34"	<b>3510-S</b>
Medium	34"-38"	<b>3510-M</b>
Large	38"-42"	<b>3510-L</b>
X-Large	42"-46"	<b>3510-XL</b>
2X-Large	46"-50"	<b>3510-XXL</b>





**Sacral and Lumbosacral Supports (continued)**

<b>Hely &amp; Weber</b>	<p><b>LEI Back Lumbosacral Brace</b></p> <ul style="list-style-type: none"> <li>• Kuhl perforated neoprene construction with 4-way stretch</li> <li>• Double pull with four flexible spiral stays</li> <li>• Front height: 10", Back height: 10"</li> <li>• Measure widest part of hip/waist</li> </ul>			
	<b>Size</b>	<b>Hip Measurement</b>	<b>Product No.</b>	
	X-Small	24"-34"	<b>5809XS</b>	
	Regular	32"-46"	<b>5809BLK</b>	
	X-Large	42"-58"	<b>5809XL</b>	
	2X-Large	48"-64"	<b>5809XXL</b>	
	<p><b>Elastic Lumbar Support</b></p> <ul style="list-style-type: none"> <li>• Heavy elastic construction with double side pulls that cross in the front</li> <li>• Elastic pocket accommodates thermoplastic insert model 106 (sold separate)</li> <li>• Measure widest part of hip/waist</li> </ul>			 <p style="text-align: center;"><i>Front View</i></p> <p style="text-align: center;"><i>Rear View</i></p>
	<b>Size</b>	<b>Hip Measurement</b>	<b>Product No.</b>	
	X-Small	25"-29"	<b>102XS</b>	
	Small	29"-33"	<b>102S</b>	
Medium	33"-37"	<b>102M</b>		
Large	37"-41"	<b>102L</b>		
X-Large	41"-45"	<b>102XL</b>		
2X-Large	45"-49"	<b>102XXL</b>		
<b>New Options Sports</b>	<p><b>Model L1 Elastic Double-Side Pull Lumbar Support</b></p> <ul style="list-style-type: none"> <li>• 9" wide elastic belt</li> <li>• Two 4" wide adjustable side pulls that overlap in front</li> <li>• 1/8" nylon, two side neoprene pocket accommodates optional inserts</li> </ul>			
	<b>Size</b>	<b>Waist Measurement</b>	<b>Product No.</b>	
	X-Small	22"-26"	<b>L1 XS</b>	
	Small	26-30"	<b>L1 S</b>	
	Medium	30"-34"	<b>L1 M</b>	
	Large	34"-38"	<b>L1 L</b>	
	X-Large	38"-42"	<b>L1 XL</b>	
	2X-Large	42"-46"	<b>L1 XXL</b>	
	3X-Large	46"-50"	<b>L1 XXXL</b>	
	4X-Large	50"-54"	<b>L1 XXXXL</b>	
	3/16" Neoprene Insert with 1/4" Sewn in Pad		<b>L9</b>	
	Heat Moldable Insert		<b>L10</b>	
	Gel Insert		<b>L24</b>	

Soft and Semi-Rigid

**Sacral and Lumbosacral Supports (continued)**

Soft and  
Semi-Rigid

New Options Sports

**Model L5N Elastic Double Side-Pull Lumbar Support**

- 12" wide elastic belt
- Two 4" wide adjustable side pulls that overlap in front
- 1/8" nylon, two side neoprene pocket for optional insert L11

Size	Hip Measurement	Product No.	
X-Small	22"-26"	<b>L5N XS</b>	
Small	26-30"	<b>L5N S</b>	
Medium	30"-34"	<b>L5N M</b>	
Large	34"-38"	<b>L5N L</b>	
X-Large	38"-42"	<b>L5N XL</b>	
2X-Large	42"-46"	<b>L5N XXL</b>	
3X-Large	46"-50"	<b>L5N XXXL</b>	
4X-Large	50"-54"	<b>L5N XXXXL</b>	
Heat Moldable Insert		<b>L11</b>	



Ossur Americas

**Tri Back® Back Support**

- Utilizes the breathable Tri Back stretch mesh material combines with supportive "V" shaped elastic configuration
- Available in white with gray trim or black with blue trim

Size	Hip Measurement	Product No.	
		White/Gray	Black/Blue
Small	22"-28"	<b>219023</b>	<b>219023BLU</b>
Medium	28"-34"	<b>219025</b>	<b>219025BLU</b>
Large	34"-40"	<b>219027</b>	<b>219027BLU</b>
X-Large	40"-46"	<b>219028</b>	<b>219028BLU</b>
2X-Large	46"-56"	<b>219029</b>	<b>219029BLU</b>
3X-Large	56"-60"	<b>219029S</b>	<b>219029SBLU</b>



**AIRFORM® Inflatable Back Support**

- Adjustable air bladder
- Self contained pneumatic system is low profile and easy to use
- Mesh panels and ventilation holes increase breathability and enhance comfort
- Overlapping double pull strap design

**FORMFIT® Back Support**



- 3-dimensional molding technology creates a firm, yet comfortable lumbar pad
- Mesh panels and ventilation holes increase breathability and enhance comfort
- Gripper strips are mechanically sewn inside each support

Size	Hip Measurement	Product No.	
		FORMFIT	AIRFORM
Small	25"-30"	<b>209133</b>	<b>209143</b>
Medium	30"-34"	<b>209135</b>	<b>209145</b>
Large	34"-38"	<b>209137</b>	<b>209147</b>
X-Large	38"-42"	<b>209138</b>	<b>209148</b>
2X-Large	42"-56"	<b>209139</b>	<b>209149</b>
3X-Large	56"-60"	—	<b>209151</b>



**Sacral and Lumbosacral Supports (continued)**

Soft and  
Semi-Rigid

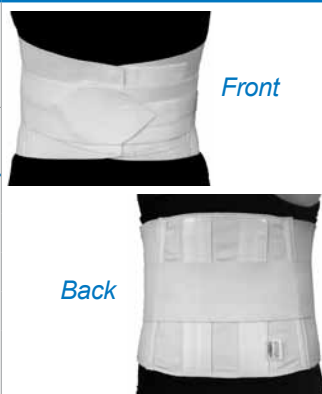
ProCare (DJO)	<b>10" Double-Pull Sacro-Lumbar Support</b> • Premium all elastic construction with compression straps • Four 9" posterior plastic stays				
	<b>Size</b>	<b>Hip Measurement</b>	<b>Product No.</b>		
	Small	31"-34"	<b>79-89003</b>		
	Medium	35"-38"	<b>79-89005</b>		
	Medium/Large	36"-42"	<b>79-89006</b>		
	Large	39"-42"	<b>79-89007</b>		
	X-Large	43"-46"	<b>79-89008</b>		
	2X-Large	47"-54"	<b>79-89009</b>		
	3X-Large	55"-60"	<b>79-89009-10</b>		
	<b>Sacro-Lumbar Support with Compression Straps</b> • Low profile 9" elastic support, double side pull compression straps • Neoprene posterior panel accommodates ComfortFORM Moldable insert <b>79-89120</b>				
<b>Size</b>	<b>Hip Measurement</b>	<b>Product No.</b>			
		<b>White</b>	<b>Black</b>		
X-Small	18"-24"	—	<b>79-82502</b>		
Small	24"-33"	<b>79-89263</b>	<b>79-82503</b>		
Medium	33"-39"	<b>79-89265</b>	<b>79-82505</b>		
Large	39"-45"	<b>79-89267</b>	<b>79-82507</b>		
X-Large	45"-53"	<b>79-89268</b>	<b>79-82508</b>		
2X-Large	53"-59"	<b>79-89269</b>	<b>79-82509</b>		
3X-Large	59"-65"	—	<b>79-82509-10</b>		
4X-Large	65"-70"	—	<b>79-82509-11</b>		
<b>Powerbelt™ Back Support</b> • Durable mesh elastic construction with built in lower back pad • Lock strap with quick release buckle easily tightens belt					
<b>Size</b>	<b>Hip Measurement</b>	<b>Product No.</b>			
X-Small	20"-26"	<b>79-89342</b>			
Small	26"-34"	<b>79-89343</b>			
Medium	34"-42"	<b>79-89345</b>			
Large	42"-52"	<b>79-89347</b>			
X-Large	52"-62"	<b>79-89348</b>			
Professional Products	<b>10" Lumbosacral Support - Herringbone Twill Back</b> • 10" back tapers to 6" front with 4 plastic or aluminum side panel stays • Specify size when ordering			 <p><i>Front</i></p> <p><i>Back</i></p>	
	<b>Size</b>	<b>Hip Measurement</b>	<b>Stays Product No.</b>		
			<b>Aluminum</b>		<b>Plastic</b>
	Small	28"-32"	<b>00445</b>		<b>00445-P</b>
	Medium	32"-36"			
	Large	36"-40"			
	X-Large	40"-44"			
2X-Large	44"-48"				
3X-Large	48"-52"				

**Sacral and Lumbosacral Supports (continued)**

Soft and  
Semi-Rigid

Scott Specialties

**Criss-Cross Lumbar Support**

- Overlapping abdominal straps with 3 separate closures
- Accepts 0101, 0102 and 0103 moldable inserts

Size	Hip Measurement	Product No.
X-Small	24"-29"	<b>0130BEI-XS</b>
Small	30"-34"	<b>0130BEI-SM</b>
Medium	35"-39"	<b>0130BEI-MD</b>
Large	40"-45"	<b>0130BEI-LG</b>
X-Large	46"-52"	<b>0130BEI-XL</b>
2X-Large	53"-60"	<b>0130BEI-XXL</b>



**Lumbar Thoracic Support**

- Contoured at top and bottom to 8" in front, 20" at spine
- Short is 6" in front and 20" at spine
- Back lumbar width is 12"
- Abdominal strap provides additional support

Size	Waist Measurement	Product No.	
		Contoured	Short
Small	24"-30"	<b>0241-SM</b>	<b>0240-SM</b>
Medium	32"-38"	<b>0241-MD</b>	<b>0240-MD</b>
Large	40"-46"	<b>0241-LG</b>	<b>0240-LG</b>
X-Large	48"-54"	<b>0241-XL</b>	<b>0240-XL</b>
2X-Large	54"-60"	<b>0241-XXL</b>	<b>0240-XXL</b>



Truform

**464-VHS Men's Lumbosacral with Hook and Loop Front**

- Contact closure tabs in front for thin to average figures; short height
- Replace ? with hip measurement

Size	Hip Measurement	Product No.
Even	28"-50"	<b>0464VHS-?</b>



**465-VHS Men's Lumbosacral with Hook and Loop Front**

- Basic three pull LS for average to stocky figures
- Replace ? with hip measurement

Size	Hip Measurement	Product No.
Even	30"-56"	<b>0465VHS-?</b>



**609-VHS Women's Lumbosacral with Hook and Loop Front**

- Basic three pull LS for average figures and average height
- Replace ? with hip measurement

Size	Hip Measurement	Product No.
Even	30"-56"	<b>0609VHS-?</b>







**609-HS Women's Lumbosacral with Hook and Loop Front**

- Basic three pull LS for various figure types
- Replace ? with hip measurement

Size	Hip Measurement	Product No.
Even	30"-56"	<b>0609HS-?</b>



**Sacral and Lumbosacral Supports (continued)**

<b>Truform</b>	<p><b>Mesh Elastic Sacroiliac Support (for all figure types)</b></p> <ul style="list-style-type: none"> <li>• Front height: 4", Back height: 6"</li> <li>• Removable sacroiliac support pad</li> </ul>			
	<b>Size</b>	<b>Hip Measurement</b>	<b>Product No.</b>	
	Small	26"-30"	<b>0574-S</b>	
	Medium	32"-36"	<b>0574-M</b>	
	X-Large	44"-48"	<b>0574-XL</b>	
<b>Trulife</b>	<p><b>Camp XXI Semi-Rigid Posterior Lumbosacral Support</b></p> <ul style="list-style-type: none"> <li>• Front height: 8", Back height: 10<sup>1</sup>/<sub>2</sub>"</li> <li>• Removable sacroiliac support pad</li> </ul>			
	<b>Size</b>	<b>Hip Measurement</b>	<b>Product No.</b>	
	Small	29 <sup>1</sup> / <sub>2</sub> "-33 <sup>2</sup> / <sub>5</sub> "	<b>0043002</b>	
	Medium	33 <sup>2</sup> / <sub>5</sub> "-37 <sup>2</sup> / <sub>5</sub> "	<b>0043003</b>	
	Large	37 <sup>2</sup> / <sub>5</sub> "-41 <sup>3</sup> / <sub>10</sub> "	<b>0043004</b>	
	X-Large	39 <sup>3</sup> / <sub>10</sub> "-43 <sup>3</sup> / <sub>10</sub> "	<b>0043005</b>	
	2X-Large	43 <sup>3</sup> / <sub>10</sub> "-47 <sup>1</sup> / <sub>5</sub> "	<b>0043006</b>	
	<p><b>Average Hip Support for Short Torso</b></p> <ul style="list-style-type: none"> <li>• Includes TABS ONLY for detachable hose support</li> <li>• Elastic side releases (top and bottom)</li> <li>• Front height: 9", Back height: 15"</li> </ul>			
	<b>Size</b>	<b>Hip Measurement</b>	<b>Product No.</b>	
	Even	34"-48"	<b>09474?</b>	
	<p><b>Straight Hip M Line Support for Short Torso</b></p> <ul style="list-style-type: none"> <li>• Double sided adjustments</li> <li>• Front height: 8<sup>1</sup>/<sub>2</sub>", Back height: 12"</li> </ul>			
	<b>Size</b>	<b>Hip Measurement</b>	<b>Product No.</b>	
	Small	34"-36"	<b>M907302</b>	
	Medium	38"-40"	<b>M907303</b>	
	X-Large	46"-48"	<b>M907305</b>	
<p><b>Average Hip M Line Support for Average Torso</b></p> <ul style="list-style-type: none"> <li>• Triple side adjustments and elastic side releases at top and bottom</li> <li>• Front height: 8"; Back height: 15<sup>1</sup>/<sub>2</sub>"</li> <li>• Replace ? with hip measurement</li> </ul>				
<b>Size</b>	<b>Hip Measurement</b>	<b>Product No.</b>		
Small	34"-36"	<b>M907102</b>		
Medium	38"-40"	<b>M907103</b>		
Large	42"-44"	<b>M907104</b>		
X-Large	46"-48"	<b>M907105</b>		
2X-Large	50"-52"	<b>M907106</b>		
3X-Large	54"-56"	<b>M907107</b>		

Soft and Semi-Rigid

**Sacral and Lumbosacral Supports (continued)**

Soft and  
Semi-Rigid

Trulife

**Average Torso Pendulous Canvas Support for Stocky to Pendulous Build**

- Triple side adjustments
- Elastic front release and side release ay top and bottom
- Front height: 12"; Back height: 15<sup>1</sup>/<sub>2</sub>"
- Closure: Center front hook and snap button
- 38"-44" has 13<sup>1</sup>/<sub>2</sub>" x 5<sup>5</sup>/<sub>8</sub>" steel stays
- 46"-54" has 14" x 5<sup>5</sup>/<sub>8</sub>" steel stays
- Replace ? with hip measurement

Size	Hip Measurement	Product No.
Even	38"-54"	<b>09368?</b>



**Lumbosacral OrthoMold Spinal Orthosis**

- Standard Model:  
Front Height: 9"; Back Height: 9"
- Contoured Model:  
Front Height: 7"; Back Height: 9"
- Optional inserts available for more rigid control

Size	Hip Measurement	Product No.	
		Standard	Contoured
X-Small	24"-30"	<b>OBX100-000</b>	<b>OBX110-000</b>
Small	30"-36"	<b>OBX100-010</b>	<b>OBX110-010</b>
Medium	36"-46"	<b>OBX100-020</b>	<b>OBX110-020</b>
Large	46"-65"	<b>OBX100-030</b>	<b>OBX110-030</b>
X-Large	65"-75"	<b>OBX100-040</b>	<b>OBX110-040</b>



**Lumbosacral Rigid Back Support, Low Temp**

- Moldable Support
- Height: 7"; Width: 14"
- Optional inserts available for more rigid control

Size	Hip Measurement	Product No.
—	—	<b>OXI101-000</b>

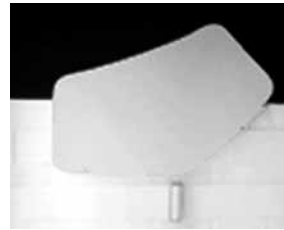





**OrthoMold Lite Spinal Orthosis**

- Front height: 6<sup>1</sup>/<sub>2</sub>"; Back height: 9"
- Low temperature, moldable rigid back support available (OXI150-000)

Size	Hip Measurement	Product No.
X-Small	30"-33"	<b>OBX150-000</b>
Small	33"-36"	<b>OBX150-010</b>
Medium	36"-39"	<b>OBX150-020</b>
Large	39"-43"	<b>OBX150-030</b>
X-Large	43"-47"	<b>OBX150-040</b>
2X-Large	47"-52"	<b>OBX150-050</b>



## Sacral and Lumbosacral Supports (continued)

Trulife	<b>Platinum Pendulous Lumbosacral Support</b>			
	<ul style="list-style-type: none"> <li>• Cupped front lifts and supports abdomen to alleviate spinal pressure</li> <li>• Antibacterial TruTex promotes freshness</li> <li>• Front height: 10<sup>1</sup>/<sub>2</sub>"; Back height: 11"</li> </ul>			
	<b>Size</b>	<b>Hip Measurement</b>	<b>Product No.</b>	
	Medium	37"-41"	<b>PT13403</b>	
	Large	41"-45"	<b>PT13404</b>	
	X-Large	45"-49"	<b>PT13405</b>	
	2X-Large	49"-53"	<b>PT13406</b>	
	3X-Large	53"-57"	<b>PT13407</b>	
	<b>Camp XXI Short Lumbosacral Support</b>			
	<ul style="list-style-type: none"> <li>• Front Height: 8"; Back Height: 11"</li> </ul>			
<b>Size</b>	<b>Hip Measurement</b>	<b>Product No.</b>		
Small	29 <sup>1</sup> / <sub>2</sub> "-33 <sup>2</sup> / <sub>5</sub> "	<b>0043202</b>		
Medium	33 <sup>2</sup> / <sub>5</sub> "-37 <sup>2</sup> / <sub>5</sub> "	<b>0043203</b>		
Large	37 <sup>2</sup> / <sub>5</sub> "-41 <sup>3</sup> / <sub>10</sub> "	<b>0043204</b>		
X-Large	39 <sup>3</sup> / <sub>10</sub> "-43 <sup>3</sup> / <sub>10</sub> "	<b>0043205</b>		
2X-Large	43 <sup>3</sup> / <sub>10</sub> "-47 <sup>1</sup> / <sub>5</sub> "	<b>0043206</b>		
<b>Replacement Panel - Rigid Posterior Panel</b>				
<b>Size</b>	<b>Hip Measurement</b>	<b>Product No.</b>		
Small	—	<b>0073802</b>		
Medium/Large	—	<b>0073803</b>		
X-Large/2X-Large	—	<b>0073804</b>		
<b>Camp XXI Lumbosacral Support</b>				
<ul style="list-style-type: none"> <li>• Front Height: 10"; Back Height: 13"</li> </ul>				
<b>Size</b>	<b>Hip Measurement</b>	<b>Product No.</b>		
Small	29 <sup>1</sup> / <sub>2</sub> "-33 <sup>2</sup> / <sub>5</sub> "	<b>0043302</b>		
Medium	33 <sup>2</sup> / <sub>5</sub> "-37 <sup>2</sup> / <sub>5</sub> "	<b>0043303</b>		
Large	37 <sup>2</sup> / <sub>5</sub> "-41 <sup>3</sup> / <sub>10</sub> "	<b>0043304</b>		
X-Large	39 <sup>3</sup> / <sub>10</sub> "- 43 <sup>3</sup> / <sub>10</sub> "	<b>0043305</b>		
2X-Large	43 <sup>3</sup> / <sub>10</sub> "-47 <sup>1</sup> / <sub>5</sub> "	<b>0043306</b>		
<b>Pendulous Lumbosacral Support</b>				
<ul style="list-style-type: none"> <li>• Cupped front section accommodating pendulous abdomen</li> <li>• Front height: 12"; Back height: 13"</li> </ul>				
<b>Size</b>	<b>Hip Measurement</b>	<b>Product No.</b>		
Small	29 <sup>1</sup> / <sub>2</sub> "-33 <sup>2</sup> / <sub>5</sub> "	<b>0043402</b>		
Medium	33 <sup>2</sup> / <sub>5</sub> "-37 <sup>2</sup> / <sub>5</sub> "	<b>0043403</b>		
Large	37 <sup>2</sup> / <sub>5</sub> "-41 <sup>3</sup> / <sub>10</sub> "	<b>0043404</b>		
X-Large	39 <sup>3</sup> / <sub>10</sub> "- 43 <sup>3</sup> / <sub>10</sub> "	<b>0043405</b>		
2X-Large	43 <sup>3</sup> / <sub>10</sub> "-47 <sup>1</sup> / <sub>5</sub> "	<b>0043406</b>		

Soft and  
Semi-Rigid

**Sacral and Lumbosacral Supports (continued)**

Soft and  
Semi-Rigid

Trulife

**Straight Hip Short Front Support for Average Torso**

- Double side adjustments
- Top and bottom elastic side releases
- Front height: 6<sup>1</sup>/<sub>2</sub>"; Back height: 11<sup>1</sup>/<sub>2</sub>"
- Includes: Tabs for hose support and 1 pair of casings
- Replace ? with hip measurement

Size	Hip Measurement	Product No.
Even	30"-44"	<b>01374?</b>



**Full Hip M Line Support for Short Torso**

- Triple side adjustments
- Elastic releases at top and bottom
- Front Height: 9"; Back Height: 14<sup>1</sup>/<sub>2</sub>"

Size	Hip Measurement	Product No.
Small	34"-36"	<b>M947802</b>
Medium	38"-40"	<b>M947803</b>
Large	42"-44"	<b>M947804</b>
X-Large	46"-48"	<b>M947805</b>
2X-Large	50"-52"	<b>M947806</b>
3X-Large	54"-56"	<b>M947807</b>



**Short Torso M Line Support for Average to Stocky Build**

- Triple side adjustments
- Elastic releases at top and bottom
- Front Height: 9<sup>1</sup>/<sub>2</sub>"; Back Height: 11<sup>1</sup>/<sub>2</sub>"
- One pair of casings

Size	Hip Measurement	Product No.
Small	30"-32"	<b>M926202</b>
Medium	34"-36"	<b>M926203</b>
Large	38"-40"	<b>M926204</b>
X-Large	42"-44"	<b>M926205</b>
2X-Large	46"-48"	<b>M926206</b>
3X-Large	50"-52"	<b>M926207</b>



**Average Torso M Line Support Average to Stocky Build**





- Triple side adjustments
- Elastic releases at top and bottom
- Front height: 11"; Back height: 16"

Size	Hip Measurement	Product No.
Small	30"-32"	<b>M966702</b>
Medium	34"-36"	<b>M966703</b>
Large	38"-40"	<b>M966704</b>
X-Large	42"-44"	<b>M966705</b>
2X-Large	46"-48"	<b>M966706</b>
3X-Large	50"-52"	<b>M966707</b>





**Sacral and Lumbosacral Supports (continued)**

<b>Trulife</b>	<b>OrthoMold Thoracolumbar Binder</b> • Front height: 12" (OBX200), 10" (OBX210); Back height: 12"				
			<b>Product No.</b>		
	<b>Size</b>	<b>Hip Measurement</b>	<b>Standard</b>		<b>Contoured</b>
	Small	24"-30"	<b>OBX200-000</b>		<b>OBX210-000</b>
	Medium	32"-38"	<b>OBX200-010</b>		<b>OBX210-010</b>
	Large	40"-46"	<b>OBX200-020</b>		<b>OBX210-020</b>
	X-Large	48"-54"	<b>OBX200-030</b>	<b>OBX210-030</b>	
	2X-Large	54"-60"	<b>OBX200-040</b>	<b>OBX210-040</b>	
	Thoracolumbar Rigid Back Support			<b>OXI201-000</b>	
	<b>Platinum Thoracolumbar Support</b> • Adjustable, discreet thoracic, lumbar, sacral and abdominal support • Stays and boning provide additional back support • Antibacterial TruTex promotes freshness • Front height: 9", Back height: 22"				
		<b>Product No.</b>			
<b>Size</b>	<b>Hip Measurement</b>				
Small	29 <sup>1</sup> / <sub>2</sub> "-33 <sup>1</sup> / <sub>2</sub> "	<b>PT13702</b>			
Medium	33 <sup>1</sup> / <sub>2</sub> "-37 <sup>1</sup> / <sub>2</sub> "	<b>PT13703</b>			
Large	37 <sup>1</sup> / <sub>2</sub> "-41 <sup>1</sup> / <sub>2</sub> "	<b>PT13704</b>			
X-Large	41 <sup>1</sup> / <sub>2</sub> "-45 <sup>1</sup> / <sub>2</sub> "	<b>PT13705</b>			
2X-Large	45 <sup>1</sup> / <sub>2</sub> "-49 <sup>1</sup> / <sub>2</sub> "	<b>PT13706</b>			
<b>Camp XXI Thoracolumbar Support</b> • Front height: 8", Back height: 20" • Cross-over straps attach in front and distribute pressure evenly • Contoured posterior steel stays provide additional support					
		<b>Product No.</b>			
<b>Size</b>	<b>Hip Measurement</b>				
Small	29 <sup>1</sup> / <sub>2</sub> "-33 <sup>2</sup> / <sub>5</sub> "	<b>0043702</b>			
Medium	33 <sup>2</sup> / <sub>5</sub> "-37 <sup>2</sup> / <sub>5</sub> "	<b>0043703</b>			
Large	37 <sup>2</sup> / <sub>5</sub> "-41 <sup>3</sup> / <sub>10</sub> "	<b>0043704</b>			
X-Large	39 <sup>3</sup> / <sub>10</sub> "-43 <sup>3</sup> / <sub>10</sub> "	<b>0043705</b>			
2X-Large	43 <sup>3</sup> / <sub>10</sub> "-47 <sup>1</sup> / <sub>5</sub> "	<b>0043706</b>			
<b>Platinum Posture Training Support</b> • Re-educates muscles • Antibacterial TruTex promotes freshness • Includes one 1 lb weight and three <sup>1</sup> / <sub>4</sub> lb weights					
		<b>Product No.</b>			
<b>Size</b>	<b>Hip Measurement</b>				
One size fits most	—	<b>PT165</b>			
1 lb Replacement Weight			<b>PT165-01</b>		
<sup>1</sup> / <sub>4</sub> Replacement Weight, 3 per pack			<b>PT165-04</b>		

Soft and Semi-Rigid

**Sacral and Lumbosacral Supports (continued)**

Soft and  
Semi-Rigid

Trulife

**Fast-Wrap Thoracolumbar Support**

- Lower cinch straps adjust level of support
- Padded, adjustable shoulder straps
- Contoured posterior steel 17" stays
- Front height: 7", Back height: 21"

Size	Hip Measurement	Product No.
Small	32"-36"	0078002
Medium	38"-42"	0078003
Large	44"-48"	0078004
X-Large	50"-52"	0078005
2X-Large	54"-56"	0078006



**10" Deluxe Back Support with Moldable Inserts**

- Additional 4" elastic tension strap
- Front height: 7"; Back height: 10"
- Insert sold separately, one size (82-110P)

Size	Hip Measurement	Product No.
Small	29"-33"	82-DX10-SM
Medium	33"-37"	82-DX10-MD
Medium/Large	37"-41"	82-DX10-MD/LG
Large	41"-45"	82-DX10-LG
X-Large	45"-49"	82-DX10-XL
2X-Large	49"-53"	82-DX10-XXL



**FULLBACK XPA Back Support with Moldable Inserts**

- 6" front height

Size	Measurements	Product No.	
		Black	White
<b>8" Back Support</b>			
Small	29"-33"	XPA-8B-SM	XPA-8W-SM
Medium	33"-37"	XPA-8B-MD	XPA-8W-MD
Large	37"-41"	XPA-8B-LG	XPA-8W-LG
X-Large	41"-45"	XPA-8B-XL	XPA-8W-XL
2X-Large	45"-49"	XPA-8B-2XL	XPA-8W-2XL
3X-Large	49"-53"	XPA-8B-3XL	XPA-8W-3XL
4X-Large	53"-57"	XPA-8B-4XL	XPA-8W-4XL
5X-Large	57"-61"	XPA-8B-5XL	XPA-8W-5XL
<b>10" Back Support</b>			
Small	29"-33"	XPA-10B-SM	XPA-10W-SM
Medium	33"-37"	XPA-10B-MD	XPA-10W-MD
Large	37"-41"	XPA-10B-LG	XPA-10W-LG
X-Large	41"-45"	XPA-10B-XL	XPA-10W-XL
2X-Large	45"-49"	XPA-10B-XXL	XPA-10W-XXL
3X-Large	49"-53"	XPA-10B-3XL	XPA-10W-3XL
4X-Large	53"-57"	XPA-10B-4XL	XPA-10W-4XL
5X-Large	57"-61"	XPA-10B-5XL	XPA-10W-5XL



US Orthotics

Soft and  
Semi-Rigid

### Sacral and Lumbosacral Supports (continued)

US Orthotics	<b>FULLBACK XPA Back Support with Moldable Inserts (continued)</b>			
	• 6" front height			
	Size	Measurements	Product No.	
			Black	White
	<b>12" Back Support</b>			
	Small	29"-33"	<b>XPA-12B-SM</b>	<b>XPA-12W-SM</b>
	Medium	33"-37"	<b>XPA-12B-MD</b>	<b>XPA-12W-MD</b>
	Large	37"-41"	<b>XPA-12B-LG</b>	<b>XPA-12W-LG</b>
	X-Large	41"-45"	<b>XPA-12B-XL</b>	<b>XPA-12W-XL</b>
	2X-Large	45"-49"	<b>XPA-12B-XXL</b>	<b>XPA-12W-XXL</b>
3X-Large	49"-53"	<b>XPA-12B-3XL</b>	<b>XPA-12W-3XL</b>	
4X-Large	53"-57"	<b>XPA-12B-4XL</b>	<b>XPA-12W-4XL</b>	
5X-Large	57"-61"	<b>XPA-12B-5XL</b>	<b>XPA-12W-5XL</b>	





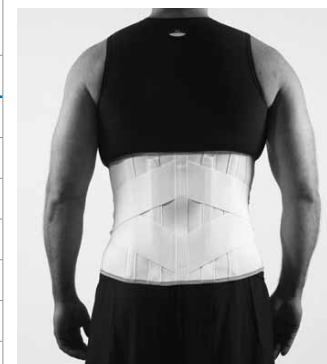

### Elasticized Lower Back Bracing

- Ideal for lumbar strains/sprains
- Compresses and stabilizes sacral and abdominal regions



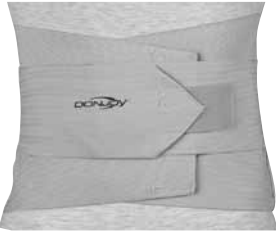

Corflex	<b>V-Lock Back Support</b>			
	• Double elastic v-shaped pull with contoured front			
	• Includes plastic and optional aluminum stays			
	Size	Waist Measurement	Product No.	
	X-Small	18"-24"	<b>35-1760</b>	
	Small	24"-30"	<b>35-1761</b>	
	Medium	30"-36"	<b>35-1762</b>	
	Large	36"-42"	<b>35-1763</b>	
	X-Large	42"-48"	<b>35-1764</b>	
	2X-Large	48"-52"	<b>35-1765</b>	
3X-Large	52"-56"	<b>35-1766</b>		
4X-Large	56"-60"	<b>35-1767</b>		
	<b>Back-2-Form Support</b>			
	• Tapered elastic panel with elastic back panel and pocket for thermoplastic insert, gel pack or pressure pad (sold separately)			
	• Double-pull tension straps or web strap			
	Size	Hip Circumference	Product No.	
			Without Strap	With Strap
	X-Small	18"-24"	<b>35-1840</b>	<b>35-1850</b>
	Small	24"-30"	<b>35-1841</b>	<b>35-1851</b>
	Medium	30"-36"	<b>35-1842</b>	<b>35-1852</b>
	Large	36"-42"	<b>35-1843</b>	<b>35-1853</b>
	X-Large	42"-48"	<b>35-1844</b>	<b>35-1854</b>
2X-Large	48"-52"	<b>35-1845</b>	<b>35-1855</b>	
3X-Large	52"-56"	<b>35-1846</b>	<b>35-1856</b>	
4X-Large	56"-60"	<b>35-1847</b>	<b>35-1857</b>	

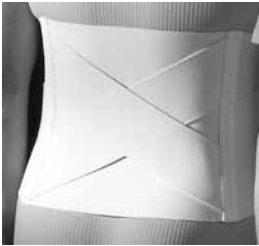

**Elasticized Lower Back Bracing (continued)**

<b>DonJoy (DJO)</b>	<b>Elastic Lumbar Support</b>			
	<ul style="list-style-type: none"> <li>• Neoprene with foam lumbar pad</li> <li>• Additional side pulls</li> </ul>			
	<b>Size</b>	<b>Waist Measurement</b>	<b>Product No.</b>	
	X-Small	18"-24"	<b>11-0466-1</b>	
	Small	24"-30"	<b>11-0466-2</b>	
	Medium	30"-36"	<b>11-0466-3</b>	
	Large	36"-42"	<b>11-0466-4</b>	
<b>Freeman</b>	<b>Model 950 Stress Belt Elastic Wraparound</b>			
	<ul style="list-style-type: none"> <li>• Two-way stretchable mesh elastic with hook-and-pile closure with separate adjustable waist band and posterior stays</li> <li>• Front height: 5<sup>1</sup>/<sub>2</sub>", Back height: 9"</li> <li>• Color: Beige</li> </ul>			
	<b>Size</b>	<b>Hip Measurement</b>	<b>Product No.</b>	
	Small	30"-34"	<b>950-S</b>	
	Medium	34"-39"	<b>950-M</b>	
	Large	39"-44"	<b>950-L</b>	
	<b>Model 966 Multiple Use Binder</b>			
	<ul style="list-style-type: none"> <li>• Durable wraparound elastic with adjustable hook-and-pile closure</li> <li>• Reverse top and bottom to use as a rib belt</li> <li>• 10" height</li> </ul>			
	<b>Size</b>	<b>Measurement at Rib Cage</b>	<b>Product No.</b>	
	Small	24"-30"	<b>966-S</b>	
	Medium	31"-36"	<b>966-M</b>	
	Large	37"-42"	<b>966-L</b>	
	X-Large	43"-48"	<b>966-XL</b>	
	<b>Model 968 Elastic Wraparound Lumbosacral with Steel Stays</b>			
<ul style="list-style-type: none"> <li>• One-way stretch elastic with hook-and-pile closure and four removable pre-bent steels</li> <li>• Front height: 8<sup>1</sup>/<sub>2</sub>", Back height: 11<sup>1</sup>/<sub>2</sub>"</li> </ul>				
<b>Size</b>	<b>Measurement at Rib Cage</b>	<b>Product No.</b>		
Small	30"-33"	<b>968-S</b>		
Medium	34"-37"	<b>968-M</b>		
Large	38"-41"	<b>968-L</b>		
X-Large	42"-45"	<b>968-XL</b>		
2X-Large	46"-50"	<b>968-XXL</b>		
3X-Large	51"-55"	<b>968-XXXL</b>		
4X-Large	56"-60"	<b>968-XXXXL</b>		

## Elasticized Lower Back Bracing (continued)

Freeman	<b>Model 969 Crisscross Wraparound</b>			
	<ul style="list-style-type: none"> <li>• One-way stretch elastic with hook-and-pile closure</li> <li>• Flexible lateral and oblique stays prevent rolling</li> <li>• Front height: 7", Back height: 10"</li> </ul>			
	Size	Hip Measurement	Product No.	
	X-Small	26"-29"	<b>969-XS</b>	
	Small	30"-33"	<b>969-S</b>	
	Medium	34"-37"	<b>969-M</b>	
Large	38"-41"	<b>969-L</b>		
X-Large	42"-45"	<b>969-XL</b>		
<b>Model 970 Elastic Sacroiliac Wraparound with Sacral Pad</b>				
<ul style="list-style-type: none"> <li>• One-way stretch contoured elastic with hook-and-pile closure</li> <li>• Flexible oblique stays on front and back</li> <li>• Replaceable sacral pad: Model 9570</li> <li>• Front height: 5<sup>1</sup>/<sub>2</sub>", Back height: 8"</li> </ul>				
Size	Hip Measurement	Product No.		
Small	30"-33"	<b>970-S</b>		
Medium	34"-37"	<b>970-M</b>		
Large	38"-41"	<b>970-L</b>		
X-Large	42"-45"	<b>970-XL</b>		
2X-Large	46"-50"	<b>970-XXL</b>		
<b>Model 971 Elastic Wraparound with Sacral Pad</b>				
<ul style="list-style-type: none"> <li>• One-way stretch elastic with hook-and-pile closure with flexible stays in back</li> <li>• Replacement pad: Model 3080</li> <li>• Front height: 4", Back height: 6"</li> </ul>				
Size	Measurement at Rib Cage	Product No.		
Small	30"-33"	<b>971-S</b>		
Medium	34"-37"	<b>971-M</b>		
Large	38"-41"	<b>971-L</b>		
X-Large	42"-45"	<b>971-XL</b>		
<b>Model 972 Elastic Wraparound</b>				
<ul style="list-style-type: none"> <li>• One-way stretch elastic with hook-and-pile closure</li> <li>• Flexible stays in back</li> <li>• Front height: 5<sup>1</sup>/<sub>2</sub>", Back height: 10"</li> </ul>				
Size	Hip Measurement	Product No.		
Small	30"-33"	<b>972-S</b>		
Medium	34"-37"	<b>972-M</b>		
Large	38"-41"	<b>972-L</b>		
X-Large	42"-45"	<b>972-XL</b>		

Soft and  
Semi-Rigid

**Elasticized Lower Back Bracing (continued)**

Soft and  
Semi-Rigid

Freeman

**Model 976/980 Cinch-Pull Wraparound Lumbosacral with Steel Stays**

- One-way stretch elastic with hook-and-pile closure and flexible stays in front and back
- Model 976: Front height: 7", Back height: 10"
- Model 980: Front height: 8<sup>1</sup>/<sub>2</sub>", Back height: 14"

Size	Hip Measurement	Product No.	
		Model 976	Model 980
X-Small	30"-33"	<b>976-S</b>	<b>980-S</b>
Small	34"-37"	<b>976-M</b>	<b>980-M</b>
Medium	38"-41"	<b>976-L</b>	<b>980-L</b>
Large	42"-45"	<b>976-XL</b>	<b>980-XL</b>
X-Large	46"-50"	<b>976-XXL</b>	<b>980-XXL</b>



**Model 977 Neoprene Pocket Lumbosacral Wraparound**

- One-way stretch contoured elastic with hook-and-pile closure
- Flexible oblique stays on front and back
- Replaceable sacral pad: Model 9570
- Front height: 6<sup>1</sup>/<sub>2</sub>", Back height: 11"

Size	Hip Measurement	Product No.
Small	28"-32"	<b>977-S</b>
Medium	32"-36"	<b>977-M</b>
Large	36"-40"	<b>977-L</b>
X-Large	40"-44"	<b>977-XL</b>
2X-Large	44"-48"	<b>977-XXL</b>
Optional thermoplastic insert		<b>107-1</b>



**Model 978 Elastic Pocket Wraparound Lumbosacral**

- Three interlocking double strength one-way stretch elastic panels with hook-and-pile closure
- Designed with posterior pocket ideal for moldable thermoplastic insert (not included) or ice pack
- Front height: 8", Back height: 8"

Size	Hip Measurement	Product No.
X-Small	26"-29"	<b>978-XS</b>
Small	30"-33"	<b>978-S</b>
Medium	34"-37"	<b>978-M</b>
Large	38"-41"	<b>978-M</b>
X-Large	42"-45"	<b>978-L</b>
2X-Large	46"-50"	<b>978-XL</b>
3X-Large	51"-55"	<b>978-XXL</b>
4X-Large	56"-60"	<b>978-XXL</b>
Optional thermoplastic insert		<b>107-1</b>



Elasticized Lower Back Bracing (continued)

Freeman

**Model 981/982 Elastic Pocket Wraparound**

- Three interlocking double strength one-way elastic panels with hook-and-pile closure
- Similar to Model 978, but with addition of encircling cinch straps and tapered front
- **Model 981:** also has tapered front; Front height: 6", Back height: 8"
- **Model 982:** Front height: 8", Back height: 8"
- Designed with posterior pocket ideal for moldable thermoplastic insert (not included) or ice pack

Size	Hip Measurement	Product No.	
		Model 981	Model 982
X-Small	26"-29"	<b>981-XS</b>	<b>982-XS</b>
Small	30"-33"	<b>981-S</b>	<b>982-S</b>
Medium	34"-37"	<b>981-M</b>	<b>982-M</b>
Large	38"-41"	<b>981-L</b>	<b>982-L</b>
X-Large	42"-45"	<b>981-XL</b>	<b>982-XL</b>
2X-Large	46"-50"	<b>981-XXL</b>	<b>982-XXL</b>



**Model 983 Elastic Pocket Wraparound with Rigid Anterior/Posterior Panels**

- Three interlocking double strength one-way stretch elastic panels with hook and pile closure
- Encircling cinch straps
- Moldable thermoplastic inserts included
- Front height: 8", Back height: 8"

Size	Waist Measurement	Product No.
X-Small	26"-29"	<b>983-XS</b>
Small	30"-33"	<b>983-S</b>
Medium	34"-37"	<b>983-M</b>
Large	38"-41"	<b>983-L</b>
X-Large	42"-45"	<b>983-XL</b>
2X-Large	46"-50"	<b>983-2XL</b>
3X-Large	51"-55"	<b>983-3XL</b>
4X-Large	56"-60"	<b>983-4XL</b>
5X-Large	61"-68"	<b>983-5XL</b>



ProCare (DJO)

**ComfortFORM Back Support**





- Low profile support constructed with power mesh elastic and molded lumbar compression pad
- Overlapping double pull straps
- Silicone gripper strips on either side of back pad
- Optional shoulder straps available; latex free
- Measurements taken from male waist or female hip

Size	Waist Measurement	Product No.
X-Small	20"-25"	<b>79-89352</b>
Small	25"-30"	<b>79-89353</b>
Medium	30"-34"	<b>79-89355</b>
Large	34"-38"	<b>79-89357</b>
X-Large	38"-42"	<b>79-89358</b>
2X-Large	42"-56"	<b>79-89359</b>
3X-Large	56"-62"	<b>79-89359-10</b>
Universal Shoulder Strap		<b>79-89350</b>

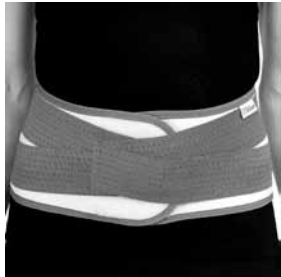

Soft and  
Semi-Rigid

**Elasticized Lower Back Bracing (continued)**



<b>Scott Specialties</b>	<b>P.R. Contour Top Lumbar Support 8"</b>			
	• Overlapping closure design with two layers of elastic for additional support			
	<b>Size</b>	<b>Waist Measurement</b>	<b>Product No.</b>	
	X-Small	16"-22"	<b>0030-XSM</b>	
	Small	24"-30"	<b>0030-SM</b>	
	Medium	32"-38"	<b>0030-MD</b>	
	Large	40"-46"	<b>0030-LG</b>	
	X-Large	48"-54"	<b>0030-XL</b>	
	2X-Large	56"-62"	<b>0030-2XL</b>	
	3X-Large	64"-69"	<b>0030-3XL</b>	
Shaped Insert			<b>107-1</b>	
Straight Insert			<b>0102</b>	
<b>Scott Specialties</b>	<b>P.R. 12" Lumbar Support</b>			
	• Made of 12" faggoted elastic for higher support			
	• Overlapping closure, contoured to 10" in front			
	<b>Size</b>	<b>Hip Measurement</b>	<b>Product No.</b>	
	X-Small	16"-22"	<b>0090-XSM</b>	
	Small	24"-30"	<b>0090-SM</b>	
	Medium	32"-38"	<b>0090-MD</b>	
	Large	40"-46"	<b>0090-LG</b>	
	X-Large	48"-54"	<b>0090-XL</b>	
	2X-Large	56"-62"	<b>0090-2XL</b>	
3X-Large	64"-69"	<b>0090-3XL</b>		
Shaped Insert			<b>0107</b>	
Straight Insert			<b>0108</b>	
<b>Trulife</b>	<b>Platinum Sacral Support</b>			
	• Adjustable, antibacterial TruTex promotes freshness			
	• Front height: 5 <sup>1</sup> / <sub>2</sub> ", Back height: 7 <sup>1</sup> / <sub>2</sub> "			
	<b>Size</b>	<b>Hip Measurement</b>	<b>Product No.</b>	
	Small	33 <sup>1</sup> / <sub>2</sub> "-37 <sup>1</sup> / <sub>2</sub> "	<b>PT13102</b>	
	Medium	37 <sup>1</sup> / <sub>2</sub> "-41 <sup>1</sup> / <sub>2</sub> "	<b>PT13103</b>	
	Large	41 <sup>1</sup> / <sub>2</sub> "-45 <sup>1</sup> / <sub>2</sub> "	<b>PT13104</b>	
	X-Large	45 <sup>1</sup> / <sub>2</sub> "-49 <sup>1</sup> / <sub>2</sub> "	<b>PT13105</b>	
	<b>Fast-Wrap Snugger Lumbosacral Support</b>			
	• Bonded anterior panel prevents rolling			
• Steel posterior stays offer rigid support				
• Front height: 9", Back height: 11"				
• Ideal for a person that might be hemi involved (have use of one arm)				
<b>Size</b>	<b>Hip Measurement</b>	<b>Product No.</b>		
Small	34"-36"	<b>0034702</b>		
Medium	38"-40"	<b>0034703</b>		
Large	42"-44"	<b>0034704</b>		
X-Large	46"-48"	<b>0034705</b>		
2X-Large	50"-52"	<b>0034706</b>		



**Elasticized Lower Back Bracing (continued)**

<b>Trulife</b>	<b>Fast-Wrap Semi-Pendulous Support with Spring Steel Stays</b>			
	<ul style="list-style-type: none"> <li>• Cupped front accommodates semi-pendulous abdomen</li> <li>• Steel stays offer additional back support</li> <li>• Ideal for geriatric or post-natal patients</li> <li>• Front height: 9", Back height: 10"</li> </ul>			
	<b>Size</b>	<b>Hip Measurement</b>	<b>Product No.</b>	
	Small	34"-36"	<b>0035702</b>	
	Medium	38"-40"	<b>0035703</b>	
	Large	42"-44"	<b>0035704</b>	
	X-Large	46"-48"	<b>0035705</b>	
2X-Large	50"-52"	<b>0035706</b>		

**Industrial Supports**

<ul style="list-style-type: none"> <li>• Compresses and stabilizes sacral and abdominal regions</li> <li>• Aids in preventing occupational injury when lifting, bending and reaching</li> </ul>				
<b>Scott Specialties</b>	<b>Black Industrial Back Support</b>			
	<ul style="list-style-type: none"> <li>• Support pad contains and lifts the abdomen</li> <li>• Heat moldable insert supports the spine and transfers the load evenly</li> <li>• Optional hook and loop attached, tear away suspenders (sold separately) add an extra dimension of safety and attach to any Black Belt</li> </ul>			
	<b>Size</b>	<b>Waist Measurement</b>	<b>Product No.</b>	
	Small	24"-30"	<b>0150-SM</b>	
	Medium	30"-34"	<b>0150-MD</b>	
	Large	34"-40"	<b>0150-LG</b>	
	X-Large	40"-46"	<b>0150-XL</b>	
2X-Large	46"-54"	<b>0150-2XL</b>		
3X-Large	54" and up	<b>0150-3XL</b>		
<b>Suspenders</b>			<b>1510</b>	
<b>Trulife</b>	<b>BACKS'PORT Industrial Support</b>			
	<ul style="list-style-type: none"> <li>• Sturdy nylon/polyester construction endures daily use</li> <li>• Easy to don on and off with hook and loop closure</li> <li>• Front height: 7", Back height: 9"</li> </ul>			
	<b>Size</b>	<b>Waist Measurement</b>	<b>Product No.</b>	
	X-Small	24"-30"	<b>0633001</b>	
	Small	30"-36"	<b>0633002</b>	
	Medium	36"-42"	<b>0633003</b>	
	Large	42"-48"	<b>0633004</b>	
X-Large	48"-54"	<b>0633005</b>		

**Abdominal Binders**

- Used for post-surgical
- Ideal for abdominal support for loss of muscle tone
- Braces abdomen to reduce muscle fatigue and strain

AliMed

**Abdominal Support**

- 3-panel width: 9", 4-panel width: 12"
- Latex free
- Color: White

Size	Waist Circumference	Product No.	
		3-Panel	4-Panel
Small/Medium	30"-45"	<b>65961</b>	<b>65963</b>
Large/X-Large	46"-62"	<b>65962</b>	<b>65964</b>



Bell-Horn

**3-Tiered Back-to-Back Binder (Universal)**

- 9" three tiered elastic belt, heat moldable insert sold separately

Size	Hip Circumference	Product No.
Small	26"-29"	<b>89780 S</b>
Medium	30"-32"	<b>89780 M</b>
Large	34"-36"	<b>89780 L</b>
X-Large	38"-40"	<b>89780 XL</b>
2X-Large	42"-44"	<b>89780 XXL</b>



**8" Abdominal Binder**

- Elastic woven, shaped back

Size	Hip Circumference	Product No.
Small	24"-30"	<b>89760 S</b>
Medium	31"-36"	<b>89760 M</b>
Large	37"-42"	<b>89760 L</b>
X-Large	43"-48"	<b>89760 XL</b>
2X-Large	49"-54"	<b>89760 XXL</b>
3X-Large	55"-60"	<b>89760 XXXL</b>





**10" Abdominal Binder**

- Elastic woven, shaped back

Size	Hip Circumference	Product No.
Small	24"-30"	<b>89320 S</b>
Medium	31"-36"	<b>89320 M</b>
Large	37"-42"	<b>89320 L</b>
X-Large	43"-48"	<b>89320 XL</b>
2X-Large	49"-54"	<b>89320 XXL</b>
3X-Large	55"-60"	<b>89320 XXXL</b>
4X-Large	60"-65"	<b>89320 XXXXL</b>
5X-Large	66"-71"	<b>89320 XXXXXL</b>
6X-Large	72"-77"	<b>89320 XXXXXXL</b>



Soft and  
Semi-Rigid

Abdominal Binders (continued)						
DeRoyal	<b>Universal Abdominal Binder</b>					
	<ul style="list-style-type: none"> <li>• Latex free, hook and loop closure</li> <li>• 3 panel: 9", solid panel - 10", 4 panel - 12"</li> <li>• Measure circumference of male waist or female hips</li> </ul>					
			<b>Product No.</b>			
	<b>Size</b>	<b>Waist Circumference</b>	<b>3 Panel</b>	<b>Solid Panel</b>	<b>4 Panel</b>	
	Universal	27"-48"	13660000	13640000	13650000	
	X-Long	up to 54"	—	13600000	—	
	2X-Long	up to 70"	—	13590000	13630000	
	<b>Sized Abdominal Binders</b>					
	<ul style="list-style-type: none"> <li>• Latex free, hook and loop closure</li> <li>• Measure circumference of male waist or female hips</li> </ul>					
			<b>Product No.</b>			
<b>Size</b>	<b>Waist Circumference</b>	<b>3 Panel (9")</b>	<b>4 Panel (12")</b>			
Small/Medium	30"-45"	13661056	13651056			
Medium/Large	46"-62"	13662067	13652067			
Large	63"-74"	13663008	13653008			
X-Large	75"-84"	13664009	13654009			
2X-Large	85"-94"	13665010	13655010			
ProCare (DJO)	<b>Abdominal Binder</b>					
	<ul style="list-style-type: none"> <li>• Latex free, elastic binder with four-sewn in plastic stays</li> </ul>					
			<b>Product No.</b>			
	<b>Size</b>	<b>Waist Measurement</b>	<b>10"</b>	<b>12"</b>		
	Small	24"-30"	79-89043	79-89323		
	Medium	30"-36"	79-89045	79-89325		
	Large	36"-42"	79-89047	79-89327		
	X-Large	42"-48"	79-89048	79-89328		
	2X-Large	48"-54"	79-89049	79-89329		
	ProCare (DJO)	<b>Premium Panel Elastic Binder</b>				
<ul style="list-style-type: none"> <li>• Universal style, flannel lined panel elastic support with contact closure</li> <li>• Multi-panel design helps prevent panel rolling</li> </ul>						
			<b>Product No.</b>			
<b>Size</b>		<b>Waist Measurement</b>	<b>9"</b>	<b>12"</b>	<b>15"</b>	
			<b>3 Panel</b>	<b>4 Panel</b>	<b>5 Panel</b>	
Universal		30"-45"	79-89070	79-89090	—	
Universal		45"-62"	79-89071	79-89091	—	
X-Large		62"-74"	79-89210	79-89220	79-92149	
2X-Large	72"-84"	79-89270	79-89280	—		
3X-Large	82"-100"	79-89250	79-89260	—		
US. Orthotics	<b>Model 90-M101-U 10" Thoracic Binder</b>					
	<ul style="list-style-type: none"> <li>• Flexibloe stays to prevent rollover</li> </ul>					
	<b>Size</b>	<b>Waist Measurement</b>	<b>Product No.</b>			
Universal	26"-49"	90-M101-UNIV				



**Elastic Rib Belts**

- For use with fractures and strains to the rib cage

Medline	<b>6" Universal Rib Belt</b>				
	• Latex free				
	<b>Size</b>	<b>Rib Measurement</b>	<b>Product No.</b>		
		<b>Men's</b>	<b>Women's</b>		
	Universal	28"-50"	<b>ORT20100M</b>	<b>ORT20100F</b>	
Ossur	<b>Universal Elastic Rib Belt</b>				
	• Flannel lined				
	<b>Size</b>	<b>Rib Measurement</b>	<b>Product No.</b>		
		<b>Men's</b>	<b>Women's</b>		
	Universal	—	<b>209150</b>	<b>209160</b>	
ProCare (DJO)	<b>Universal Deluxe Rib Belt</b>				
	• 6" two-panel elastic belt with flannel lining				
	• Latex free				
	<b>Size</b>	<b>Rib Measurement</b>	<b>Product No.</b>		
			<b>Men's</b>	<b>Women's</b>	
	Universal	28"-50"	<b>79-89150</b>	<b>79-89160</b>	
	Universal - 6 pack	28"-50	<b>79-99040</b>	<b>79-99030</b>	
	X-Large - 6 pack	50"-65"	<b>79-89151</b>	—	
US Orthotics	<b>Model 90-M81-U 8" Elastic Belt</b>				
	• Flexible stays				
	• Color: White				
	<b>Size</b>	<b>Rib Measurement</b>	<b>Product No.</b>		
	—	26"-49"	<b>90-M81-UNIV</b>		

**SI Belts**

- Provides joint support to the SI joint

AllMed	<b>Saunders SI Belt and Stabilization Pad</b>				
	• Non-slip design				
	• Semi-elastic belt				
	<b>Size</b>	<b>Hip Measurement</b>	<b>Product No.</b>		
	Small	fits 26"-32"	<b>51833</b>		
	Medium	fits 32"-42"	<b>51834</b>		
	Large	fits 42"-52"	<b>51835</b>		
	<b>Stabilization Pad (one size)</b>			<b>51836</b>	
Breg	<b>BOA SI Belt</b>				
	• Lacer Compression System				
	• Breathable Airmesh liner				
	• Latex free				
	<b>Size</b>	<b>Hip Measurement</b>	<b>Product No.</b>		
	Small	25"-35"	<b>60072</b>		
	Medium	35"-45"	<b>60073</b>		
	Large	45"-55"	<b>60074</b>		

SI Belts (continued)

<b>Donjoy (DJO)</b>	<b>SI Belt</b>			
	<ul style="list-style-type: none"> <li>• Measured of the hip measurement 1" above</li> <li>• Color: Black</li> </ul>			
	<b>Size</b>	<b>Hip Measurement</b>	<b>Product No.</b>	
	Small/Medium	25"-35"	<b>11-1571-3</b>	
Large/X-Large	35"-55"	<b>11-1571-4</b>		

**ProCare (DJO) - 8" ComfortFORM™ Moldable Insert**

- Can be heated with a heat gun or at 160° in a hot water pan, or hydrocollator and then formed against patient's back for exact contour and improved support
- To be used with a compatible support to provide rigid support to the lower back
- Universal 8" insert



Description	Product No.
Individual Insert	<b>79-89120</b>
10/pack	<b>79-89121</b>

**Scott Specialties - P.R. Heat Moldable Inserts**

- Contains exclusive low-temp, lightweight plastic
- Molds directly to the skin for a perfect mold and maximum support
- Bonded foam insulation insures patient comfort during molding

Description	Product No.
Shaped Insert for 7 <sup>3</sup> / <sub>8</sub> " belts	<b>107-1</b>
Straight Insert for 8" belts	<b>0102</b>
Shaped Insert for 12" belts	<b>0107</b>
Straight Insert for 12" belts	<b>0108</b>



**Knit-Rite - Torso Interface®**

- Improved skin protection and patient comfort
- CoolMax®/Lycra® is a moisture wicking fiber
- X-STATIC/Lycra® and CoolMax®/Lycra® are antimicrobial to help eliminate odor in the garment
- Crew neck and V-neck styles are designed with ribbed edgings at neck, arm holes and waist band
- Torso-Interface provides more cushioning, moisture-wicking properties to keep skin dry, protected, and comfortable

Width X Length	Fits Circumference	Product No.
<b>Crewneck - 1-Ply - Polyester/X-STATIC/Lycra</b>		
6" x 14"	14"-18"	<b>1BX1BSSM</b>
8" x 16"	18"-24"	<b>1BX1BSMD</b>
10" x 20"	22"-30"	<b>1BX1BSLG</b>
10" x 24"	22"-30"	<b>1BX1BSLL</b>
12" x 24"	26"-38"	<b>1BX1BSXL</b>
14" x 24"	30"-48"	<b>1BX1BSKS</b>
14" x 28"	30"-48"	<b>1BX1BSKX</b>
<b>Crewneck - 1-Ply - CoolMax/Lycra</b>		
4" x 12"	10"-12"	<b>1BP1BSXS</b>
6" x 14"	14"-18"	<b>1BP1BSSM</b>
8" x 16"	18"-24"	<b>1BP1BSMD</b>
8" x 20"	18"-24"	<b>1BP1BSML</b>
10" x 20"	22"-30"	<b>1BP1BSLG</b>
10" x 24"	22"-30"	<b>1BP1BSLL</b>
12" x 24"	26"-38"	<b>1BP1BSXL</b>
14" x 24"	30"-48"	<b>1BP1BSKS</b>
14" x 28"	30"-48"	<b>1BP1BSKX</b>
<b>Crew Neck with Sleeves - 1-Ply - CoolMax/Lycra</b>		
6" x 16"	18"-24"	<b>1BP1SSSM</b>
8" x 18"	22"-30"	<b>1BP1SSMD</b>
8" x 20"	18"-24"	<b>1BP1SSML</b>
10" x 20"	22"-30"	<b>1BP1SSLG</b>
10" x 20"	22"-30"	<b>1BP1SLL</b>
12" x 24"	26"-38"	<b>1BP1SSXL</b>
12" x 24"	26"-38"	<b>1BP1SSXX</b>
<b>Crew Neck - Cotton/Lycra</b>		
4" x 12"	10"-12"	<b>1BC1BSXS</b>
6" x 14"	14"-18"	<b>1BC1BSSM</b>
8" x 16"	18"-24"	<b>1BC1BSMD</b>
10" x 20"	22"-30"	<b>1BC1BSLG</b>
10" x 24"	22"-30"	<b>1BC1NSLL</b>
12" x 24"	26"-38"	<b>1BC1BSXL</b>



*Crew Neck*



*Crew Neck with Sleeves*

Width x Length	Fits Circumference	Product No.
<b>Crew-Neck - Axilla Flaps - CoolMax/Lycra</b>		
6" x 14"	14"-18"	<b>1BP1DDSM</b>
8" x 16"	18"-24"	<b>1BP1DDMD</b>
8" x 22"	18"-24"	<b>1BP1DDDL</b>
10" x 20"	22"-30"	<b>1BP1DDLG</b>
10" x 24"	22"-30"	<b>1BP1DDL</b>
12" x 24"	26"-38"	<b>1BP1DDXL</b>
<b>V-Neck - Axilla Flaps - CoolMax/Lycra</b>		
6" x 16"	14"-18"	<b>1BP1BDSM</b>
8" x 18"	18"-24"	<b>1BP1BDMD</b>
8" x 20"	18"-24"	<b>1BP1BDML</b>
10" x 20"	22"-30"	<b>1BP1BDLG</b>
10" x 24"	22"-30"	<b>1BP1BDLL</b>
12" x 24"	26"-38"	<b>1BP1BDXL</b>



V-Neck

<u>Left Flap</u>	<u>Double Flap</u>			
Width x Length	Width x Length	Fits Circum.	Left Flap	Double Axilla Flaps
<b>V-Neck with X-STATIC - The Silver Fiber - 1-Ply - Polyester/X-STATIC/Lycra</b>				
6" x 14"	6" x 16"	14"-18"	<b>1BX1BLSM</b>	<b>1BX1BDSM</b>
8" x 16"	8" x 18"	18"-24"	<b>1BX1BLMD</b>	<b>1BX1BDMD</b>
10" x 20"	10" x 20"	22"-30"	<b>1BX1BLLG</b>	<b>1BX1BDLG</b>
10" x 24"	10" x 24"	22"-30"	<b>1BX1BLLL</b>	<b>1BX1BDLL</b>
12"	12"	26"-38"	<b>1BX1BLXL</b>	<b>1BX1BDXL</b>

Width x Length	Fits Circumference	Product No.
<b>Turtleneck with Sleeves - X-STATIC</b>		
4" x 12"	10"-12"	<b>1BX1BTXS</b>
6" x 14"	14"-18"	<b>1BX1BTSM</b>
8" x 16"	18"-24"	<b>1BX1BTMD</b>
<b>Without Straps or Caps - 1-Ply CoolMax/Lycra</b>		
6" x 14"	14"-18"	<b>1BP1B614</b>
8" x 16"	18"-24"	<b>1BP1B816</b>
8" x 20"	18"-24"	<b>1BP1B820</b>
10" x 20"	22"-30"	<b>1BP11018</b>
10" x 20"	22"-30"	<b>1BP110LL</b>
12" x 20"	26"-38"	<b>1BP112XL</b>



without straps or caps

**Trulife - Pectus Caritanum Orthosis**

- Increased anterior/posterior directed corrective compression forces
- Bendable metal components
- One size fits most

**Indications:** Abnormal chest shape; Protrusion of both the sternum (breast bone) and the cartilage portion of the ribs; Bowed chest (Pigeon chest)

Product No.

**PECTUS**

