

**Tools**

- Shoe Stretchers . . . . . 562
- Brannock Measuring Device . . . . . 562
- Mixing Bowls . . . . . 562
- Aluminum Cast Mandrels . . . . . 562
- Laminating Fixtures . . . . . 563
- Vises and Yates Clamps . . . . . 563-564
- Measuring Devices . . . . . 564-567
- Hex Sets and Balldrivers . . . . . 567-569
- Screw and Drill Gages . . . . . 569
- Cutting Nippers . . . . . 570
- Plastering Tools . . . . . 571
- Shears and Scissors . . . . . 571-572
- Blades, Knives and Surforms . . . . . 572-575
- Rivets, Punch Sets and Eyelets . . . . . 576-579
- Reamers . . . . . 579
- Needle Kit . . . . . 579
- Deburring Tool . . . . . 579
- Rout-A-Burr . . . . . 579
- Precision Oiler . . . . . 580
- Countersinks . . . . . 580
- Adjustable Bits . . . . . 580
- Ball Set Tool . . . . . 580
- Micro Torches and Heat Guns . . . . . 580-582
- Cast Spreaders and Cutters . . . . . 583-584
- Alignment Fixtures . . . . . 584
- Benders and Contouring Iron . . . . . 584-585

**Equipment**

- Carvers, Cutters and Routers . . . . . 585-588
- Sanding Accessories . . . . . 589-591, 601-603
- Sewing and Patching Machines . . . . . 592
- Drill Press . . . . . 593
- Band Saws . . . . . 594-595
- Dust Collectors . . . . . 596-597
- Sanders and Arbors . . . . . 597, 601
- Finishing Machines . . . . . 598-600
- Sanding Accessories . . . . . 601-603
- Air Purification . . . . . 604
- Cutters . . . . . 605
- Vacuum Systems . . . . . 605-607
- Spray Booths and Heat Activators . . . . . 607
- Ovens . . . . . 608-609
- Lab Equipment and Safety . . . . . 609-612
- Exam Tables and Accessories . . . . . 612-614
- Scales . . . . . 614
- Parallel Bars . . . . . 614-615
- Mirrors . . . . . 615
- Exam Stools . . . . . 616



**Ball and Ring Stretcher with Clamp**

Product No. **9092**

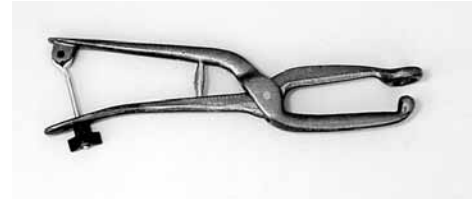

**Liquid Shoe Stretcher**

Product No. **8080**

**“Brannock” Measuring Device**

- Measures length and width of foot for shoe size selection

Description	Product No.
Men’s Brannock	<b>1131M</b>
Women’s Brannock	<b>1131W</b>
Children’s Brannock	<b>1131C</b>

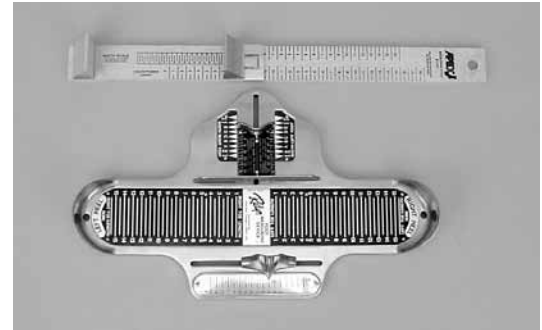

**Rubber Mixing Bowls**

- Set of four

Description	Product No.
Rubber Mixing Bowls Kit	<b>SP1200</b>
<b>Includes:</b>	
4 oz	<b>SP1210</b>
1 pint	<b>SP1220</b>
1½ quart	<b>SP1230</b>
1 gallon	<b>SP1240</b>



**Silicone Mixing Bowl**

- Ideal for big or small jobs
- 12 oz

Product No. **CD311**



CD311

**Aluminum Cast Mandrel**

- Use in fabrication procedures when a flat proximal surface and no protruding pipe or a hollow break out model is desired
- Replaceable pipe secured in place with Loctite

Length	Width	Product No.
15”	2 <sup>3</sup> / <sub>8</sub> ”	<b>259050</b>
10”	2 <sup>3</sup> / <sub>8</sub> ”	<b>259053</b>
7½”	2 <sup>3</sup> / <sub>8</sub> ”	<b>259060</b>
7½”	1 <sup>3</sup> / <sub>4</sub> ”	<b>259056</b>



### Laminating Fixture

- May be positioned to hold cast at any angle or degree of rotation
- Large PVA tie-off ring and hose attachments for inside and outside vacuum lines make laminating easier and faster

Description	Product No.
Complete Laminating Fixture	51454
Vacuum Device Assembly Only	51459
Vacuum Laminating Assembly Only	51455

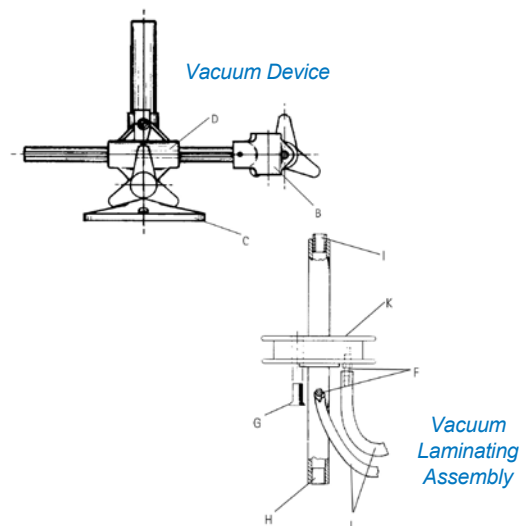

### Prosthetic Vise

Product No. **T046000000**

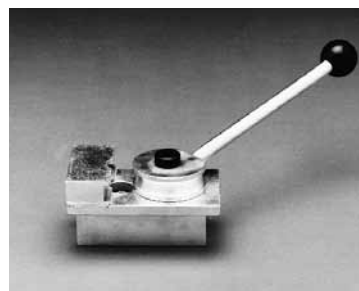

### Pipe Holder Fixture

Description	Product No.
Pipe Holder Fixture, Vice Mount	220129
Bench Mounted Pipe Holding Fixture, 8" high	220131
Laminating Stand with Pipe Holding Fixture	220133



### MICA Vise System

- Accepts standard 1/2" cast pipe used for casts and all MICA Vise tools
- Available with durable plated finish
- 360° accessibility

Product No. **2001000000**

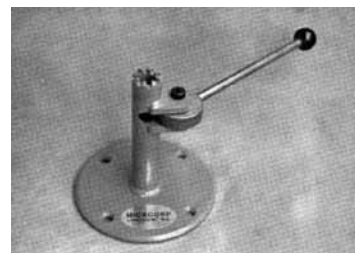

### Original Limb Makers Vise

Description	Product No.
Limb Makers Vise	220178
Replacement Pad	220301

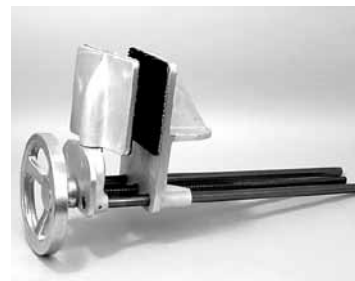

Tools

**Yates Clamp**

Description	Product No.
Flat Spring with 2 mounting holes 2 <sup>1</sup> / <sub>8</sub> "	<b>S-04</b>
Small 3 <sup>1</sup> / <sub>4</sub> "	<b>W-01</b>
Medium 3 <sup>3</sup> / <sub>4</sub> "	<b>W-02</b>
Large 4 <sup>3</sup> / <sub>4</sub> "	<b>W-03</b>



**AP Gauge**

- For AK sockets and Ischial orthosis brims
- Measures in inches or metrics

Product No. **220137**

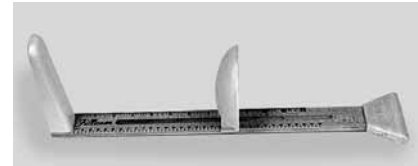

**Universal AP/ML Gauge (17")**

Product No. **220336**

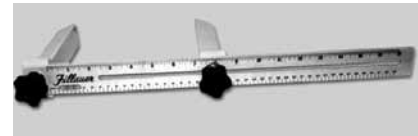

**BK Stump Length Gauge (17")**

Product No. **220145**

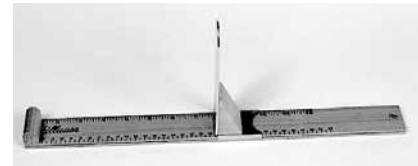

**Original AP-ML Gauge (22") (not pictured)**

Product No. **220335**

**BK Measuring Caliper**

Product No. **T095000000**

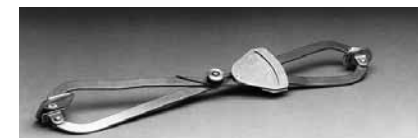

**Sanders Goniometer**

- A combination of a level and an adjustable protractor
- Useful tool for obtaining measurements that are relative to a horizontal plane

Product No. **51848**



**Goniometer**

Product No. **40049**

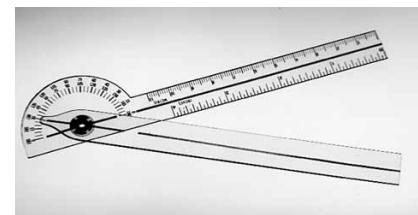

**Large International Standard Goniometer  
(not pictured)**

- Has three rows of numbers
- Outer row measures 0° to 90°, middle 0° to 180°, inner 0° to 360°, all in 1° increments
- Transparent, high-impact vinyl, 12<sup>1</sup>/<sub>2</sub>" length

Product No. **5054**

**Measuring Tape**

- Inch/metric, retractable plastic-coated cloth
- 60"

Product No. **DP485**



**Build Ups**

- 1/8" to 1" sections, stationary or mobile evaluation
- Strapped to foot with special hook and loop straps provided
- Can be used in combination of heights, instructions included

Size	Product No.
Adult	<b>B500</b>
Child	<b>B705</b>



Tools

**Tracing Paper Guide**

- Without lines

Product No. **154001**

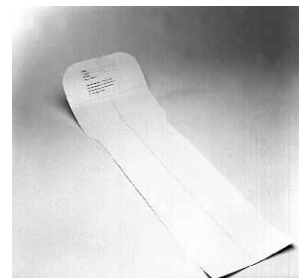

**Digital Scale**

- 13 lb capacity
- Scale dimension: 6<sup>2</sup>/<sub>5</sub>" x 7<sup>2</sup>/<sub>5</sub>" x 1<sup>3</sup>/<sub>5</sub>"

Product No. **SP9035**



**Precision Pencil Compass No. 842**

- Made of long lasting die cast, rust resistant metal
- Spring tension adjustment for marking up to 8" diameters
- Scribe guide for edge marking; Use with pencil or ballpoint pen

Product No. **24126 9**



**No. 17 Steel Protractor - Square Head**

- Used for setting bevels, measuring and transferring angles
- Made of ground stainless steel for optimum accuracy
- Permanently etched graduations from 0° to 180°
- 3<sup>3</sup>/<sub>8</sub>" x 2" head
- 6" adjustable protractor arm locks into desired position with knurled thumb nut



Product No. **22018 9**

**Utility Combination Square No. 811**

- Economy version of the carpenter's combination square is perfect for the do-it-yourselfer and home mechanic
- The 12" x 1" steel blade is graduated in 8ths, 16ths, and 32nds
- Heavy zinc cast head with level and scribe
- Front Grads: 8ths, 16ths
- Back Grads: 16ths, 32nds

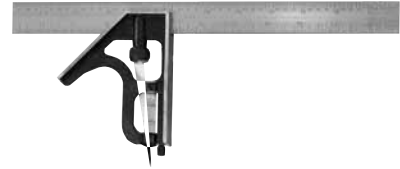

Product No. **24030 9**

**KD Beam Torque Wrench**

- 0-66 Nm <sup>3</sup>/<sub>8</sub>" drive



2956

Product No. **2956**

**Micrometer Torque Wrench**

- <sup>3</sup>/<sub>8</sub>" drive
- 2-29 Nm



85051

Product No. **85051**

**Plastic, Direct Reading Inch Dial Caliper No. 142**

- Measuring Capacity: 0"-6"
- Contrasting color coded dial is graduated in .01 and 64ths with inch and mm on bar scale
- Measures 4 ways: inside, outside, depth and step readings
- Freewheeling friction roller for repetitive and accurate readings
- Fractional conversion table on back



Product No. **44145 4**

**Outside Calipers No. 452**

- Forged steel



452

Description	Size	Product No.
452-8	8"	<b>31621 9</b>
452-10	10"	<b>31607 3</b>
452-12	12"	<b>31610 3</b>

### Outside Caliper No. 112

- Fully polished

Size	Max. Opening	Weight each	Product No.
6"	11"	2 oz	57062
8"	14 <sup>1</sup> / <sub>4</sub> "	3 oz	57064
10"	28 <sup>1</sup> / <sub>4</sub> "	5 oz	57066



112

### Inside Calipers No. 454

- Forged steel

Description	Size	Product No.
454-8	8"	31641 7
454-10	10"	31624 0
454-12	12"	31627 1



454

### Plastic Fold-Up Hex Key Sets

Description	Drill Sizes	Product No.
A. Small Inch (plastic handle)	<sup>5</sup> / <sub>64</sub> , <sup>3</sup> / <sub>32</sub> , <sup>7</sup> / <sub>64</sub> , <sup>1</sup> / <sub>8</sub> , <sup>9</sup> / <sub>64</sub> , <sup>5</sup> / <sub>32</sub> , <sup>3</sup> / <sub>16</sub> , <sup>7</sup> / <sub>32</sub> , <sup>1</sup> / <sub>4</sub>	12589
B. Small Metric (plastic handle)	2 mm, 2 <sup>1</sup> / <sub>2</sub> mm, 3 mm, 4 mm, 5 mm, 6 mm, 8 mm	12587
C. Fold-up Hex Key (metal Handle)	1 <sup>1</sup> / <sub>2</sub> mm, 2 mm, 2 <sup>1</sup> / <sub>2</sub> mm, 3 mm, 4 mm, 5 mm, 6 mm	5724A75
D. Fold-up Hex Key (metal handle)	.050, <sup>1</sup> / <sub>16</sub> , <sup>5</sup> / <sub>64</sub> , <sup>3</sup> / <sub>32</sub> , <sup>7</sup> / <sub>64</sub> , <sup>1</sup> / <sub>8</sub> , <sup>9</sup> / <sub>64</sub> , <sup>5</sup> / <sub>32</sub> , <sup>3</sup> / <sub>16</sub>	7162A13

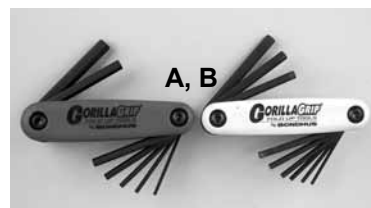

A, B

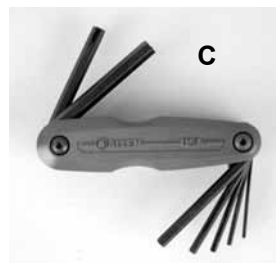

C

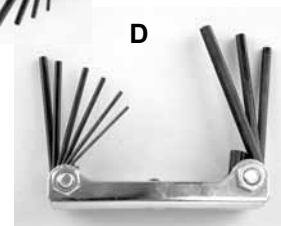

D

### Chamfered L-Shaped Hex Sets

- The Bondhus chamfer eliminates cut-off burr problems
- The clearance between the screw and the key is usually less than .001" (.025 mm) per side
- Wrenches come in Bondhus™ case

Description	Sizes	Product No.
9 piece Metric Set	1 <sup>1</sup> / <sub>2</sub> -10 mm	12199



12199

Tools

**Balldriver® L-Wrenches**

- Sets are ideal where a variety of tool sizes are required
- Sets are packaged in the patented Bondhex™ key case
- Wrenches slip easily into individually marked slots and twist to lock securely in place

Description	Drill Sizes	Product No.
13 pc Inch Set	.050, 1/16, 5/64, 3/32, 7/64, 1/8, 9/64, 5/32, 3/16, 7/32, 1/4, 5/16, 3/8	<b>10937</b>
6 pc Metric Set	1 1/2 mm, 2 mm, 2 1/2 mm, 3 mm, 4 mm, 5 mm	<b>10946</b>
9 pc Metric Set	1 1/2 mm, 2 mm, 2 1/2 mm, 3 mm, 4 mm, 5 mm, 6 mm, 8 mm, 10 mm	<b>10999</b>



10937

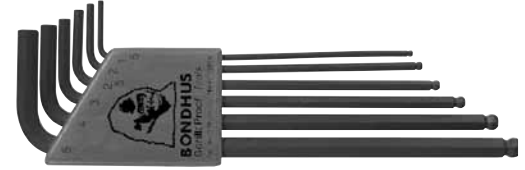

10946



10999

**Hex Driver Sets**

Description	Drill Sizes	Product No.
13 pc Inch Set	.050, 1/16, 5/64, 3/32, 7/64, 1/8, 9/64, 5/32, 3/16, 7/32, 1/4, 5/16, 3/8, ballpoint	<b>10637</b>
9 pc Metric Set	1 1/2 mm, 2 mm, 2 1/2 mm, 3 mm, 4 mm, 5 mm, 6 mm, 8 mm, 10 mm	<b>10699</b>



10637



10699

**Long T-Handle Balldriver Hex Sets**

Description	Drill Sizes	Product No.
10 pc Inch Set (pictured)	3/32, 7/64, 1/8, 9/64, 5/32, 3/16, 7/32, 1/4, 5/16, 3/8	<b>13138</b>
8 pc Metric Set	2 mm, 2 1/2 mm, 3 mm, 4 mm, 5 mm, 6 mm, 8 mm, 10 mm	<b>13187</b>



13138



**Individual Hex Drivers**

Description	Product No.
2 1/2 mm T-Handle	<b>13254</b>
4 mm T-Handle Hex with Ballpoint	<b>13160</b>
4 mm Ball Driver Hex Tool	<b>10660</b>
4 mm T-Handle	<b>51293</b>
4 mm T-Handle	<b>WIHA33406</b>
4 mm L-Wrench Hex Key with Ballpoint	<b>10960</b>



**General Tools Manufacturing Co. - Quick Check Screw Gage No. 714**

- Quick way to identify machine screws, bolts, wood screws, standard size rivets and common cotter pin sizes up to 5/16" (8 mm)
- 3" scale to check screw lengths
- Checker gives required drill size for corresponding tap size and proper drill size for like hole
- Threaded holes indicate threads per inch while unthreaded indicate size by number and fractions of an inch

Product No. **35018 3**



**Drill Gages**

- General's drill gages are used to quickly and conveniently identify drill bit sizes
- Made of heat treated heavy gage steel machined and ground to close tolerances
- Hole sizes and decimal equivalents are permanently etched on the face

Description	Drill Sizes	Product No.
No. 13	61-80	<b>22006 6</b>
No. 14	1/16" to 1/2"	<b>22009 7</b>
No. 15	1-60	<b>22012 7</b>
No. 24	1/16" to 1/2" x 64ths	<b>22011 0</b>



No. 13



No. 14

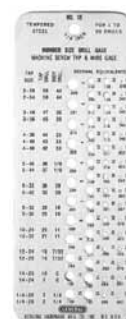

No. 15



No. 24



**C.S. Osborne & Co. - Osborne No. 94  
End Cutting Nipper**

- Made of drop forged steel, solid jaws
- Black finished handle, polished jaws
- Flush cut
- Length: 7"; Weight: 7 oz

Product No. **54122**



No. 94

**Osborne No. 91 Diagonal Cutting Nipper**

- Ideal for cutting wire, nails, etc.
- Polished head, black handle, finest quality
- Length: 8"; Weight: 8 oz

Product No. **54082**



No. 91

**Osborne No. 93 Shoemaker's Pincer**

- Shoemaker's heel pincers or carpenter's pincers
- Forged steel and polished jaws
- Cutting edge outside flush cut, inside bevel cut
- Length: 6 1/2"; Weight each: 13 oz

Product No. **54112**



No. 93

**8 1/2" End Cutting Nipper**

Product No. **21326**



**Pliers**

- Long Nose
- Packaged individually

Product No. **21345A**

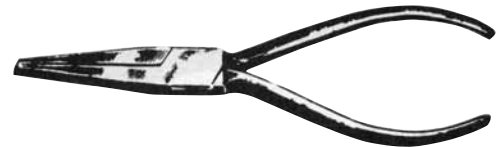

**Lasting Pincer Osborne No. 233**

- Drop Forged
- Width of jaw: 5/16"
- Overall length: 8 1/2"
- Weight: 13 oz

Product No. **54032**



**Scarpas Knife**

Description	Product No.
Large for above knee	<b>220460</b>
Small for below knee (not pictured)	<b>220461</b>

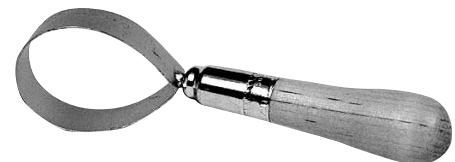

**Plaster Scoop**

- An easy way to make modifications to plaster models

Product No. **CD304**

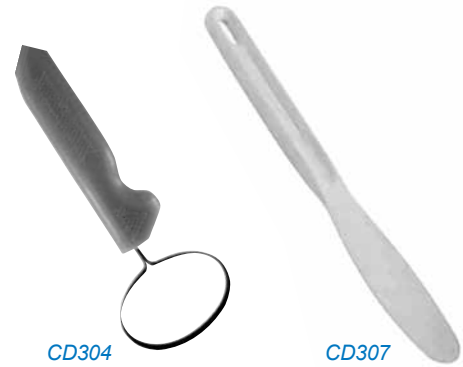

CD304

CD307

**Plaster Spreader**

- Use for build-ups during modifications
- Easy to clean

Product No. **CD307**

**Shears**

- Drop forged with polished blade

Description	Product No.
A. 8" Serrated Belt and Leather Shears	<b>8BLT</b>
B. 7" Shears	<b>60552</b>
C. 8" Shears	<b>60562</b>
C. 9" Shears (not pictured)	<b>29-S</b>
D. 10" Shears	<b>60512</b>
D. 10" Left Hand Shears (not pictured)	<b>20LH</b>
E. 12" Shears	<b>22</b>
F. 10" Heavy Duty Shears	<b>W20-W</b>
G. 12" Heavy Duty Shears	<b>W22-W</b>

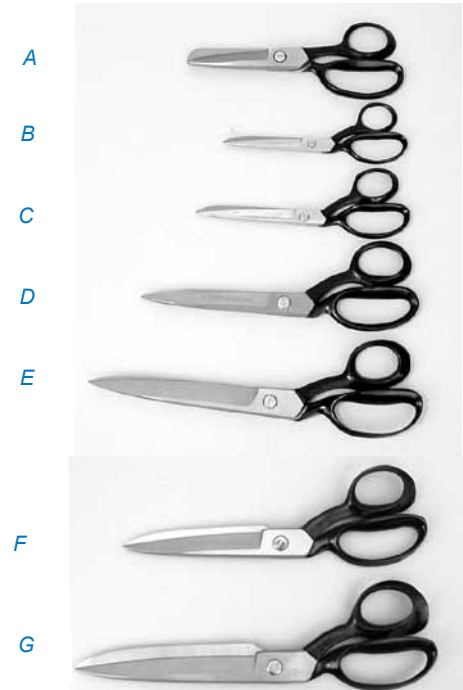

A

B

C

D

E

F

G

**10" HD Serrated Shears (not pictured)**

Product No. **50/7323-010**

**Alpha Finny 3XL Heavy Duty Tailor Shears**

- 5 mm thick dura-steel blade for extended lifetime
- Ergonomic perfect grip cushioned handle

Description	Product No.
H. 10" 3XL HD Shears	<b>74525</b>
H. 12" 3XL HD Shears	<b>74530</b>



H

Tools

**Bandage Scissors**

Description	Product No.
I. Pocket size with clip	<b>Bandage Scissors</b>
J. 7 <sup>1</sup> / <sub>4</sub> " Bandage Scissors	<b>2609WPS7</b>
K. "Super Mite" 125mm Angled Serrated Cutter	<b>50/1550-125</b>
L. Lister 180mm Bandage Scissors	<b>52/3550-180</b>
M. Plaster Scissors	<b>52/5359-220</b>
N. "Excentric" 190mm Plaster Scissors	<b>52/5362-190</b>



**C.S. Osborne & Co. - Osborne No. 76 Square Point Knife**

- The finest quality knife with round plantation tropical hardwood handle, brass ferrule
- Widely used in many industries
- Steel blade
- Length of Blade: 3<sup>3</sup>/<sub>4</sub>"
- Width of Blade: <sup>3</sup>/<sub>4</sub>"
- Weight each: 2 oz

Product No. **60042**



60042

**Osborne No. 76<sup>1</sup>/<sub>2</sub> Square Point Knife**

- The white hardwood handle is somewhat shorter and heavier than the Osborne No. 76
- Steel blade
- Length of Blade: 3<sup>7</sup>/<sub>8</sub>"
- Width of Blade: <sup>5</sup>/<sub>8</sub>"
- Weight each: 2 oz

Product No. **60046**



60046

**Osborne No. 78 Broad Point Knife**

- Same as Osborne No. 76<sup>1</sup>/<sub>2</sub>, but furnished with steel safety guard
- Length of Blade: 5"
- Width of Blade: 1<sup>1</sup>/<sub>8</sub>"
- Weight each: 2 oz

Product No. **60054**



60054

**Osborne No. 479 Bevel Point Knife**

- Used for skiving and edge trimming on leather and similar materials
- Plated ferrule
- Lacquered hardwood handle
- Length of Blade: 3"
- Weight each: 2 oz

Product No. **60112**



60012

**Osborne No. 79 1/2 Sharp Point Knife**

- Used for skiving and edge trimming on leather and similar materials
- Plated ferrule
- Lacquered hardwood handle
- Length of Blade: 3 3/4"
- Width of Blade: 3/4"
- Weight each: 2 oz

Product No. **60060**



**Round Point Knives**

Description	Product No.
No. 3 Shoe Knife (3 1/2" blade)	<b>3RDPT</b>
No. 4 Shoe Knife (4" blade)	<b>4RDPT</b>
No. 6 Skinning Knife (6" blade)	<b>6RDSK</b>
No. 7 Skinning Knife (7" blade)	<b>7RDSK</b>



**Taper Point Shoe Knife**

- 4" (10.2 cm) blade, 17 gauge

Product No. **4TAPT**



**Surform Files**

- For fast shaping of plaster cast
- Can also be used on wood and plastics

Description	Product No.
Round file, complete with handle	<b>ST21297</b>
Flat file, complete with handle	<b>ST21295</b>
Round blade only	<b>ST21291</b>
Flat blade only	<b>ST21293</b>
Half round blade only	<b>ST21299</b>



**Modification Handles**

- A Surform blade handle specifically for orthotic and prosthetic cast modification
- Fits 10" half round and flat blades

Description	Product No.
Blue Modification Handle	<b>CD309</b>
Pink Modification Handle	<b>CD309P</b>
<b>Blades for Modification Handles</b>	
Half Round Blades (10/pack)	<b>CD309H</b>
Flat Blades (10/pack)	<b>CD309F</b>



Tools

**Stanley Utility Knife**

- Bright aluminum finished heavy duty die cast handles provide blade storage
- Has handy hang hole
- Furnished with 3 each No. 11-921 blades and blade guard

Product No. **ST10209**

**Blade Dispenser**

- Contains 100 utility knife blades
- Will display dispenses blades one at a time for safety and convenience
- Holds blades: 11-921

Product No. **ST11921A**



**Hook Blade (not pictured)**

- Package of 5

Product No. **ST11961**

**Stanley Retractable Utility Knife (not pictured)**

- Multi-position blade slide
- Blade storage in handle
- Includes 3 blades

Product No. **10-099**

**Wheel Cutters**

Description	Product No.
Wheel Cutter, 1 <sup>3</sup> / <sub>16</sub> "	<b>ST800</b>
Replacement Blade, 10/pk	<b>C280</b>
Wheel Cutter, 1 <sup>3</sup> / <sub>4</sub> "	<b>ST810</b>



**Draw Knife**

- 1/8" overall x 10" blade

Product No. **DRAW KNIFE**



**Fillauer - Slimknife™**

Description	Product No.
Slimknife	<b>10-109A</b>
Replacement Blades, 2 <sup>1</sup> / <sub>8</sub> " (3-pack)	<b>11-113</b>

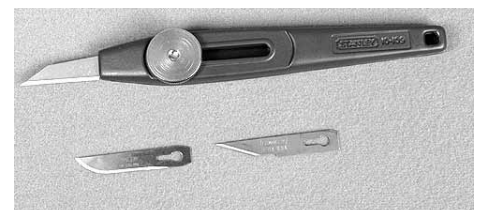

### Hobby Knife Blades

- 5 blades/pack

Number	Replacement for	Product No.
1920	1901	<b>43988 8</b>
1922	1902, 1903	<b>43992 5</b>
1923	1902, 1903	<b>43994 9</b>

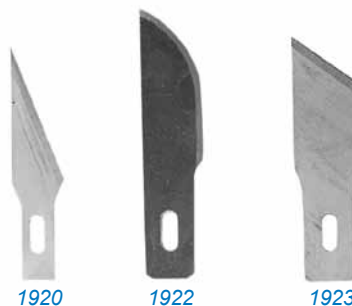

### Precision Hobby Knives

Number	Handle Construction	Knife Weight	Product No.
1901	Aluminum	Light duty	<b>43974 1</b>
1902	Aluminum	Medium duty	<b>43976 5</b>
1903	Aluminum	Heavy duty	<b>43978 9</b>



### Hacksaw Blade (not pictured)

- High speed bimetal blade
- 10" long x 1/2" wide x .025" thick
- 18 Tpi

Product No. **6927A11**

### Tweezer Sets Six Piece Tweezer Set No. C421

- Consists of six tweezers for home and industrial use
- One each of Nos. 401XX, 403, 412, 414, 415, 417
- In clear vinyl pouch

Product No. **42309 2**



### Hardwood Handle Scratch Awl No. 818

- Our finest quality scratch awl is also our best seller
- Alloy steel blade runs through the handle and is securely fastened to both the plated steel ferrule and the cap
- Hardwood fluted handle is contoured for comfortable grip
- Overall length is 6 1/2" with 3 1/2" blade

Product No. **24047 7**



### Osborne - No. 169 and 170 Rivet Setters

- Polished face, black finish, forged steel
- Hardened working end

Copper Rivet	Rivet Hole Diameter	Rivet Shank Diameter	Product No.
8	.191	.181	<b>67252</b>
10	.161	.151	<b>67256</b>
12	.141	.137	<b>67236</b>



Tools

**Rivet Tools**

Description	Product No.
Master Deluxe Rivet Set (9 piece)	<b>S151</b>
Master Rivet Set (6 piece)	<b>S150</b>
Long Rivet Bar w/Round Attachment	<b>2101000000</b>
Rivet Set	<b>2108000000</b>
27" Rivet Bar with Square Attachment	<b>22211</b>

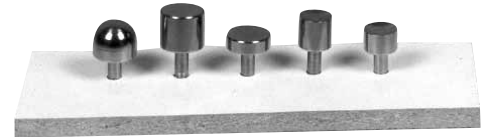

Rivet Set



Long Rivet Bar



27" Rivet Bar



**Ziegler Tools - Pilot and Back Spotfacers**

Description	Product No.
<b>Pilots (Shaft)</b>	
5/32"	<b>185-3</b>
3/16"	<b>185-4</b>
<b>Back Spotfacers</b>	
3/8" diameter	<b>190-3L</b>
1/2" diameter	<b>190-5K</b>

**C.S. Osborne & Co. - No. 155 Revolving Punch**

- Cutting tubes are turned from special carbon tool steel and threaded to allow easy replacement
- Tubes are individually hardened
- Reach distance from the cutting tube to the back of jaw is 1 1/2"
- Weight each: 14 oz

Size	Product No.
Revolving Punch, sizes 1, 2, 3, 4, 5, 6	<b>52010</b>
Revolving Punch, sizes 0, 1, 2, 3, 5, 7	<b>52012</b>
Extra Anvil	<b>52052</b>
Extra Handle Spring	<b>02070</b>
Extra Side Spring	<b>02072</b>
<b>Replacement Tubes (individual sizes)</b>	
Replacement Tube, size 00 (1/16")	2/pack <b>52022</b>
Replacement Tube, size 0 (5/64")	2/pack <b>52024</b>
Replacement Tube, size 1 (3/32")	2/pack <b>52026</b>
Replacement Tube, size 2 (7/64")	2/pack <b>52028</b>
Replacement Tube, size 3 (1/8")	2/pack <b>52030</b>
Replacement Tube, size 4 (5/32")	2/pack <b>52032</b>
Replacement Tube, size 5 (11/64")	2/pack <b>52034</b>
Replacement Tube, size 6 (3/16")	2/pack <b>52036</b>
Replacement Tube, size 7 (13/64")	2/pack <b>52038</b>
<b>Replacement Tubes (sets of 6)</b>	
Set of Replacement Tubes, sizes 0-7	<b>02044</b>
Set of Replacement Tubes, sizes 1-6	<b>02046</b>





### No. 149 Arch Punch

- Drop forged from special carbon steel
- Inside taper permits punchings to clear easily through the barrel
- The cutting edge is fully hardened all the way through and properly finished to provide long use, trouble-free punching

Diameter	Weigh		Product No.
	pounds	ounces	
3/4"	—	9	<b>01028</b>
1"	1	1	<b>01036</b>
1 1/2"	1	12	<b>01052</b>



### No. K-16 Arch Punch Set

- Set of seven arch punches of sixteenth sizes are incremented by 1/8" starting with 3/16"
- They are put up in a sturdy, easy to use canvas tool roll (as shown)
- Weight per set: 4 lbs
- 1 each of following sizes, Osborne No. 149 - Arch Punch
- 3/16", 5/16", 7/16", 9/16", 11/16", 13/16", 15/16"

Product No. **01181**



### No. K-245 Belt Punch Set

- Kit contains the most frequently used sizes
- Weight per set: 12 oz

Product No. **01520**

Sizes	Diameter
2	1/8"
4	5/32"
6	3/16"
9	1/4"
12	5/16"
14	3/8"



### No. 151 Bag or Oblong Punch

- Taper clearance
- Polished barrel, hardened and polished edge
- Used extensively by leather bag and strap manufacturers
- Weight: 7 oz; Length: 1"; Width: 5/32"

Product No. **01772**



### No. 603 Cutting Pad

- Made of a special formula resilient vinyl plastic
- Long wearing and can be used on both sides
- Cutting pads should be used on a solid base for best results
- Size: 10" x 10" x 1/2"; Weight: 2 lbs, 4 oz
- Other sizes quoted upon application

Product No. **67692**



Tools

**Shoe Systems Plus - N4 Hook and Eyelet Attaching Kit**

- Comes with everything needed to easily replace eyelets (3 sizes) and large skate hooks
- Optional dies available to attach snaps, rivets and grommets, even punch holes
- Kit includes machine, #51, #52, #54 eyelets dies and #GH10 hook die

Product No. **N4-ESK**



**N4 Hook and Eyelet Machine**

- Accessories sold separately

Product No. **N4**



1/2"	5/8"	#54	#52	#51	#50	#00	#0	#1
O80	O95	1054	1252	1351	1450	S00	S0	S1
#2	#3	Sm. Skate Hook	Lg. Skate Hook	Die #33	Die #34	Die #36	Leather punches	
							Sizing: 1/16"-1/2" (Individual sizing available)	
S2	S3	GH9	GH10	R33	R34	R36		

**General Tools Manufacturing Co. - Steel Automatic Center Punch No. 79**

- For making lighter markings than our heavy-duty punch No. 78
- All-steel 5" body with threaded, replaceable hardened steel point and shaft; Body diameter is 1/2"

Description	Product No.
Automatic Center Punch	<b>31072 9</b>
Replacement Point	<b>31078 1</b>



**Round Shank Punch**

- Points are ground to size for maximum strength and penetration
- Knurled body
- Stamped with size for quick identification

Number	Dia. at Top of Taper	Body Length	Diameter	Product No.
74AA	1/16"	3 1/8"	1/4"	<b>31020 0</b>
74B	3/32"	4"	5/16"	<b>31024 8</b>



### Drive Pin Punches

- Tool steel punches are uniformly heat treated and centerless ground to withstand the hardest use
- 4" long with knurled bodies
- Ends are ground square for accurate pin driving

Number	Punch Diameter	Overall Length	Length of Drive	Product No.
75A	1/16"	4"	3/4"	31034 7
75B	3/32"	4"	3/4"	31036 1
75C	1/8"	4"	3/4"	31038 5
75D	5/32"	4"	3/4"	31040 8
75E	3/16"	4"	1"	31042 2
75F	7/32"	4"	1"	31044 6
75G	1/4"	4"	1"	31046 0
75H	5/16"	4"	1"	31048 4



### Hand Reamer and Countersink No. 196

- Handy tool for countersinking or deburring small jobs
- Deburrs plastic, copper, iron pipe and sheet metal
- 5 1/8" overall length; Capacity: 3/4"

Product No. **23054 6**



### C.S. Osborne & Co. - Needle Kit Osborne No. K-3

- Curved Round Point needles
- Kit contains sizes 3", 4", 5", and 6"

Product No. **15014**



### Plastic Deburring Tool

Product No. **220321**



### General Tools Manufacturing Co. - Swivel Head Deburring Tool No. 482

- Economically priced, with the quality and performance of higher priced deburring tools
- Two interchangeable blades; 5" Aluminum handle

Product No. **42324 5**



### Rout-A-Burr

- Complete with blades (10/pack)

Description	Product No.
Rout-A-Burr	671-22600
B10 Blade	671-22110
B20 Blade	671-22120



Tools

**Precision Oiler No. 589**

- For the exact placement of oil or any other lubricant
- Smooth actuator allows for control and placement of lubricant
- Protective screw-on cover prevents leakage
- Overall length is 5<sup>5</sup>/<sub>8</sub>"

Product No. **58900 2**



**5 Flute Rose Pattern Countersinks**

- The rose pattern cutting flutes assure chatter free countersinking on steel, brass, aluminum, plastic, wood and other materials
- Made of high-speed steel with five flutes
- 82° point angle; 1/4" round shank

Size	Part No.	Product No.
1/2"	195-1/2	<b>23047 8</b>
5/8"	195-5/8	<b>23053 9</b>
3/4"	195-3/4	<b>23050 8</b>



**Adjustable Pilot Bits No. 34ST**

- Drill, countersink and counter bore precision screw holes in a single operation when doing fine carpentry and woodworking
- Hardened high-speed pilot bits give long life
- 1/4" hex shanks prevents slippage in electric drills and can be used in power screwdrivers
- Set of 4 pilot bits

Product No. **23041 6**



**Ball Set Tool**

- Quickly and securely sets a ball in the brace bar for retaining a drop ring

Diameter	Ball	Product No. Spring	Ball Set Tool
1/8"	<b>202002</b>	<b>202003</b>	<b>202001</b>
3/16"	<b>202005</b>	<b>202006</b>	<b>202004</b>

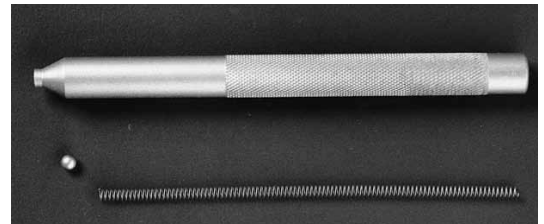

**Master Appliance - Ultra Touch® Butane Powered Micro Torch**

- This unique Micro torch is ideal for indoor/outdoor use
- Its wind-resistant flame and waterproof ignition puts out a razor sharp blue flame
- The unit runs off of a disposable butane gas lighter (included)
- It features a piezo electronic ignition with a safety lock
- Flame temperature goes up to 2500°F/1300°C
- Refill (Product No. RC-31)

Product No. **MT-11**



### Micro Torch Table Top

- Plastic tank

Product No. **MT-51**

### Micro Torch

- Includes Heat tip and 1" diameter shrink attachment

Product No. **MT-51H**



### Steinel America - Heat Gun HL 1910 (Variable Temperature)

- Variable temperature heat gun with electronic thermocouple control for flexible use and maximum reliability
- DuraTherm™ heating element ensures long life and even heat
- Continuously variable temperature from 120°F to 1100°F
- 1500 watt output
- 3-stage airflow switch: 3.6 (120° F) CFM; 10.6 and 17.6 CFM (variable temp.)

Product No. **34830**



### UltraHEAT SV800

- Dual temperature heat gun for general use
- Choice of two temperature settings: 600°F and 900°F
- 1300 watt output
- Quick heat-up and ultra quiet operation

Product No. **34100**



### UltraHEAT II SV803

- Variable temperature heat gun with 3 airflow settings for maximum user control
- Temperature knob adjusts temperature up to 1000° F
- 3 stage airflow switch: cool (140°), low air, high air
- Powerful 1400 watt output

Product No. **34103**

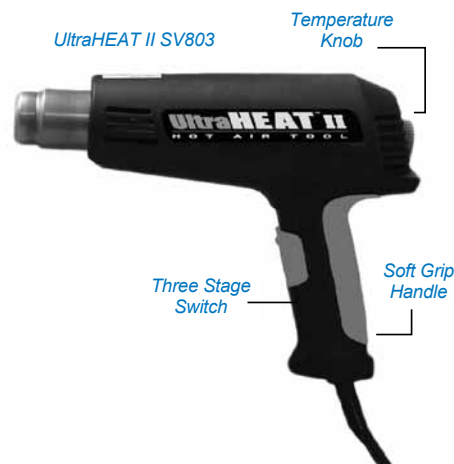

Tools

**Master Appliance - Master Heat Gun®**

- Temperatures up to 1000°F/538°C; 120 Volts
- Adjustable air intake controls output temperature and air volume
- Reinforced ceramic heating element. Rugged, die-cast aluminum housing with externally replaceable carbon brushes
- 3-wire oil resistant cord set

Description	Product No.	
	Heating Element	Heat Gun
300°-500° F (149°-260°C)	<b>HAS-041K</b>	<b>HG-301A</b>
500°-750° F (260°-400°C)	<b>HAS-011K</b>	<b>HG-501A</b>
750°-1000° F (400°-540°C)	<b>HAS-043K</b>	<b>HG-751B</b>



**Master-Mite® Heat Gun®**

- Heat gun with 650°F element & deflector
- 120 Volts/60 Hz/4.5 Amps; high impact plastic housing
- Brushless shaded pole continuous duty motor

Description	Product No.
Mastermite Heat Gun	<b>10008</b>
Pinpoint Attachment	<b>51309</b>



10008



51309

**Reduction Nozzles**

- Provides a precisely concentrated stream of hot air
- Used for welding or soldering
- Can be used as a base for specialized attachments
- Use with Steinel guns only

Description	Product No.
9 mm Reduction Nozzle	<b>07062</b>
14 mm Reduction Nozzle	<b>07071</b>
20 mm Reduction Nozzle	<b>07081</b>
20 mm Lap Welding Slit Nozzle	<b>07201</b>
40 mm Ankle Slit Nozzle	<b>07511</b>
Plastic Welding Nozzle with 6 mm Intake	<b>07091</b>



07071



07201



07511



07091

**Plastic Weld Rods (not pictured)**

- 16 rods per packet

Description	Product No.
HDPE	<b>07121</b>
LDPE	<b>07331</b>
PP Plastic	<b>07341</b>

**Hand Sealing Iron**

- Thermostatically controlled from 175° to 550° F

Description	Product No.
Heat Sealing Iron	<b>1983T2</b>
Teflon Cover	<b>226175</b>



### Standard Cast Spreader

- Solid stainless steel to resist corrosion and abrasive handling
- Larger hospital model (18<sup>1</sup>/<sub>2</sub>"") has superior leverage for two-handed operation while the small office model (9") has a spring-loaded handle for one-hand operation

Description	Product No.
Small (office)	21-0136
Standard	82

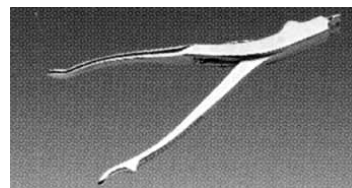

### BSN Medical - M-Pact Cast Cutter

- 115 volts
- Hexagonal blade drive
- Specially designed for rugged use; the perfect tool with power and endurance
- Balance of weight and power helps reduce user fatigue
- Hex drive provides six blade rotations extending blade life by 50% compared to similar competitive models

Product No. **0295-200**



### FEIN Multimaster Cast Cutter

- Variable speed oscillating tool
- Lightweight, ergonomically designed with SoftGrip Insert
- QuickIN rapid change system allows tool-free accessory changes

Description	Product No.
Multimaster Cast Cutter*	FMM 250QSTART
Multimaster saw blade 2 <sup>1</sup> / <sub>2</sub> " (5 ea./pk)	FMM 250C
Saw Blade <sup>3</sup> / <sub>4</sub> " HSS (5 ea./pk)	FMM 075
E-Cut Blade 1 <sup>1</sup> / <sub>8</sub> " (10 ea./pk)	FMM 112
E-Cut Blade 1 <sup>3</sup> / <sub>4</sub> " (10 ea./pk)	FMM 175
Multimaster saw blade 3 <sup>1</sup> / <sub>8</sub> " (5 ea./pk)	FMM 312C
Comes with a quick release, blades and sanding paper	



### Dotco Pneumatic Oscillating Saw

- Blade not included

Product No. **12S2065-90**



Tools

**Cast Cutter Blades**

- Not for use with Fein Cast Cutter

Description	Material	Product No.
2" SPS	Stainless Steel	<b>BL920</b>
2 <sup>1</sup> / <sub>2</sub> " SPS	Stainless Steel	<b>BL925</b>
2 <sup>1</sup> / <sub>2</sub> " (6 pack)	Stainless Steel	<b>4183-112</b>
2 <sup>1</sup> / <sub>2</sub> " Sectioned	Stainless Steel	<b>4183-145</b>
2"	Teflon Coated	<b>4183-114</b>
2 <sup>1</sup> / <sub>2</sub> "	Teflon Coated	<b>31-0265</b>
2 <sup>1</sup> / <sub>2</sub> "	Dicronite Coated	<b>0295-226</b>



**Synthetic Tubular Plastic Protective Cutting Strips (not pictured)**

- Used in casting
- Sold by each
- 3/4" x 24" long x 2 1/2" thick

Product No. **1010-24**

**Universal Alignment Fixture**

- For use with fracture brace joints

Product No. **220128**



**Joint Alignment Fixture**

- For use with stirrup alignment
- Size: Large

Product No. **220020**



**Stirrup Bender**

- Includes handle

Product No. **T041000000**

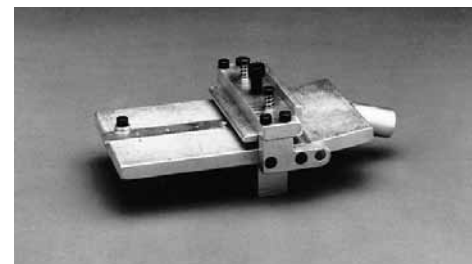



**Band Bender**

- Used for shaping leg bands
- Accommodates a variety of gauges and widths
- May be clamped in a vise or permanently mounted to a work bench

Product No. **203001**

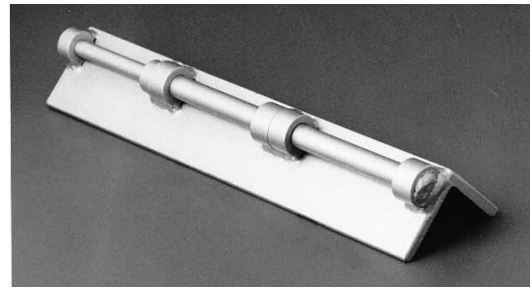

**Bending Irons**

- Used in pairs to bend metal brace uprights
- High quality forged steel, heat treated and plated
- One end designed to accommodate material 3/16" or less; opposite end for material 1/4" or less
- Rounded smooth jaw radius allow proper bends without damage

Description	Product No.
3/4" Head	<b>204001</b>
1/2" Throat	<b>204003</b>



**Becker Universal Alignment Fixture**

- Multipurpose tool for alignment of orthotic knee and ankle joints, including Oklahoma ankle joints

Product No. **MY-010-000**

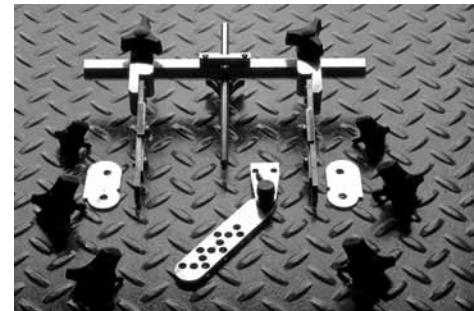

**Fillauer - Contouring Irons**

- Nickel plated bronze
- Wide-Radius jaws
- Will not mar finished metal or leather work; sold as pair

Product No. **220285**



**Model 2500 Trautman Bench Carver**

- Complete with a durable 1/4 HP, 115 Volt, AC, 60 Hz, 3,400 RPM single speed, brushless motor, this versatile, lightweight carver also features automatic thermal overload, adjustable height and tilt, a tool shaft extension of 10", and Trautman position locks
- The unit can be bench or vise mounted, with the base predrilled for 1/4" hold-down bolts

Product No. **2500/60**



Tools

**Model 2600 Variable Speed Bench Carver**

- Complete with a durable 1/4 HP, 115 Volt, AC, 60 Hz/50 Hz, 3,400 RPM variable speed, brushless motor and a programmable speed controller to provide the best results possible
- This lightweight carver also features automatic thermal overload, adjustable height and tilt, a height extension of 10", and Trautman position locks
- The unit can be bench or vise mounted, with the base predrilled for 1/4" hold-down bolts

Product No. **2600/60**



**Carver (Trautman)**

- Equipped with a 1/2 HP, single phase motor 50 to 60 cycle - 3450 RPM Motor A/C - 115/230V AC

Product No. **2100/60**



**Carver (Trautman)**

- Dual speed, 1/16-1/2 HP, 111V AC 60 Hz
- Single phase, 1725-3450 RPM

Product No. **2200/60**

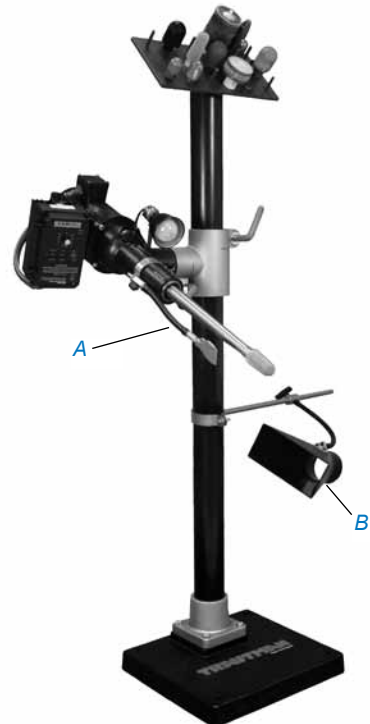

**Model 2300 Variable Speed Floor Carver**

- Precise speed control for best results possible
- Various speed range from 1380-3450 RPM
- Heavy-duty 3/4 HP Baldor® motor and controller
- Brushless motor for low maintenance
- Motor is thermally protected to prevent overheating
- Factory lubricated and sealed bearings for long-lasting use
- Pre-attached 40 watt work light
- Fully adjustable height and tilt can be set for a wide range of workers and applications
- Heavy-duty base for stability
- Torque overload set at factory to reduce the risk of injury
- Requires 115 V, 60 Hz electrical input shaft extension of 10", and Trautman position locks

Product No. **2300/60**

**Optional Equipment for 2100 and 2200**

**2100J Carver Air Attachment**

- Directs an adjustable air stream to blow dust and chips from the cutting tool
- Air hose can easily be connected to a standard 1/4" pipe fitting

**Trautman 2100K Carver Foot Switch**

- Allows hands-free stop and start operations for extra safety, convenience, and efficiency

Description	Product No.
A. Air Attachment	<b>2100J</b>
Foot Switch	<b>2100K</b>
B. Dust Collecting Attachment	<b>2100L</b>

**Dust Collection Hose Kit for 2100L**

- 4" diameter clear hose for viewing any obstruction
- Six feet of flexible hose reach
- 2 worm-drive clamps for connection
- Internal abrasion resistant
- Enclosed steel wire reinforced
- Hose kit includes vacuum hose and hose clamp

Product No. **226005**



Equipment

**Cutters**

Description	Product No.	
	Replacement Blade	Cutter
Midget Cutter	<b>2100HB</b>	<b>2100H</b>
Small Cutter	<b>2100AB</b>	<b>2100A</b>
Large Cutter	<b>2100BB</b>	<b>2100B</b>



**OPE - "The Rout-Man"**

Description	Product No.
<b>Regular Series</b>	
Single Speed 1/2 HP	<b>SS1/2 R</b>
Double Speed 3/4 HP	<b>DS3/4 R</b>
Variable Speed 3/4 HP	<b>VS3/4 R</b>
<b>Medium Series</b>	
Single Speed 1/2 HP	<b>SS1/2 M</b>
Variable Speed 3/4 HP	<b>VS1/2 M</b>
<b>Optional Accessories</b>	
Drawer	—
Display Panel	—
Dust Collector	<b>DCA01</b>
Electric Foot Switch	—



**Friddle's Variable Speed Router**

- Heavy Duty, 3/4 HP, 110 Volt Motor
- Adjustable speed drive, 0-3500 RPM
- Easily adjustable height/angle; Adjustable handles
- Includes 3 piece urethane arbor set

Description	Product No.
Variable Speed Router	<b>700063</b>
Foot Control Switch (optional)	<b>700-064</b>



**Shoe Systems Plus - The Mole**

- SAE standard 1/2" - 13 threaded shaft
- Includes: 2 speed power switch, 1725/3400 RPM; Foot switch; 3/4 HP motor; 36" arm and crank handle for quick adjustments

Product No. **MOLE2SP**



**The Mole - Variable Speed**

- SAE standard 1/2" - 13 threaded shaft
- Includes: Variable speed controller 0-3400 RPM; Foot switch; 3/4 HP motor; 36" arm and crank handle for quick adjustments

Product No. **MOLEVSP**



**Supreme Bench Carver**

- Bench top carver for prosthetic grinding jobs
- SAE standard 1/2" - 13 threaded shaft
- Includes: Low-torque 1/2 HP safety motor running at 3400 RPM
- Adjustable stand and predrilled base for bench mount

Product No. **SBC34**



**Supreme Bench Carver Stand**

- Perfect option for your Supreme Bench Carver
- Adjustable floor mounted stand

Product No. **SBCSTAND**

**Fillauer - Sand Drums**

Small: 2 <sup>1</sup> / <sub>4</sub> " OD x 2 <sup>1</sup> / <sub>2</sub> " Length	Product No.
Small Sand Drum	<b>2100F</b>
120 Grit Sand Sheet (Fine)	<b>F120</b>
60 Grit Sand Cone (Coarse)	<b>F60</b>

Large: 2 <sup>3</sup> / <sub>4</sub> " OD x 3" Length	Product No.
Large Sand Drum	<b>2100G</b>
120 Grit Sand Sheet (Fine)	<b>G120</b>
60 Grit Sand Cone (Coarse)	<b>G60</b>



**Sand Cores**

Mini: A=4 <sup>1</sup> / <sub>8</sub> " B=5 <sup>5</sup> / <sub>8</sub> "	Product No.
Mini Sand Core	<b>2100P</b>
50 Grit Sand Cone	<b>425 50</b>
100 Grit Sand Cone	<b>425 100</b>
120 Grit Sand Cone	<b>425 120</b>
180 Grit Sand Cone	<b>425 180</b>
Fine Buffer Cone (Blue)	<b>455-FINE</b>
Medium Buffer Cone (Maroon)	<b>455-MED</b>
Coarse Buffer Cone (Brown)	<b>455-COARSE</b>

Small: A=4 <sup>1</sup> / <sub>8</sub> " B=1"	Product No.
Small Sand Core	<b>2100D</b>
24 Grit Sand Cone	<b>426 24</b>
100 Grit Sand Cone	<b>426 100</b>
120 Grit Sand Cone	<b>426 120</b>
Fine Buffer Cone (Blue)	<b>456-FINE</b>
Medium Buffer Cone (Maroon)	<b>456-MED</b>
Coarse Buffer Cone (Brown)	<b>456-COARSE</b>

Medium: A=4 <sup>1</sup> / <sub>8</sub> " B=1 <sup>1</sup> / <sub>2</sub> "	Product No.
Medium Sand Core	<b>2100C</b>
24 Grit Sand Cone	<b>427 24</b>
100 Grit Sand Cone	<b>427 100</b>
Fine Buffer Cone (Blue)	<b>457-FINE</b>
Medium Buffer Cone (Maroon)	<b>457-MED</b>
Coarse Buffer Cone (Brown)	<b>457-COARSE</b>

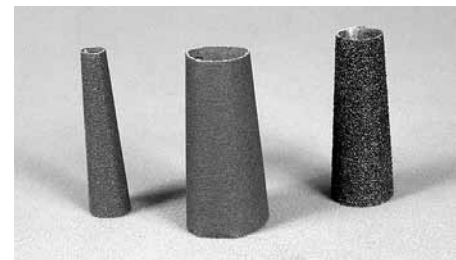
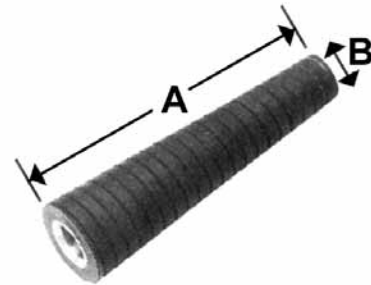

Sand Cone



Buffer Cone

Equipment

**Felt Arbor**

- Used for polishing edges of plastic laminate

Description	5/8" Thread	1/2" Thread
<b>Felt Arbor</b>		
2" x 3"	<b>225094</b>	<b>225066</b>
2 1/2" x 4"	<b>225086</b>	<b>225064</b>
3" x 4"	<b>225078</b>	<b>225062</b>
<b>Tapered Felt Arbor/Core</b>		
1" x 4" Tapered	—	<b>225072</b>
1 1/2" x 4" Tapered	<b>225177</b>	<b>225070</b>
2" x 4" Tapered	<b>225128</b>	<b>225068</b>
1/2" Urethane Arbor	—	<b>225082</b>

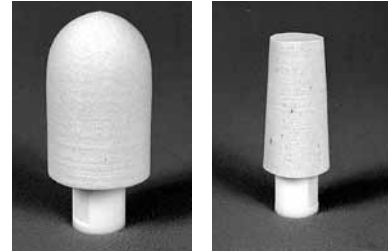

**Fillauer - Coneiak Polishing Arbors**

- These grinding and polishing arbors work well with any standard thermoplastic materials within the O&P industry
- The uniquely designed arbors come with a six month warranty and are currently available in four designs:
  - Grooved arbor: used for grinding radii
  - Tapered arbor: designed for polishing and grinding in small, tight areas
  - Ball Nose arbor: used for basic grinding and polishing
  - Slim arbor: designed for polishing and grinding inner surfaces of tight radii
- 1/2" - 13 Thread



Equipment

Description	Color	Product No.
Complete set of 4 with case	—	<b>225490</b>
Ball Nose	Orange	<b>225400</b>
Tapered	Red	<b>225410</b>
Grooved	Gray	<b>225420</b>
Slim	Blue	<b>225440</b>

**Qualis Manufacturing - Pneumatic Sanding Drum**

- Attaches to Trautman Carver

Size	Product No.
Large (5 1/4" long, 3 1/2" diameter)	<b>594000</b>
Small (3 1/2" long, 2 1/4" diameter)	<b>592500</b>

<b>Sanding Sleeves</b>		
Description	<b>Product No.</b>	
	Small	Large
24 Grit	<b>592524SM</b>	<b>594024LG</b>
60 Grit	<b>592560SM</b>	<b>594060LG</b>
80 Grit	<b>592580SM</b>	<b>594080LG</b>
120 Grit	<b>5925120SM</b>	<b>5940120LG</b>

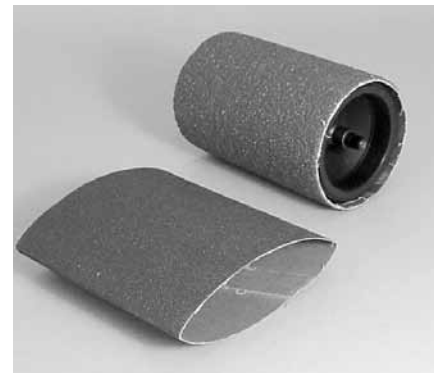

**Sanding Drum with Conical Hole**

- 73 x 200; for use on Trautman Router
- Non-threaded drum; use directly on shaft

Grit	Product No.
Sanding Drum	<b>064075-200</b>
40 Grit Sand Sleeve	<b>73440</b>
60 Grit Sand Sleeve	<b>73460</b>
80 Grit Sand Sleeve	<b>73480</b>
100 Grit Sand Sleeve	<b>73485</b>



**Trautman Accessories**

Description	Product No.
A. Soft Foam Shaper (5" x 2 <sup>3</sup> / <sub>4</sub> ")	<b>429</b>
B. B & G Rasp	<b>781400</b>
C. Trautman Adapter (1/2" x 5/8")	<b>225029</b>
D. Rasp	<b>2100E</b>
E. Trautman Drill Attachment (not pictured)	<b>2100S</b>
F. Ballnose Cutter, Fine (3/4" x 1 <sup>1</sup> / <sub>8</sub> ", 1/4" shaft) (not pictured)	<b>14-B34F</b>

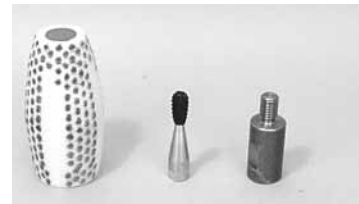

A B C

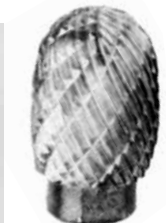

D

Equipment

**Tycro Cones**

Description	Product No.
A. Tycro Cone 3" x 4"	<b>R011-T</b>
B. Tycro Cone 1" x 4"	<b>R001-T</b>
C. Tycro Adapter	<b>R002-T</b>
D. Tycro 7A Fine Wheel	<b>02663</b>



A B C D

**Tycro Sander Kit**

- Available in M6 x 1/2" or M6 x 5/8"

Description	Product No.
Tycro Wheel with Glass Cloth	<b>52/6658-606</b>
Tycro Converter Seat	<b>52/6662-601</b>



Tycro Wheel



Tycro Converter Seat

**Adler Sewing Machine**

- The various types of equipment and the sturdy construction make the 367 most appropriate for sewing medium weight material in the production of shoes, leather articles, upholstery, tarpaulins and garments
- The sewing equipment and additional equipment developed with regard to practical requirements and the many suitable thread types leave nothing to be desired
- Features:
  - Bottom Feed
  - Wheel Bottom Feed
  - Alternating Foot Top Feed
  - Wheel Top Feed
  - Small or Large Hook
  - Thread Cutter
  - Single Needle or Twin Needle version with fixed or disengageable needle bars
- The standard safety clutch of the 367 prevents damages to the machine, even when sewing thick threads
- A central lubrication ensures reliable machine oiling at any speed and with any material thickness



*Adler Sewing Machine*



*Adler Patcher*

Description	Product No.
Adler Sewing Machine (head only)	<b>367K</b>
Adler Sewing Machine Table (20" x 48")	<b>367K Table</b>
Patcher	<b>30-10</b>
Patcher Power Stand	<b>Adler Patch Stand</b>

**Shoe Systems Plus - Claes Patching Machine**

- Long, slender lower arm reaches to the very end of most open end shoes
- Fine stitches on elegant ladies' shoes
- Even stitches on heavy work boots
- Up to 150 stitches per minute
- Sews in all directions; sews to 1/2" thickness
- 19 1/2" clearance under arm
- Adjustable speed, precision motor control
- Optional wood slide-on table for flatbed sewing
- Bobbin winder with automatic release
- 0-1/4" stitch length
- Optional: Jump Stitch; Slide-On Work Table; Sit-down or stand-up motorized stands available
- Specifications:
  - Width: 32"; Height: 58"; Depth: 15"
  - Net Weight: 175 lbs
  - Shipping Weight: 250 lbs
  - Voltage: 110-115 volts

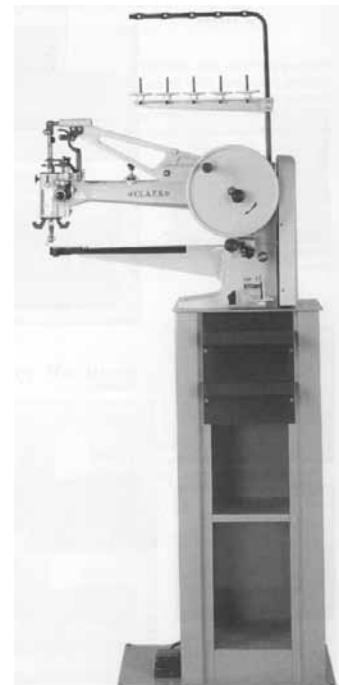

Description	Product No.
Claes 20 small bobbin (head only)	<b>CL834620</b>
Claes 30 large bobbin (head only)	<b>CL834630</b>
Stand	<b>Special order</b>



**Tannewitz - Drill Press**

Description	Product No.
13" Bench Top Model	<b>CH-16N</b>
13" Floor Model	<b>CH-16NF</b>

**17" Floor Type Drill Press Model**

- Spindle is supported by high quality ball bearings
- Cast iron pulleys reduce vibrations
- Comes with non-slip rubber feed handles
- 45° tilting table for angular drilling
- Locking depth stop for accurate blind hole drilling
- 5/8" drill chuck and key included
- 16-speed
- On-off switch for power and light located in front of the machine

Product No. **CH-18F**

**20" Floor Type Drill Press**

- 1 1/2 HP 1 PH motor provides ample power for production drilling
- Quill has an internal MT#3 to accept tapered drill
- Press accessories
- Production sized tilting table with coolant trough and clamping slots
- Positive depth stop for quick and easy adjustment
- 3/4" drill chuck and key included
- 12-speed
- Options: Drill Press Vise 3"

Product No. **CH-25**



CH-16N



CH-16NF



CH-18F



CH-25

Equipment

Drill Press Specifications			
Model	CH-16N/CH-16NF	CH-18F	CH-25
Drilling Capacity	5/8"	3/4"	1"
Drill Chuck Size	5/8"	5/8"	3/4"
Swing	13"	17"	21 1/2"
Spindle Stroke	3 1/8"	3 5/8"	4 13/16"
Spindle Distance to Table	17 1/2"	30 1/2"	27"
Spindle Distance to Base	24"	50"	47 1/4"
Table Size	11 7/16" dia	13 3/4" dia	18 5/8" x 16 1/8"
Spindle Taper	MT#2	MT#2	MT#3
Column Diameter	3 1/8"	3 1/8"	3 5/8"
No. of Spindle Speeds	16 speed	16 speed	12 speed
Range of Spindle Speeds	162-3500 RPM	240-3800 RPM	250-2600 RPM
Base Size	17 5/16" x 9 7/8" (16N) 17 3/4" x 10 1/2" (16NF)	17 5/16" x 10 5/8"	22 1/2" x 19 1/2"
Motor	3/4 HP 1 PH 115/230V Prewired 115V	1 HP 1 PH 115/230V Prewired 115V	1 1/2 HP 1 PH 115/230V Prewired 115V
Net Weight	99 lbs	160 lbs	326 lbs

**Tannewitz Advantage Series Band Saws**

- Loaded with state-of-the-art features that increase production while keeping costs to minimum
- Available in 24" and 36" throat capacities
- Each model delivers quality in a rugged saw that can handle sizable work loads in any plant
- Miter gauge and fence STD
- Sealed ball bearings
- Adjustable mitre gauge and rip fence
- Magnetic controls
- Precision machined tilting table
- Accurate blade tension indicator
- Sturdy rack and pinion guidepost
- Quality blade guides
- Four-sided blade guard with exclusive retracting rear guard
- Interlocking doors for safety
- Tracking windows

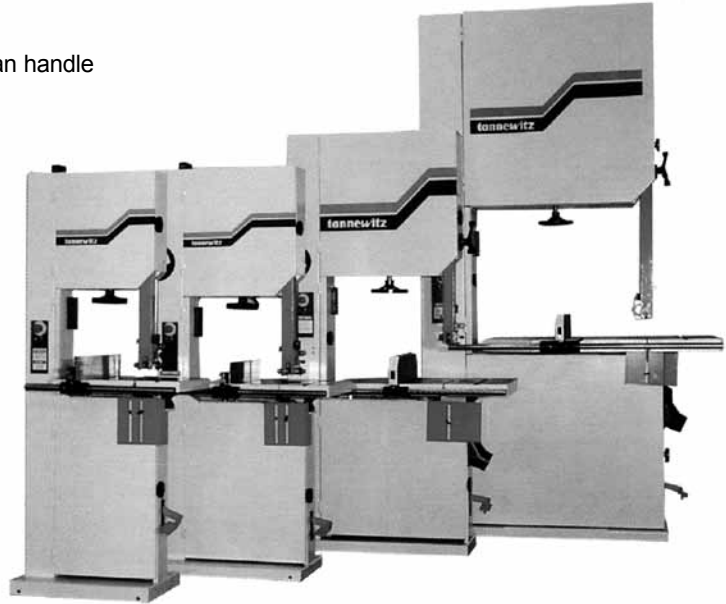

**Advantage Series Specifications**

Model	Advantage Band Saw 36"	Advantage Band Saw 24"
Throat Capacity (Max.)	35.8"	24"
Underguide Capacity (Max.)	22 Std	16 Std
Horsepower	10 HP Std 230/460 3 PH	3.6 HP 230/460 3 PH
Blade Speed	5500 SFM	5500 SFM
Wheel Diameter	37"	25.2"
Upper Wheel Adjustment	5"	2.5"
Blade Width	3/16" - 1 1/4"	3/16" - 1"
Table Size	31" x 45"	24 1/2" x 34 1/4"
Table Tilt	45° R, 5° L	45° R, 5° L
Table Height	44"	38 1/2"
Overall Height	112"	86"
Base Dimensions	38" x 68 1/2"	25" x 44 1/4"
Net Weight	2050 lbs	760 lbs
Blade Length	21' 9"	15' 6"

**Tannewitz Power Series Band Saws**

- More horsepower for resawing and contouring
- Heavy duty tension allows you to tension larger blades for faster and more accurate resawing
- Mitre gauge and rip fence
- Fully enclosed blade guards
- Magnetic controls
- Upper and lower door interlocks
- Roller guides, sealed bearings and tension indicator

Power Series Specifications				
Model	HB 500	HB 600	HB 700*	HB 950*
Throat Capacity	19"	22 <sup>7</sup> / <sub>8</sub> "	27"	36 <sup>1</sup> / <sub>2</sub> "
Resawing Capacity	13 <sup>5</sup> / <sub>8</sub> "	16 <sup>1</sup> / <sub>2</sub> "	18 <sup>5</sup> / <sub>8</sub> "	22"
Horsepower	3 HP, 1 PH, 220V 5 HP, 3 PH, 220/440V	5 HP, 1 PH, 220V 7.5 HP, 3 PH, 220/440V	10 HP, 3 PH, 220/440V	10 HP, 3 PH, 220/440V
Blade Speed	4750 SFM	5500 SFM	5500 SFM	5500 SFM
Wheel Diameter	19.7"	23.6"	27.5"	37.4"
Blade Width	<sup>3</sup> / <sub>16</sub> " - 1"	<sup>3</sup> / <sub>16</sub> " - 1"	<sup>3</sup> / <sub>16</sub> " - 2"	<sup>3</sup> / <sub>8</sub> " - 2"
Table Size	20 <sup>1</sup> / <sub>2</sub> " x 26 <sup>3</sup> / <sub>4</sub> "	24" x 31 <sup>1</sup> / <sub>2</sub> "	27 <sup>1</sup> / <sub>2</sub> " x 39 <sup>1</sup> / <sub>2</sub> "	33 <sup>1</sup> / <sub>2</sub> " x 55 <sup>1</sup> / <sub>8</sub> "
Table Tilt	45° right	45° right	45° right	45° right
Table Height	36"	38"	38"	45"
Overall Height	77 <sup>1</sup> / <sub>4</sub> "	86"	93"	115"
Machine Base	15" x 30"	15" x 34"	17" x 40"	51" x 21 <sup>3</sup> / <sub>4</sub> "
Net Weight	500 lbs	780 lbs	1100 lbs	2000 lbs
Blade Length	165"	188"	210"	261" - 264"

Equipment



HB 500



HB 600

\*HB 700 and HB 950 not pictured

**Donaldson Co. - Dust Collector**

- Motor: 3 HP, 3450 RPM, 230-460v/60/3 motor (specify operating voltages when ordering)
- Exhaust Outlet: 3<sup>1</sup>/<sub>2</sub>" x 9<sup>3</sup>/<sub>16</sub>"
- Dust Storage Area: 2 cu ft, standard; 3.5 cu ft, hopper-type
- Floor Space: 28<sup>1</sup>/<sub>2</sub>" x 28<sup>1</sup>/<sub>2</sub>"

Product No.

84



**Tannewitz Dust Collector**

- Cast iron motor cover, totally enclosed, fan-cooled
- Metal hose connector
- High air velocity; Upper bag support rod
- Heavy duty casters
- Strong metal strap for tightening collection bag quickly

Equipment



Model: DC-850

See through  
collection bag



Model: DC-1600

Upper bag  
support rod

Heavy duty  
caster



Model: DC-2350

Specifications			
Model	DC-850	DC-1600	DC-2350
Blower Wheel	10"	12"	12"
Air Flow Capacity at 4"	850 CFM	1600 CFM	2350 CFM
Static Pressure (inch of water)	7.2	14	14
Sound Rating at 3.3 ft	60-70 dB	67-77 dB	75-85 dB
Diameter of Hose Connection	4"	1 x 5", 2 x 4"	1 x 7", 4 x 4"
Bag Diameter	14 <sup>1</sup> / <sub>2</sub> "	19 <sup>1</sup> / <sub>2</sub> "	19 <sup>1</sup> / <sub>2</sub> "
Bag Length (top and bottom)	24 <sup>1</sup> / <sub>4</sub> "	32 <sup>1</sup> / <sub>4</sub> "	32 <sup>1</sup> / <sub>4</sub> "
Collector Bag Capacity	20 USG	42 USG	83 USG
Overall Dimension	31 <sup>1</sup> / <sub>2</sub> " x 16 <sup>1</sup> / <sub>2</sub> " x 61"	31 <sup>1</sup> / <sub>2</sub> " x 16 <sup>1</sup> / <sub>2</sub> " x 61"	61" x 24" x 78 <sup>3</sup> / <sub>4</sub> "
NW/GW	56 lbs/63 lbs	112 lbs/123 lbs	154 lbs/170 lbs

**Trinco - Model 36 Cabinet with BP Dust Collector**

- Inside Depth: 24"; Width: 36"; Height: 23"
- Overall Depth: 37"; Width: 38"; Height: 64"
- Front Door: 36" x 13" lid type
- Side Door: 17" x 11"

Description	Product No.
Model 36 Cabinet w/Dust Collector	100-00360
Replacement Rubber Gloves 24" Long	2-00047
BT10 Medium Glass Beads (50 lbs)	301-00010
Trinity Mix #4 Fine Glass Bead (50 lbs)	301-00004



**Double Drum Sander**

- Equipped with a 2 HP, 1725 RPM, 60 Hz with 1 phase 230/460V AC motor
- Includes motor control, pulleys, and belts

Description	Product No.
Single Phase	5005-1
3 Phase	5005-3

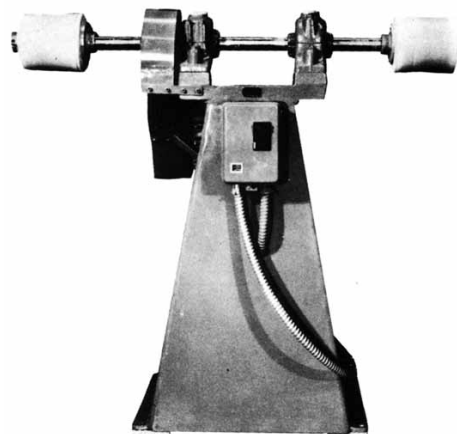

Double Drum Sander

**Arbor**

- Equipped with a 2 HP, 1725 RPM motor
- A 3 phase 230/450V AC with switch box, pulleys and belt or a Single phase 115/230V AC with switch and heater

Description	Product No.
Single Phase	5001-1
3 Phase	5001-3

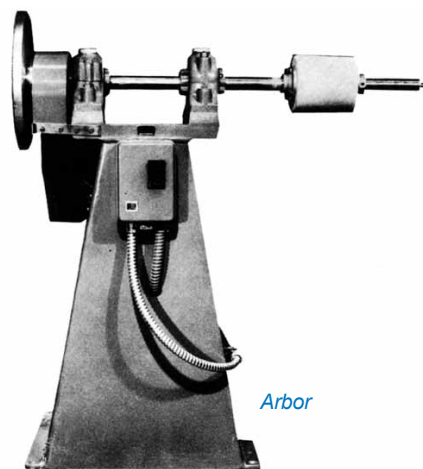

Arbor

**Sander**

- Equipped with 6" diameter x 7" wide and 3" diameter x 7" wide pneumatic drums and 3/4 HP single phase motor

Product No. **DD-63-DLX**

**Sander**

- Equipped with 6" diameter x 9" wide and 3" diameter x 9" wide pneumatic drums and 3/4 HP motor

Product No. **DD-63-9-DLX**



Sander

Equipment

**Steel Stand**

- Can be used with any model for floor use

Product No. **782270**

**Brush Head**

- The B-12 is excellent for deburring, sanding & polishing and is an ideal tool for satin finish; Abrasive is stored in the head
- Consists of 15 brushes (tampico and horse hair mix), 4" width, mounted in a machined aluminum casting
- Overall width is 5 1/4" with a 9" diameter; 1" bore is standard
- 60, 80, 120, 150, 180 or 220 grit

Product No. **B-12**

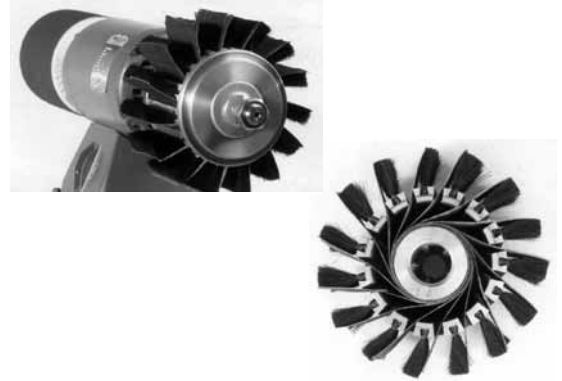

**Shoe Systems Plus - Supreme S-2000 Max**

- Vacuum system with high-speed adjustable trimmer
- Enhanced dust control; Direct drive blower; Heel breaster
- Two quick-change belts - 1 9/16" x 59" and 4" x 59"
- One sanding wheel - 2 1/2" x 6"
- One sanding wheel - 1 3/8" x 5" B-shaped on bayonet fitting
- Two horsehair brushes - 8" x 2"
- Two leather burnishers or laminated cloth wheels
- Edge iron friction heater
- Quick-adjust sole trimmer; High-speed heel trimmer
- Built-in precision cutter sharpener
- Adjustable high-speed naumkeg
- Front access dust collection drawer
- Six independently controlled motors, 230 volts, single phase
- Specifications
- Width: 75"
- Height: 62"
- Depth: 30"
- Net weight: 948 lbs
- Shipping weight: 1400 lbs

Product No. **SUPREMES2000UL**

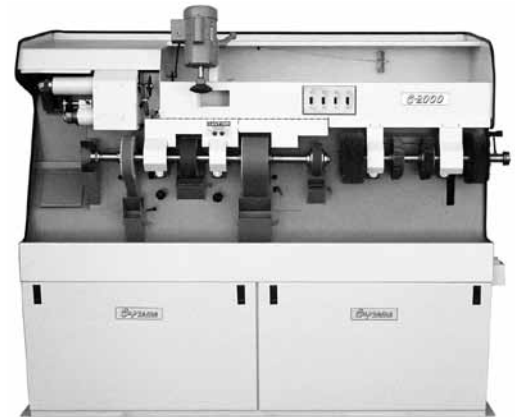

**Supreme S-1250**

- Intermediate level finishing machine
- Heel breaster; Front access dust collection drawer
- Two 59" sanding belts (1 1/2" and 4")
- Two high-speed adjustable trimmers (quick -adjust sole, adjustable heel)
- Two horse hair brushes 8" x 2" on separate shaft
- Precision cutter sharpener
- Adjustable naumkeg; Bag Shaker
- Five independent single-phase motors, 230 volts
- Specifications
- Width: 54"
- Height: 62"
- Depth: 30"
- Net weight: 802 lbs
- Shipping weight: 1200 lbs

Product No. **SUPREMES1250**



### Supreme S-750

- Compact versatile, high-performance
- Direct drive blower dust collection system
- Heel breaster; Bag Shaker
- Front access dust collection drawer
- Sanding belt 4" x 59"; cuts faster, lasts longer
- Sanding wheel 1<sup>3</sup>/<sub>8</sub>" x 6"
- Two brushes on bayonet fitting
- Built-in cutter sharpener; Adjustable naumkeg
- Two adjustable trimmers: 1 quick-adjust for soles, 1 adjustable for top lift
- Three single phase motors - 230 volts
- Specifications: Width: 36"; Height: 62"; Depth: 30"
- Net weight: 608 lbs
- Shipping weight: 740 lbs

Product No.

**SUPREMES750**



### Supreme S-6002H Standard Model

- Two quick-change 4" x 59" belts with easy access
- 3/4 HP direct drive dust collector motor
- Powerful 2 HP sander motor
- Sanding belt scrapers for more efficient dust control
- Dust port doors to maximize dust collection of work areas
- Front access dust collection drawer
- Comes with a heel breaster on bayonet and 8" x 2" soft Scotch Brite wheel on bayonet
- Dimensions: Width: 37"; Height: 62"; Depth: 25"
- Voltage: 230V
- Net weight: 520 lbs
- Shipping weight: 610 lbs

Product No.

**SUPREMES6002H**



### Supreme S-500 Finisher

- One sanding belt 4" x 59"; One sanding belt 1<sup>9</sup>/<sub>16</sub>" x 59"
- Heel breaster and horsehair brush, each on bayonet fitting, for quick-change to other optional attachments
- Powerful dust collection system with direct drive motor
- Front access dust collection drawer
- Easy access to belts
- One motor, single phase, 230/115V
- Optional second 4" belt
- Available with or without hoods
- Width without Hoods: 28"; Width with Hoods: 42"
- Height: 62"; Depth: 30"
- Voltage: 230/115V
- Net weight: 720 lbs
- Shipping weight: 800 lbs

Product No.

**SUPREMES500**



### Supreme S-400

- One sanding belt 4" x 59"
- 4" x 19" on track sanding belt with interchangeable bayonet
- Sanding belt scrapers for more efficient dust control
- Horse hair brush on interchangeable bayonet
- Powerful dust collection system with direct drive motor
- Suction doors to control maximum dust collection to work area
- Front access dust collection drawer
- Easy access to sanding belts
- Left side hood with suction for accessories
- Width with hood: 28<sup>1</sup>/<sub>2</sub>"; Width without hood: 21<sup>1</sup>/<sub>2</sub>"
- Height: 62"; Depth: 25"
- Net weight: 305 lbs
- Shipping weight: 450 lbs
- Voltage: 230V

Product No. **SUPREMES400**



### Supreme Mini Grind Pro

- 3/4 HP motor with fan
- 3400 RPM
- Compact design with handle
- Flat work surface on top
- Built in fan with self-contained dust removal system
- Adjustable hood for improved suction with accessories
- Quick-change bayonet shaft
- Large variety of tool options
- Options: Adjustable height stand; Long dust bag

Product No. **MGP34**



### Adjustable Stand

Product No. **MGP34BASEADJ**



### Work Master 1000

- Less than 3' of space
- 2000 RPM rotation with unstoppable power
- Direct drive blower creates powerful suction
- Powerful dust collection system with direct drive motor
- Interchangeable bayonet shafts allow a variety of grinding wheels
- Two 4" x 19" sanding belts
- Built to last, easy to service
- Optional Naumkeg available
- Dimensions: Width: 24"; Height: 57"; Depth: 24"
- Net weight: 340 lbs
- Shipping weight: 500 lbs
- Voltage: 230V

Product No. **WM1000**

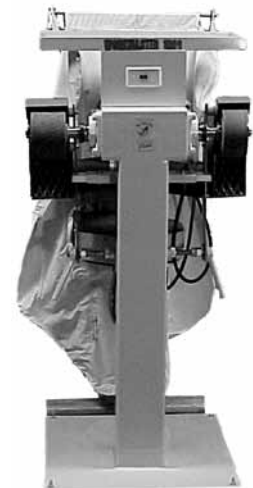



### Grind Pro Dual Drum Sander\*

- Two 7" wide, 3<sup>1</sup>/<sub>4</sub>" diameter pneumatic contour drums

Product No. **GPDUAL**

Description	Size	Product No.
ECB Carbide Wheel	2"	<b>ECB2</b>
- For the toughest jobs: Vibram, PVC, etc.	4"	<b>ECB4</b>
On Track Wheel	1 <sup>1</sup> / <sub>2</sub> "	<b>OTW112</b>
- A must for curved areas	3"	<b>OTW3</b>
	4"	<b>OTW4</b>
"B" Curved Carbide Wheel	4" x 2"	<b>CW42B</b>
	5" x 2"	<b>CW52B</b>
Flat Carbide Wheel	6" x 1 <sup>1</sup> / <sub>2</sub> "	<b>CW6112</b>
	6" x 4"	<b>CW64</b>

\*Special sizes available upon request



Equipment

### Optional Accessories

#### Tannewitz Stand

- Dimensions: 24" wide x 28" deep x 52" high
- Table: 10" x 22"; Tilts 45° up and 45° down
- Also available with non-tilt table
- Disc: 16" diameter, cast aluminum (356T6)
- Hub: 6" diameter, cast iron
- Motor: 1, 1<sup>1</sup>/<sub>2</sub> or 2 HP; 1 or 3 phase
- Starter: Magnetic
- Other sizes and models available

Product No. **16-SD**



**Sand Belts**

Description	Product No.
<b>4" x 59 1/2" Sand Belt</b>	
24 Grit	<b>B45924</b>
40 Grit	<b>B45940</b>
60 Grit	<b>B45960</b>
80 Grit	<b>B45980</b>
100 Grit	<b>B459100</b>
120 Grit	<b>B459120</b>
<b>1 9/16" x 59 1/2" Sand Belt</b>	
24 Grit	<b>B15924</b>
40 Grit	<b>B15940</b>
60 Grit	<b>B15960</b>
80 Grit	<b>BZ15980</b>
<b>4" x 42" Sand Belt</b>	
24 Grit	<b>BZ44224</b>
40 Grit	<b>BZ44240</b>



\*Note: The following information is needed to order accessories:

1. What is the name brand of your shoe machine? Sutton, Supreme, Stanley, etc...
2. Does your shoe machine have male or female ends on the main drive shaft?
3. Is the attachment point tapered or straight?

**Ordering Example**

Sutton, Male, Tapered . . . . . **A-5**

Equipment

**Pneumatic Drums and Sand Sleeves**

- 1" Bore; Cast zinc end rings and hubs, precision balanced and machined
- Abrasive sleeves available in 24, 36, 40, 60, 80, 100, 120, and 150 grit

Size	Pneumatic Drum	Canvas Covers	Rubber Bladder
7" x 6"	<b>782300</b>	—*	<b>781870</b>
7" x 4"	—*	—*	—*
7" x 3"	<b>782320</b>	<b>781820</b>	<b>781840</b>
9" x 8"	<b>782370</b>	<b>781830</b>	<b>781880</b>
9" x 6"	<b>782350</b>	<b>781825</b>	<b>781845</b>
9" x 4"	<b>782330</b>	—*	—*
9" x 3"	—*	—*	<b>781850</b>
8" x 2"	—*	—*	—*

\*Special Order only

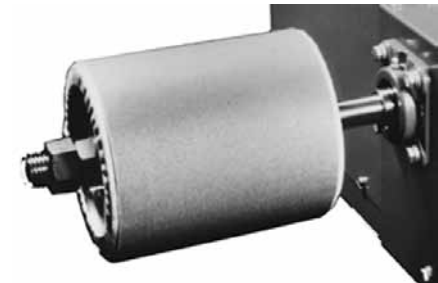

Grit	3"x7"	6"x7"	6"x9"	3"x9"	8"x9"	4"x7"
24	—	—	<b>771425</b>	—	<b>771505</b>	—
36	—	—	—	<b>771604</b>	—	—
40	—	<b>771370</b>	<b>771430</b>	<b>771605</b>	<b>771510</b>	<b>771320</b>
60	<b>771260</b>	<b>771380</b>	<b>771440</b>	—	—	<b>771330</b>
80	<b>771270</b>	<b>771390</b>	<b>771450</b>	—	—	—
100	<b>771280</b>	<b>771400</b>	—	<b>771630</b>	—	<b>771340</b>
120	<b>771290</b>	<b>771410</b>	<b>771470</b>	<b>771640</b>	<b>771550</b>	<b>771350</b>
150	<b>771300</b>	<b>771420</b>	<b>771480</b>	<b>771650</b>	—	—

















### Shoe Systems Plus - Sanding Discs

- 40 grit sanding disc with adhesive

Size	Product No.
12"	771801
16"	771799
20"	771810



Equipment

Description	Product No.	Description	Product No.
<b>8" Yarn Brush</b> - as shown with bayonet ..... <b>A-2</b> - refill only ..... <b>SU1209753</b>		<b>4 1/2" Bottom Sander</b> - as shown with bayonet..... <b>A-13</b> - wood and felt..... <b>BS412</b> - cams (1 set of 2)..... <b>BSC</b> - Blue Zirconia Sandpaper, 4 1/2" x 25 yd ..... <b>BZ41225??</b> <i>replace ?? with grit. 24, 40, 60 or 80</i>	
<b>8" Horse Hair Brush with Leather Burnisher, Black or Brown</b> - as shown with bayonet ..... <b>A-3-BLK</b> - as shown with bayonet ..... <b>A-3-BRN</b> - horse hair refill, Black ..... <b>P7142</b> - horse hair refill, Brown ..... <b>P7141</b> - curved leather burnisher refill ..... <b>LBC</b> - straight leather burnisher refill ..... <b>LBS</b>		<b>5" FS Wheel, Flat</b> - as shown with bayonet..... <b>A-16</b> - wood and felt..... <b>FS1385</b> - cams (1 set of 2)..... <b>FSC</b> - Blue Zirconia Sandpaper, 1 3/8" x 25 yd ..... <b>BZ13825??</b> <i>replace ?? with grit. 24, 40, 60 or 80</i>	
<b>8" Horse Hair Brush, Black or Brown</b> - as shown with bayonet ..... <b>A-4-BLK</b> - as shown with bayonet ..... <b>A-4-BRN</b> - refill only Black ..... <b>P7142</b> - refill only Brown..... <b>P7141</b>		<b>5" "B" Sanding Wheel, Curved</b> - as shown with bayonet..... <b>A-17</b> - wood and felt..... <b>B1385</b> - cams (1 set of 2)..... <b>FSC</b> - curved sandpaper, 1 3/8" x 25 yd 40 grit ..... <b>1382540B</b>	
<b>5" Wire Brush</b> - as shown with bayonet ..... <b>A-5</b> - refill only..... <b>SU1209756</b>		<b>Naumkeg Head</b> - as shown with bayonet..... <b>A-20</b> - sandpaper ..... <b>NAUMKEG ??</b> <i>replace ?? with grit. 80, 100 OR 120</i>	
<b>5" Grinding Stone</b> - as shown with bayonet ..... <b>A-6</b> - refill only ..... <b>SU1209741</b>		<b>Heel Breaster (for abrasive paper)</b> - as shown with bayonet Left..... <b>A-21-L</b> - as shown with bayonet Right..... <b>A-21-R</b> - refill only Left ..... <b>CALH</b> - refill only Right..... <b>CARH</b>	
<b>6" Flap Emery Wheel</b> - as shown with bayonet ..... <b>A-8</b> - refill only 120 grit ..... <b>SU1907174</b> - refill only 180 grit ..... <b>SU1907175</b>		<b>Pneumatic Wheel, 7" x 3 1/2"</b> - as shown with bayonet..... <b>A-24</b> - sanding sleeve, 7" x 3 1/4" 60 grit..... <b>SU1907170</b> - sanding sleeve, 7" x 3 1/4" 80 grit..... <b>SU1907169</b> - sanding sleeve, 7" x 3 1/4" 100 grit..... <b>SU1907171</b>	
<b>Laminated Cloth Wheel</b> - as shown with bayonet ..... <b>A-9</b> - refill only ..... <b>SU1201684</b>		<b>8" x 1" or 2" Scotch Brite Polishing Wheel</b> - as shown with bayonet 1" (Hard).... <b>A-25-81H</b> - as shown with bayonet 2" (Hard).... <b>A-25-82H</b> - as shown with bayonet 2" (Soft)..... <b>A-25-82S</b> - refill only 1" ..... <b>SU1200429</b> - refill only 2" ..... <b>SU1200430</b>	
<b>6" Welt Cleaning Brush</b> - as shown with bayonet ..... <b>A-10</b> - refill only ..... <b>ST6</b>			
<b>2 1/2" FS Sanding Wheel</b> - as shown with bayonet..... <b>A-12</b> - wood and felt..... <b>FS2125</b> - cams (1 set of 2)..... <b>FSC</b> - Blue Zirconia Sandpaper, 2 1/2" x 25 yd ..... <b>BZ21225??</b> <i>replace ?? with grit. 24, 40, 60 or 80</i>			

**The Fume Buster**

- Relieves much of the toxic chemicals from your work area
- Contaminated air is drawn through a sophisticated filter system and the clean air is returned back into the room
- Powerful 1/4 HP, 2 speed motor, 115 volts
- Comes equipped with a spark proof blower unit
- Purchase either vented or charcoal filtered model

Size	Product No.	
	Vented	Charcoal Filtered
3 ft	<b>FB36</b>	<b>FB36C</b>
4 ft	<b>FB48</b>	<b>FB48C</b>
5 ft	<b>FB60</b>	<b>FB60C</b>
Ultra 5 ft	<b>FBUCV</b>	<b>FBUC*</b>
*2 fans		



**19" Space Saver Fume Buster**

- On casters for easy mobility
- A giant against toxic fumes
- Can be filtered or vented

Product No. **FB19**

**Supreme Countertop Fume Master**

- New filtration system in a compact bench model
- No exhaust required
- Charcoal filter moves odors and fumes
- Install your cement, thinner and chemical products under the shelf
- Voltage: 115 Volts
- Specifications: Width: 24", Height: 29", Depth: 16"

Product No. **SupremeFM**



**Kleenair Purification Systems**

- Easy installation - wall installation takes only minutes
- Continuous re-circulation
- Standard power hook-up
- Minimal noise blower
- 100% synthetic blend media in aeropleat pre-filter

Description	Dimensions	Product No.
Air Purification System	—	<b>Kleenaire</b>
Carbon Filter	20" x 25" x 1"	<b>KCAR</b>
Pre-Filter	20" x 25" x 1"	<b>KPRE</b>



### Rebuilt 5 in 1 Leather Cutter

- Completely remanufactured and is like brand new
- One of the most use tools for any shop
- It's a welt roller, a sole cutter, a heel trimmer, an edge beveler, and a skiver all in one unique machine
- Top Blade (CSW-6), Bottom Blade (CSW-9)

Product No. **REB 5 IN 1**



### Supreme Mini Cutter

- 4" throat is perfect for orthopedic work
- Table mounted or additional height extender base available

Product No. **MC4**



### Supreme Maxi Cutter

- Extra long 10" throat
- Comes with an adjustable measuring guide

Product No. **MC10**



### Becker Orthopedic - The VacStation™

- The VacStation has been developed to deliver consistent dynamic performance standards
- Tests have proven the consistency of pressure during the molding process of vacuforming which reduces plastic warpage resulting in more consistent product quality
- The VacStation is a combination of unique and readily available components that may be purchased as a complete system or as componentry that may be incorporated into your system

Product No. **MY-005-000**

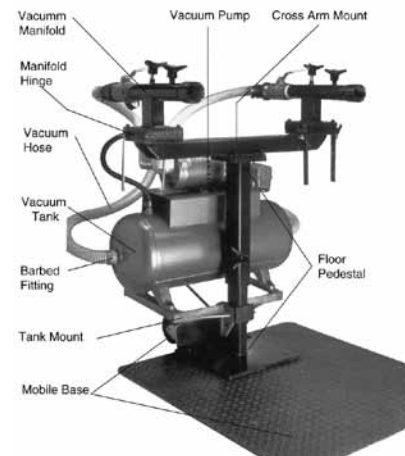

### Supreme LB Jack

- Bayonet mounted and swivelled on a solid steel base; comes with lasts

Product No. **SupremeLB6F**



**VacStation™ BT**

- The first bench top thermoforming system that combines a molding manifold and surge tank into one unit
- Easily mounted to your workbench, the VacStation BT is based on the same industrial process standard as our original VacStation thermoforming system
- Surge tank sized for all AFO, KAFO and TLSO fabrication
- Front mounted vacuum gauge
- Easily secured to your bench
- Simply connected to your existing vacuum system



Product No. **MY-006-000**

**Friddles - Complete Vacuum System**

- Pressure gauge and check valve
- 30 gallon surge tank
- Braided stainless steel hoses
- Adjustable vacuum pressure
- Automatic on/off switch
- 3/4 HP oil less vacuum pump
- 115 volt single phase
- Low maintenance



700-065H



700-065V

Description	Product No.
Horizontal Tank	<b>700-065H</b>
Vertical Tank	<b>700-065V</b>

**Hosmer - Portable Vacuum**

- 1/4 HP motor is permanently lubricated
- Enough power to operate two Vacuum Laminating Jigs simultaneously
- 4 cubic feet per minute capacity
- Adjustable vacuum from 3" to 27" of mercury
- Gauge, regulator, filter, hoses and overflow traps included
- Standard 110/115 volt 50/60 Hz Single Phase Motor
- 110 V standard plug and On/Off switch



Product No. **51277**

**Orthotics & Prosthetic Equipment (OPE) Corp. - Vacuum Systems**

- 3/4 HP oil less pump, automatic on/off
- 30 gallon tank
- 16"-25" of mercury



Description	Product No.
Single Pump	<b>785013</b>
Double Pump	<b>785014</b>

### Shoe Systems Plus - Gast Vacuum Pump

- Handles multiple vacuum pans at one time
- Includes:
  - Air cleaner to filter out dust and harmful particles
  - Exhaust silencer
  - Vacuum pressure gauge and one way check valve



Product No.

**GAST RVP**

### Supreme Spray Booth

- Supreme Spray Booth comes in two basic models:
- Model VT-1 with 6" exhaust for exterior venting
- Model VC-2 with a charcoal filter designed for safe use in shopping malls or where exterior venting is not possible
- Both models operate on 115 volts and come equipped with a 525 CFM exhaust system that effectively removes fumes and odors from the spraying operation
- 115 Volts
- Specifications: Width: 25", Height: 24", Depth: 23"



Supreme SB

Description	Product No.
VT-1 with 6" exhaust	<b>SupremeSB</b>
VC-2 with charcoal filter	<b>SupremeCSB</b>

Equipment

### Supreme Heat Activator

- Reduce cementing time while increasing quality with the Supreme Heat Activator for shoes and boots
- Will reactivate old cement quickly and dry wet shoes for instant repair
- Operates with six 250 watt infrared lamps; 115 Volts
- Specifications; Width: 21", Height: 28<sup>1</sup>/<sub>2</sub>", Depth: 16"



Supreme HA

Product No.

**SupremeHA**

**CO11-E Series Full Size Electric Convection Ovens**

- Full-size single and double, electric convection ovens with 10.5 KW per oven, and a patented two-speed, high-low fan-within-a-fan enhanced air flow system powered by an energy saving 1/4 HP motor
- Features include stainless steel front, top, sides and doors
- Synchronized doors are fully-insulated and feature “Cool Touch” handles, stainless door seals and double-pane thermal glass windows
- Lighted, porcelain enamel interiors have 11-position, removable rack guides and 5 racks
- Standard rotary controls are simple to use and include cool down function and continuous-ring timer
- The Cyclones are serviceable from the front and offer a full range of options and accessories



C011-E1



C011-E2

Description	Product No.	
	C011-E1	C011-E2
No. of Ovens	1	2
Oven Interior	29" x 22" x 20" 787 x 559 x 508 mm	29" x 22" x 20" 787 x 559 x 508 mm
Overall Dimensions	39 <sup>1</sup> / <sub>2</sub> " x 38 <sup>3</sup> / <sub>8</sub> " x 63 <sup>5</sup> / <sub>16</sub> " 1003 x 975 x 1607 mm	39 <sup>1</sup> / <sub>2</sub> " x 38 <sup>3</sup> / <sub>8</sub> " x 72 <sup>3</sup> / <sub>4</sub> " 1003 x 975 x 1848 mm
Ship Weight	660 lbs, 300 kilos	1220 lbs, 600 kilos
Electrical	208 or 220/240 volts 10.5 KWatts	208 or 220/240 volts 21 KWatts
Thermostat Range	150-550° F, 66-285° C	150-550° F, 66-285° C

**PDQ™ Ovens**

- Aluminum and stainless steel construction
- 650 watt infrared emitters (1000 watt on 8E)
- Interior light with double pane viewing window
- Programmable digital temperature controller
- Sheet-plastic tray with fitted Teflon® cover
- Full 1 year warranty
- 220 Volt single-phase



5A



BT-4

Interior Dimensions	Exterior Dimensions	Amps	Product No.
<b>Rollabout Models</b>			
38"W x 31"D x 18"H	49"W x 35"D x 48"H	30	<b>5A</b>
36"W x 51"D x 18"H	47"W x 55"D x 48"H	30	<b>6B</b>
48"W x 51"D x 18"H	59"W x 55"D x 48"H	30	<b>7C</b>
60"W x 48"D x 18"H	70"W x 52"D x 48"H	50	<b>8E</b>
<b>Prosthetic Oven</b>			
50"W x 36"D x 20"H	60"W x 40"D x 53"H	50	<b>PO-2</b>
<b>Benchtop Models</b>			
38"W x 30"D x 6"H	42"W x 43"D x 20"H	30	<b>BT-1</b>
27"W x 40"D x 24"H	32"W x 49"D x 61"H	50	<b>BT-4</b>



**PDQ™ Double Tray Rollabout 8D-2 Infrared Oven**

- Aluminum and stainless steel construction
- 1000 watt infrared emitters
- Two interior lights
- Two double pane viewing windows
- Programmable digital controller
- Two sheet-plastic trays with fitted Teflon® cover
- One combined tray with fitted Teflon® cover
- 220 Volt single-phase
- Interior Dimensions:  
39"W x 50"D x 18"H (each side)  
80"W x 50"D x 18"H (combined)
- Exterior Dimensions:  
92"W x 54"D x 48"H
- Electrical requirements: 220V, 70 amp, single phase



Product No. **8D-2**

**Teflon Fiberglass**

- Use on vacuum forming - transporting heated plastic sheets

Description	Width	Product No.	
		Foot	Yard
3 mil	38"	<b>T03/FT</b>	<b>T03/1YD</b>
10 mil	40"	<b>T10/FT</b>	<b>T10/1YD</b>

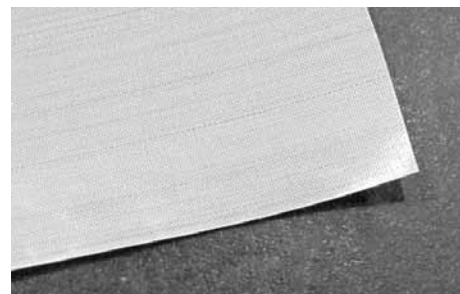

Equipment

**Eye Wash Stations**

**Bradley Eyewash Fountain**

- Delivers 2.6 GPM at 40 PSI
- Flow control for steady flow under varying water pressure conditions
- Large highly-visible safety yellow PVC push handle on chrome plated stay-open



Product No. **2P267**

**Bradley Eyewash Fountain**

- Same as 2P267 except has 10" diameter corrosion resistant stainless steel bowl



Product No. **4T009**

**Disposable Plaster Trap**

- Complete Trap Kit and Replacement Containers
- Plaster trap includes 2 permanent flexible hoses, 1 pipe adapter, and 1 disposable container
- The ready-made hoses connect the disposable container to the 1 1/2" sink tail pipe and wall sewer pipe

Description	Product No.
<b>Complete Kit</b>	
3 1/2 gallon	<b>TRP 3000</b>
5 gallon	<b>TRP 5000</b>
<b>Replacement Containers</b>	
3 1/2 gallon	<b>TRP 3001</b>
5 gallon	<b>TRP 5001</b>
10" Hose	<b>TRP0010</b>
12" Hose	<b>TRP0012</b>
18" Hose	<b>TRP0018</b>
24" Hose	<b>TRP0024</b>



Equipment

**Glass Rubber Cement Keeper**

- Replacement Brush =16 HH

Product No. **806900**

**Plastic Cement Dispense with Brush**

- Replacement Brush =16 HH

Product No. **806901**

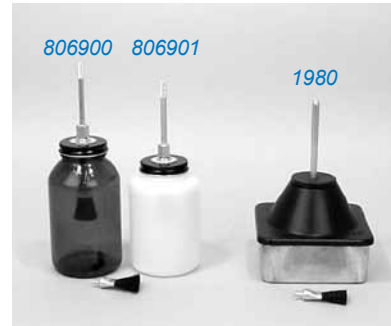

**ATCO Metal Cement Keeper with Replacement Brush**

- Look on keeper, if it is made in Taiwan use 1980-1 (Brush only)
- If it does not say Taiwan use 1979-1 (Brush only)

Replacement Brush **1980**

**Coats**

- Available in blue and white
- Even sizes: 34 to 48; also 50 and 52 in white
- Replace ?? with size
- Add "B" following size for Blue

Product No. **11380 ??**

**Jacket (not pictured)**

- Jacket length
- Available in blue and white
- Even sizes: 36 to 48; also 50 in white
- Replace ?? with size
- Add "B" following size for Blue

Product No. **11100 ??**



### Basic™ Shoe Covers

- One size
- Elastic side out, non-conductive
- Box of 100

Product No. **240265**



### Astrospec™ 3000 Protective Eyewear

- One-size-fits all adjustability
- Single piece, scratch-resistant polycarbonate lens adjusts to three positions for optimal fit and comfort
- 135 mm lens features molded-in side shields and brow guard for extra protection

Color	Product No.
Blue	<b>1798530B</b>
Patriot	<b>S-9931</b>
Black	<b>S-5685</b>



### Soft Frame Goggle

- Soft, ventilated, clear plastic frame provides maximum eye protection with comfort, wide vision
- Fits over prescription glasses

Product No. **AG#ST93060**



### Thermo Gloves

- Sold in pairs
- Color: Yellow

Product No. **S-7893**

### Heat Gloves

- Sold in pairs
- X-Large

Product No. **5325 153789**



### Hot Mill Gloves

- Only single pair needed when pulling plastics
- Color: White
- Sizes: Large/X-Large

Product No. **51/7146**

Equipment

***PDQ Oven Gloves***

- Terry cloth thermoforming gloves
- Extended length to protect forearms

Product No. **SUPGLOVE**



***The Respirator Mask***

- 20 per box
- Government certified
- To be used when dust conditions are greater than the Permissible Exposure Limit

Product No. **8200MMM**



***Dust Mask***

- 2-strap
- 20 per box

Product No. **8210MMM**

***Exam Table Paper***

- White: 225" roll

Size	Product No.
21"	<b>980914</b>
18"	<b>980912</b>

***Table Drawer***

- 20" wide
- The all-laminate drawer rolls effortlessly on nylon rollers with positive stops

Product No. **08**



***Paper Dispenser***

- 2 stainless steel "spring-action" brackets and removable metal rod
- Will accommodate paper rolls up to 21" wide

Product No. **23**



**Hausmann - Series 4002**

- H-Brace is recessed into table leg with unique 4-sided "lock-tite" joint
- High pressure laminate legs, apron and stretchers
- 2" high-density foam top



Series 4002

**Series 4024**

- H-Brace with laminate storage shelf
- High pressure laminate legs, apron and stretchers
- 2" high-density foam top



Series 4024

**Series 4041**

- H-Brace with laminate shelf and open-shelf storage cabinet
- High pressure laminate legs, apron and stretchers



Series 4041

Length	Width	Height	Product No.
<b>Series 4002</b>			
72"	24"	31"	<b>4002</b>
72"	27"	31"	<b>4002-027</b>
72"	30"	31"	<b>4002-030</b>
<b>Series 4024</b>			
72"	24"	31"	<b>4024</b>
72"	27"	31"	<b>4024-027</b>
72"	30"	31"	<b>4024-030</b>
<b>Series 4041*</b>			
72"	24"	31"	<b>4041</b>
72"	27"	31"	<b>4041-027</b>
72"	30"	31"	<b>4041-030</b>

\*Shown with option 05 - headrest

**Paper Cutter**

- Attaches to table at desired location
- Made of clear plastic with elastic ends, it cuts and then holds paper in place

Product No. **25**



**Paper Dispenser/Cutter**

- Consists of 23 and 25 sold as a combination

Product No. **27**

**Head Rest (not pictured)**

- Adjustable 20" length
- Elevates up to 45°

Product No. **05**

**Dial Scale (not pictured)**

- Durably constructed with an easy to read dial
- Weight capacity: 320 lbs
- Dimensions: 4<sup>1</sup>/<sub>2</sub>"H x 12<sup>1</sup>/<sub>2</sub>" W x 18<sup>1</sup>/<sub>2</sub>" D

Product No. **MPH07SF1**

**Digital Physician Scale (not pictured)**

- Durable steel construction with an epoxy finish
- Die-cast beams are easy to read from front and back
- Height rod measures up to 78"
- Weight limit: 400 lbs
- Color: White

Product No. **MPH071682**

**Folding Parallel Bars**

- Designed to easily fold to save space
- Unit is only 10" wide when folded
- Height adjustable from 28" to 41"
- Fixed width dimension of 25"

Length	Width	Height	Product No.
7'	25"	28" - 41"	<b>1319</b>
9'	25"	28" - 41"	<b>1318</b>



Model 1319

### Floor Mounted Parallel Bars

- Consists of (2) 1 1/2" diameter, one piece, stainless steel handrails and (4) floor mounted uprights with mounting plates
- Width adjusts from 15" to 28" wide with ergonomic hand control knobs

Length	Width	Height	Product No.
10'	15" - 28"	29" - 42"	<b>1340</b>
12'	15" - 28"	29" - 42"	<b>1342</b>
16'	15" - 28"	29" - 42"	<b>1344</b>



### Height and Width Adjustable Parallel Bars

- Width adjusts from 15" to 28" with ergonomic control knobs on each upright
- Platform 38" wide

Length	Width	Height	Product No.
10'	15" - 28"	29" - 42"	<b>1390</b>
7'	15" - 28"	29" - 42"	<b>1391</b>
12'	15" - 28"	29" - 42"	<b>1392</b>



Equipment

### Hausmann - Model 1671 Portable Single Mirror

- High quality, distortion-free glass mirror with ANSI "shatter-stop" safety backing
- Oak laminate frame and base
- Finished oak laminate back
- Mounted on easy rolling 2" diameter swiveling casters
- 24" wide x 70" overall height provides full body image
- 18" depth

Product No. **1671**



1671



1672

### Model 1672 Wall Mounted Mirror

- High quality, full view, distortion-free glass mirror with ANSI "shatter-stop" safety backing
- Oak laminate frame
- Equipped with mounting cleat for attachment to wall
- Mirror frame measures 66" x 24"
- Can be mounted 6" above floor so that overall height is 72"

Product No. **1672**

### "Mini" Staircase

- Space Saver can fit in 8 ft. high ceiling
- Two 6" high steps and three 4" high steps
- Steps are 30" wide
- Platform is 30" W x 24" D x 12" H
- Length: 52"

Product No. **1566**



**Foot Stool**

- Heavy duty chrome plated tubular legs with safety tips
- Non-slip threaded step
- Model 2002 packed 2 per case
- Length: 14"
- Height: 9"
- Depth: 11"

---

Product No. 2000



**Bariatric Foot Stool**

- Heavy duty chrome plated tubular legs with safety tips
- Reinforced steel cross-brace to accommodate up to 500 lbs
- Non-slip threaded step
- Length: 14"
- Height: 9"
- Depth: 10"

---

Product No. 2010



**Revolving Stool**

- 15" diameter seat, 3" thick foam
- Chrome steel with round foot ring
- (4) 2" twin wheel black nylon casters
- 18 vinyl colors available
- Diameter: 15"
- Height: 18"-24"

---

Product No. 2116



**5-Caster Revolving Stool**

- Adjustable worm gear height range of 6<sup>1</sup>/<sub>2</sub>"
- Fixed height rotation
- 5-Caster base offers greater stability
- 18 vinyl colors available
- Diameter: 16"
- Height: 21<sup>1</sup>/<sub>2</sub>"-27<sup>1</sup>/<sub>2</sub>"

---

Product No. 2150



**2153 Economy Air-Lift Stool**

- Single lever height control handle
- 18 vinyl colors available
- 6" height range
- Diameter: 15"
- Height: 20<sup>1</sup>/<sub>2</sub>"-26<sup>1</sup>/<sub>2</sub>"

---

Product No. 2153

