

Carbon Fiber AFOs

- Allard USA® 738

Static Positioning AFOs

- Anatomical Concepts 738-739
- LEEDer Group 740
- Orthomerica® 740
- RCAI® 741

Walking Boots and Night Splints

- Walking Boots 742-743
- Plantar Fasciitis/Posterior Night Splints 743

Air/Ankle Stirrups

- Ankle Stirrups 744-745

AFO Socks

- Comfort Products 746
- Knit-Rite® 746-747

Functional Electrical Stimulators

- Pediatric Walkaide System 747

Foot and Ankle

- Bledsoe Brace™ 748
- RCAI 748
- Trulife 748-749

Thermoplastic

- Allard USA 749
- Becker Orthopedic 750-752
- Creative Adaptations 752
- Gaffney Technology™ 752-753
- OTS 754
- Precision O&P 755

Ankle Joints and Stirrups

- Becker Orthopedic 756-763
- Trulife 763-765

Knee Joints

- Becker Orthopedic 766-771
- Fillauer 771
- OTS 772

Hip Joints

- Becker Orthopedic 773-776

Shoes

- Answer2® 777-779
- Apis 779
- Darco® 780
- Langer 780

Knee Orthoses

- Anatomical Concepts 781
- DeRoyal 781
- Lenjoy 782
- Palumbo 782
- RCAI 783-784
- Wheaton™ Brace Co. 784-785

Hip Orthoses

- AliMed® 786
- Allard USA 786-787
- Becker Orthopedic 788
- DeRoyal® 789
- Fillauer 789-790
- Orthomerica 790-791
- RCAI 792-793
- Rhino Pod, Inc. 793
- Trulife 793-794
- Wheaton Brace Co. 794

Upper Extremity

- Becker Orthopedic 803
- DeRoyal 795, 801, 804
- Knit-Rite 804-805
- LEEDer Group 796
- Lenjoy 796-799
- North Coast Medical 795
- OCSI/Neuroflex 800
- ProCare (DJO) 795, 800, 802
- Professional Products 803
- RCAI 795, 800-801, 803
- Truform 796

Cervical Orthoses

- Aspen Medical 806
- Becker Orthopedic 807
- Knit-Rite 807
- Ossur Americas® 808-809
- Symmetric Designs 809
- Trulife 810



Allard - KiddieGAIT™

- Offers a carbon composite framework for you to build an orthosis to encourage functional heel-to-toe gait
- While an SMO (molded inner boot) or UCB controls the foot
- The KiddieGAIT floor reaction frame adds dynamic response, lower leg anterior support and stability, and/or opportunity for management of the knee extension/flexion moment
- This combination offers a unique opportunity for you to customize function to meet specific patient needs
- Available in Black



Size	Height	Foot plate Length	Product No.	
			Left	Right
Baby Small	6"	4 1/4"	283721008	283722008
Baby Medium	7"	5"	283721009	283722009
Baby Large	7 3/4"	5 1/2"	283721010	283722010
Small	8 3/4"	6 1/4"	283721011	283722011
Medium	10"	7"	283721012	283722012
Large	11 1/2"	7 3/4"	283721013	283722013
SoftKIT Interface				
Baby Small	—	—	283970008	
Baby Medium	—	—	283970009	
Baby Large	—	—	283970010	
Small	—	—	283970011	
Medium	—	—	283970012	
Large	—	—	283970013	

STATIC POSITIONING AFOS

Anatomical Concepts - Dynamic Dorsi-Assist

- Dynamically stretch the gastroc muscles, offsetting equinus contracture
- Allows for virtually unrestricted range of plantar or dorsiflexion and inversion or eversion of the ankle/foot complex
- Two elastic straps attached at the distal foot section and proximal calf section can be adjusted to compensate and/or offset varus and valgus tendencies
- Maintains constant dorsi-assistive force and can be used for ambulation



Size	Foot Length	Foot Plate	Calf Height	Calf Circum.	Product No.
Infant	3 1/2"-6 1/2"	2 3/4"	6 3/8"-7 3/8"	13 1/2"	454RKG
Pediatric	4 3/4"-8 1/2"	3 1/2"	9"-10"	15"	554SKG



PRAFO®

- Totally adjustable, custom-fitted AFO that can help manage many of the ankle/foot anomalies your patients present you with
- Day and night comfort for children
- Effective with Spina Bifida and Cerebral Palsy patient population
- EV accommodates and helps control varus and valgus conditions

Description	Product No.	
	Infant	Pediatric
PRAFO with full Kodel liner	450RKG	550SKG
PRAFO Accessories		
Replacement Kodel liner	L40SKG	L50SKG
Replacement Calf Strap	C40SOB	C50SOW

Sizing Chart for PRAFO			
Size	Foot Length	Calf Height	Calf Circum.
Infant	3 ¹ / ₂ "-6 ¹ / ₂ "	6 ³ / ₈ "-7 ³ / ₈ "	13 ¹ / ₂ "
Pediatric	4 ³ / ₄ "-8 ¹ / ₂ "	9"-10"	15"



650EV PRAFO® EV, with Full Kodel® Liner

- Offers positive heel suspension; accommodates and helps control varus and valgus conditions of the ankle/foot complex
- Calibrated settings on the bar allow for a more accurate documentation of patient's progress
- Adjustable anti-rotation bar helps control unwanted extremity rotation

Size	Description	Product No.
Infant	With full Kodel Bootie	451RKG
Pediatric	With full Kodel Bootie	551SKG

Sizing Chart for 650EV PRAFO			
Size	Foot Length	Calf Height	Calf Circum.
Infant	3 ¹ / ₂ "-6 ¹ / ₂ "	6 ³ / ₈ "-7 ³ / ₈ "	13 ¹ / ₂ "
Pediatric	4 ³ / ₄ "-8 ¹ / ₂ "	9"-10"	15"



PKA - PRAFO® KAFO Attachment

- Reduces patient visits for adjustments to the ankle/foot segments of KAFOs, and improves patient compliance
- Bar and PKA system stops migration and rotation of your KAFO with practically no worry of skin impingement
- Foot lengths: Infant - 3¹/₂"-6¹/₂"; Pediatric - 4³/₄"-8¹/₂"

Description	Product No.	
	Infant	Pediatric
PRAFO KAFO Attach	050SKG	150SKG
PRAFO KAFO Attach/EV	—	151SKG



Pediatric
Foot and Ankle



LEEDer Group - LG-Kydex-Pro Ankle Foot Orthosis

- Professional MP Boot: Ambulation or Bed
- Easy application: wide closures for less pressure points (no straps)
- Adjustable anti-rotation bar prevents hip rotation and adjustable toe post

Indications: Non-fixed plantar flexion contracture; Plantar fasciitis; Equinovarus contracture limitation; Heel float; Foot drop; Achilles tendonitis; Heel decubitus

Size	Child Shoe Size	Product No.	
		Fleece	Vel-Foam
Pediatric	12-6	LBMP	LBMPNF



Orthomerica - Pediatric AFO

- Full range of sizes fits infants 2 months to 6 years
- Low-profile, effective for most applications
- Indicated for prevention of contractions and to aid in the treatment of patients with spastic hemiplegia or diplegia
- Leaf spring design allows for smoother gait pattern while maintaining stretch of hamstring and upright posture
- Trimmable polypropylene designed to fit into children's shoes

Size	Calf Circum.	Brace Height	Foot Length	Product No.	
				Left	Right
01	6"-7 ¹ / ₂ "	6 ¹ / ₂ "	4"	3581	3586
02	7 ¹ / ₂ "-9"	7 ¹ / ₂ "	4 ¹ / ₂ "	3582	3587
03	8 ¹ / ₂ "-9 ¹ / ₂ "	9"	4 ³ / ₄ "	3583	3588
04	9"-10 ¹ / ₂ "	10"	5 ¹ / ₄ "	3584	3589
05	10"-11 ¹ / ₂ "	11"	6"	3585	3590

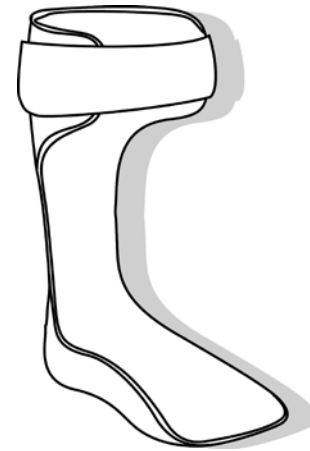

Pediatric UFO

- A comfortable, prefabricated orthosis for stretching and maintaining dorsiflexion range-of-motion
- Positions the foot and ankle in optimal alignment for placing stretch on the soleus while the patient is sleeping
- Universal sizing fits right or left
- For replacement liners, add .01 suffix (e.g., 3614.01)
- For Purple Butterflies transfer pattern, add .02 suffix
- For Tornado transfer pattern, add .03 suffix
- Surcharge applies for all transfer patterns
- Butterflies and Tornado transfers are stock items and available for same day shipment from vendor
- Other transfer options are subject to additional upcharge and require a two-day lead time from vendor

Size	Youth Shoe Size	Brace	Product No.
Small	0-7	6 ¹ / ₂ "	3614
Medium	7-10	8"	3615
Large	10-13	10 ¹ / ₂ "	3616



UFO shown with Butterflies transfer option



RCAI - Dorsiflexion Multi Podus®

- Provides adjustable static stretch of the plantar flexors
- Medial/lateral straps attached to the sides of the brace allow the foot and ankle to be controlled

Indications: Diminished foot and ankle range-of-motion; Pressure sores; Hip rotation

Size	Measure Foot Length	Product No.
Pediatric	4 1/2"-6"	11DFMP-P
Youth	6"-7"	11DFMP-Y



Phase II Multi Podus® System

- Adjustable positioning from 30° plantar flexion to 10° dorsiflexion in infinite increments, provides controlled static stretch correcting plantar flexion contractures
- Swivel rotator bar controls hip and leg rotation
- Inversion/eversion strap supplied simulates a T-strap on a short leg brace

Size	Measure Foot Length	Max. Calf Circum.	Product No.	
			Kodel Liner	Wicking Liner
Pediatric	4 1/2"-6"	10"	20MP-A-P	21MPO-A-P
Youth	6"-7"	13"	20MP-A-Y	21MPO-A-Y



Multi Podus® System

- Dynamically corrects foot/ankle contractures, and provides heel and toe clearance to prevent pressure ulcers
- Rotator bar at the back of the brace controls hip and leg rotation
- Bilateral Multi Podus Systems with a spreader bar provide controlled hip abduction
- Closed cell foam liner available for burn patients

Size	Measure Foot Length	Max. Calf Circum.	Product No.	
			Kodel Liner	Wicking Liner
Infant	3"-4"	8"	—	01MP-I
Toddler	4"-5"	10"	10MP-T	01MP-T
Child	5"-6"	10"	10MP-C	01MP-C
Youth	6"-7"	13"	10MP-Y	01MP-Y





Pediatric
Foot and Ankle



WALKING BOOTS/NIGHT SPLINTS



Pneumatic Walking Boots with Plastic Uprights

- Feature air cells for compression, stabilization and comfort
- Provide comfort and stability for fractures, soft tissue injuries or sprains of the ankle or foot
- Rocker bottom sole for less impact at heel strike

Aircast (DJO)	XP Walker - Extra Pneumatic					
	• 4 custom inflated aircells for individual fit and support					
		<u>US Shoe Size</u>		<u>Product No.</u>		
	Size	Men's	Women's			
	Pediatric	up to 4	up to 5	01P-P		
	FP Walker - Foam Pneumatic					
	• 2 custom inflated distal aircells					
	• Lightweight, low-profile design: rigid foot, flexible around calf for strength, fit and comfort					
		<u>US Shoe Size</u>		<u>Product No.</u>		
Size	Men's	Women's				
Pediatric	up to 4	up to 5	01F-P			
SP Walker - Short Pneumatic						
• Shorter height makes it ideal when limb length or calf circumference prohibits use of a standard height walking brace						
	<u>US Shoe Size</u>		<u>Product No.</u>			
Size	Men's	Women's				
Pediatric	up to 4	up to 5	01A-P			
DeRoyal	Inline Pneumatic Walker - Open Heel					
	• Wide foot plate for patient comfort and stability and threaded sole for patient safety					
	• Heavy duty flared uprights					
		<u>US Shoe Size</u>		<u>Product No.</u>		
	Size	Men's	Women's	Low Top		Standard Top
	Pediatric	8-12 (child)	—	15480002		15470002
Inline Pneumatic Walker - Closed Heel						
• Wide foot plate for patient comfort and stability and threaded sole for patient safety						
• Heavy duty flared uprights						
	<u>US Shoe Size</u>		<u>Product No.</u>			
Size	Men's	Women's	Low Top	Standard Top		
Pediatric	8-12 (child)	—	15500002	15490002		



Non-Pneumatic Walking Boots with Metal Uprights					
<ul style="list-style-type: none"> Provides comfortable stability for acute ankle sprains, soft tissue and stress fractures to the lower leg and ankle Adjustable air chambers to accommodate changes in edema during rehab and maximize patient compliance 					
ProCare (DJO)	MaxTrax ROM Walker <ul style="list-style-type: none"> ROM settings between 45° plantarflexion and 30° dorsiflexion in 7.5° increments Uprights will lock in fixed positions of 0°, 7.5°, 15°, 22.5°, and 30° plantar and dorsiflexion Ideal following Achilles tendon repair for controlled rehab 				
	<u>US Shoe Size</u>			Product No.	
	Size	Junior	Women's		
	Pediatric/X-Small	up to 5	up to 4	79-95332	





Plantar Fasciitis/Posterior Night Splints							
<ul style="list-style-type: none"> Designed to gently stretch the plantar fascia and Achilles tendon and prevent ankle contractures Lightweight, low-profile designs with adjustable straps Universal left or right 							
AliMed	Footdrop Night Splint™ <ul style="list-style-type: none"> Prevents heel cord and Achilles tendon shortening during prolonged bed rest Aliplast foam liner Foot plate set at angle slightly less than 90° 						
	Size	Calf	Instep	Metatarsal	<u>Product No.</u>		
	Infant	For infants (up to 18 months)			Left		Right
	Junior	Children (up to 7 years)			6771	6770	
					6773	6772	
AliMed	Pediatric Classic Night Splint <ul style="list-style-type: none"> Helps prevent heel cord and Achilles tendon shortening while sleeping Hook and loop straps adjust ankle/foot position from 10° plantar flexion to 10° dorsiflexion Fits left or right 						
	Size	Sizing			Product No.		
	Small	2-7			66141/NA/SM		
	Medium	7-10			66141/NA/MD		
	Large	10-12 ^{1/2}			66141/NA/LG		
RCAI	Plantar Fasciitis Night Splint <ul style="list-style-type: none"> Padded, contoured posterior shell Wide foam inset strap maintains proper foot alignment Includes toe wedge for additional stretch of the plantar fascia 						
	Size	Foot Length	Height	Product No.			
	Youth	up to 6 ^{3/4} "	12"	22PFNS-Y			

Pediatric
Foot and Ankle





Air Ankle Stirrups

- Air bladders provide compression and comfort
- Useful for ankle sprains, ankle instabilities

Aircast (DJO)	Air-Stirrup Ankle Brace <ul style="list-style-type: none"> • Semi-rigid, anatomically designed shells for protection, comfort, and the prevention of inversion/eversion • Patented Duplex™ aircell system to enhance circulation and reduce swelling 				
	Size	Height	Product No.		
	Pediatric	6"	Left	Right	
		02JL	02JR		
Ossur Americas	Airform Inflatable Stirrup Ankle Brace <ul style="list-style-type: none"> • Inflatable air bladders provide adjustable pneumatic compression • Adjustable, pivoting heel strap increases comfort and allows for full range-of-motion 				
	Size	Product No.			
	Youth/Pony	Left	Right		
		70200	70201		
	Airform Universal Inflatable Stirrup Ankle Brace - White <ul style="list-style-type: none"> • Soft Flex-Edges provide a universal fit • Inflatable air bladders provide adjustable pneumatic compression 				
Size	Product No.				
Youth	Each	6/pack			
	80251	802516			
Airform Pre-Inflated Stirrup Ankle Brace <ul style="list-style-type: none"> • Pre-inflated, pulsating air bladder with regulated chambers reduces bottoming out and decreases edema • Adjustable, pivoting heel strap 					
Size	Product No.				
Youth/Pony	Left	Right			
	70100	70101			



Gel/Foam Ankle Stirrups						
<ul style="list-style-type: none"> • Features gel/foam padding for added comfort • Useful for ankle sprains, ankle instabilities 						
Ossur Americas	Form Fit® with Honeycomb Ankle Brace					
	<ul style="list-style-type: none"> • Patented honeycomb gel pads • Flex-edges and adjustable pivoting heel strap 					
	Size	Product No.				
	Youth/Pony	<table border="1" style="width: 100%;"> <tr> <th style="width: 50%;">Left</th> <th style="width: 50%;">Right</th> </tr> <tr> <td style="text-align: center;">40100T</td> <td style="text-align: center;">40101T</td> </tr> </table>	Left	Right	40100T	40101T
	Left	Right				
	40100T	40101T				
Form Fit Foam Ankle Brace						
<ul style="list-style-type: none"> • Patented 3-dimensional molded pads • Flex-edges and adjustable pivoting heel strap 						
Size	Product No.					
Youth/Pony	<table border="1" style="width: 100%;"> <tr> <th style="width: 50%;">Left</th> <th style="width: 50%;">Right</th> </tr> <tr> <td style="text-align: center;">20100C</td> <td style="text-align: center;">20101C</td> </tr> </table>	Left	Right	20100C	20101C	
Left	Right					
20100C	20101C					
Gel Ankle Brace						
<ul style="list-style-type: none"> • Safe hot/cold therapy • Patented lace-lock feature • Available in 50% surface gel or 80% surface gel 						
Size	Product No.					
Youth/Pony - 50% Gel	<table border="1" style="width: 100%;"> <tr> <th style="width: 50%;">Left</th> <th style="width: 50%;">Right</th> </tr> <tr> <td style="text-align: center;">E200PLC</td> <td style="text-align: center;">E200PRC</td> </tr> </table>	Left	Right	E200PLC	E200PRC	
Left	Right					
E200PLC	E200PRC					
ProCare (DJO)	Surround FLOAM™ Ankle					
	<ul style="list-style-type: none"> • Provides stability to the ankle by minimizing ankle rotation • Comprised of two polypropylene outer shells connected with soft, adjustable foot piece • FLOAM™ bladder provides uniform compression and a customized fit 					
	Size	Height		Product No.		
Pediatric	6"	79-81193				

Pediatric
Foot and Ankle



Comfort Products - AFO Liner Socks

- Available in the following styles:
 - Traditional: All cotton, fully terry lined
 - CoolMax™: Wicks moisture away from skin
 - SilverMax™: Combines X-Static silver and CoolMax
- Available three pair (6 socks) per package

Size	Black Cotton/Nylon	Natural Cotton	White CoolMax	Silver SilverMax
Child's 4-6 ¹ / ₂	AFOLSB04	AFOLS04	AFOLSCM04	AFOLSX04
Child's 6-8 ¹ / ₂	AFOLSB06	AFOLS06	AFOLSCM06	AFOLSX06
Child's 12 ¹ / ₂	AFOLSB09	AFOLS09	AFOLSCM09	AFOLSX09



Knit-Rite - SmartKnit® AFO Interface Socks

- Seamless knitting and form fitting core-spun yarns help eliminate wrinkling, bunching and seam pressure
- Provides exceptional softness, moisture wicking and antimicrobial to help prevent odor in the sock
- "Heel-less" design ensures a perfect fit every time
- Sold as Pair

Size	Width/Length	Product No.		
		White	Pink	Purple
Infant	2" x 9"	1SP1AFNF	1S21AFNF	1S31AFNF
Child Small	2 ¹ / ₄ " x 11"	1SP1AFCS	1S21AFCS	1S31AFCS
Child Regular	2 ¹ / ₂ " x 14"	1SP1AFCR	1S21AFCR	1S31AFCR
Child X-Long	2 ³ / ₄ " x 20"	1SP1AFCX	—	—



AFO Interface Socks with X-Static® - The Silver Fiber™

- Sold as Pair

Size	Width/Length	Product No.		
		Navy	Gray	Black
Infant	2" x 9"	1NX1AFNF	1SX1AFNF	1BX1AFNF
Child Small	2 ¹ / ₄ " x 11"	1NX1AFCS	1SX1AFCS	1BX1AFCS
Child Regular	2 ¹ / ₂ " x 14"	1NX1AFCR	1SX1AFCR	1BX1AFCR
Child X-Long	2 ³ / ₄ " x 20"	—	1SX1AFCX	—



SmartKnit® AFO Liner™

- Innovative protective sleeve covers the AFO, not the leg
- Shields the wearer’s skin from direct contact with the AFO reducing sheering and chafing
- Provides breathable cushion for the foot without being hot or bulky
- Sold each



Size	Size (inches)	Flap Length	CoolMax White	Polyester Tan	X-Static Black
Child Small	2 ³ / ₄ x 2 ³ / ₄ x 7	5"	1SP1ABCS	—	—
Child Regular	3 x 3 x 9	5"	1SP1ABCR	1TP1ABCR	1BX1ABCR

SmartKnit AFO Liner Sizing Chart				
Size	Overall Length	Upper Width	Mid-Calf Width	Ankle Width
Child Small	11"-14"	4"-8"	3 ¹ / ₂ "-6"	3 ¹ / ₂ "-7 ¹ / ₂ "
Child Regular	13 ¹ / ₂ "-17 ¹ / ₂ "	4"-8"	3 ¹ / ₂ "-6"	3 ¹ / ₂ "-7 ¹ / ₂ "

FUNCTIONAL ELECTRICAL STIMULATORS

Innovative Neurotronics - Pediatric WalkAide System

- Pediatric cuff designed to fit small children
- Amplitude, frequency, pulse duration settings for sensitive cases; well-tolerated
- Adaptive program and modular components through growth and maturity
- Single unit system with no extra pieces, ideal for playful kids
- Operates up to 30 days on on AA battery - no need for nightly charges
- Promotes natural, efficient and safe multidirectional walking
- Allows kids to have more freedom in footwear or no shoes at all

Description	Circumference	Product No.
WalkAide Unit	—	20-1000
Bi-Flex Cuff	7 ¹ / ₂ "-10"	20-0240B

Washable Liner promotes patient comfort and hygiene

Vented Design allows for increased air circulation and increased breathability



Customizable Strap
Kid-friendly optional ribbons*

Pediatric Bi-Flex Cuff

Pediatric
Foot and Ankle



Bledsoe Brace - Wee Walker

- Fits children as young as 1 year
- Heel height, width and rocker bottom designed for small children
- Forefront straps immobilize the ankle

Indications: Ankle sprains and fractures; Forefoot fractures; Forefoot sprains and stable distal tibia fractures

Size	Age in Years	Foot Length	Leg Length	Product No.
Small-Medium	1-2	up to 6"	up to 9"	AL185003BB
Large	2 ¹ / ₂ -6	6"-7 ¹ / ₂ "	up to 11"	AL185007BB
X-Large	6 ¹ / ₂ -9 ¹ / ₂	7 ¹ / ₂ "-8 ¹ / ₂ "	up to 14"	AL185009BB



**RCAI - Pediatric TA Boot 78TA-R (ROM)
78TA-S (Static)**

- Secondary immobilization and rehabilitation for the foot and ankle
- Low-profile heel and rocker bottom enhances natural gait and hip alignment
- Available with static or ROM hinges to provide optimal mobility adjustments

Size	Max. Calf Circum.	Foot Length	Product No.	
			ROM	Static
Infant	7 ¹ / ₂ "	4 ¹ / ₂ to 5 ¹ / ₂ "	—	78TA-S-I
Toddler	8 ¹ / ₂ "	5 ¹ / ₂ to 6 ¹ / ₂ "	—	78TA-S-T
Child	13"	6 ¹ / ₂ to 8"	78TA-R-C	78TA-S-C
Youth	14"	7 ¹ / ₂ to 9"	78TA-R-Y	78TA-S-Y



Trulife - Matrix Max Mini Raw

- Made of lightweight, carbon composite
- Ready for the practitioner to create a custom KAFO or AFO
- Shrink tubes, stainless steel inserts and hardware included
- 10 pack contains 5 left and 5 right

Indications: CP, spina bifida and idiopathic toe walking

Description	Height	Foot Plate	Product No.	
			Left	Right
Matrix Max Mini Raw, single	13 ¹ / ₂ "	8 ¹ / ₂ "	FH235-L	FH235-R
Matrix Max Mini Raw, 10/pk	13 ¹ / ₂ "	8 ¹ / ₂ "	FH236	



Bebax Tri-Plane Pediatric Forefoot Orthosis

- Innovative orthosis allows progressive and dynamic correction of congenital forefoot deformities
- Minimizes retractions from muscular or neurological disorders
- Patented multi-directional hinge adapts easily for correction in all 3 planes
- Serial casting contact molding to forefoot and heel without plaster
- Removable for stretching and hygiene
- Adjusts progressively for proper fit



Foot Size	Foot Length	Pair	Product No.	
			Left	Right
Pediatric Sizes				
01	3"	0873001	08731L01	08731R01
02	3 ¹ / ₁₀ "	0873002	08731L02	08731R02
03	3 ³ / ₁₀ "	0873003	08731L03	08731R03
04	3 ¹ / ₂ "	0873004	08731L04	08731R04
05	3 ⁷ / ₁₀ "	0873005	08731L05	08731R05
06	3 ⁹ / ₁₀ "	0873006	08731L06	08731R06
Toddler Sizes				
07	4 ¹ / ₁₀ "	0873007	08731L07	08731R07
08	4 ¹ / ₂ "	0873008	08731L08	08731R08
09	4 ⁹ / ₁₀ "	0873009	08731L09	08731R09
10	5 ³ / ₁₀ "	0873010	08731L10	08731R10

THERMOPLASTIC

Allard - KID-Dee-Lite™ Pediatric Ankle Joint

- Allows early dynamic ankle/foot management for the child with neuromuscular disorders
- Plantar and dorsal adjustment of 40°
- Weighs only 200 grams (0.7 oz.) when used in a thermoplastic or laminated orthosis
- A curved upright blank is included to be used when the orthosis requires thermoplastic changes above the joints for tibia control
- The tapered hinge can be turned to position the shorter upright up or down to accommodate orthosis requirements
- Kit includes: alignment tube, curved (blank) and straight uprights, assembled joints and mounting components
- One size stainless steel with 55 lb weight limit

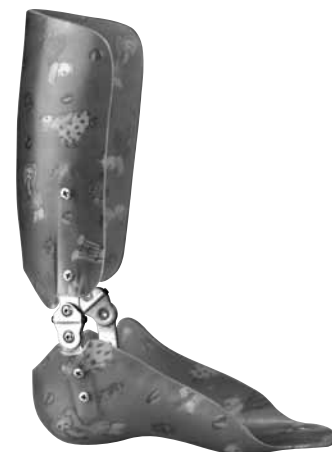

Pediatric
Foot and Ankle

Product No.

790



Becker Orthopedic - Gillette Double Flexure Ankle Joint

- Provides a full range of options for joint motion and control in thermoplastic orthoses
- Retains varus/valgus rigidity for proper maintenance of alignment
- A softer ankle joint for applications that require maximum functional stretch
- Joints do not need to be perfectly square



Size	Dimensions	Product No.
Infant	3/8" x 1 1/8"	775-I
Pediatric	3/8" x 1 3/8"	775-P
Child	7/16" x 1 15/16"	775-C

Tamarack Flexure Joint®

- A self-aligning flexure joint technology that self-co-aligns the medial and lateral joint axes
- Unique high strength inner core prevents elongation and ensures precise hinging action
- Provides the strength and precision required for virtually all ankle joint applications
- Manufactured from durable urethane

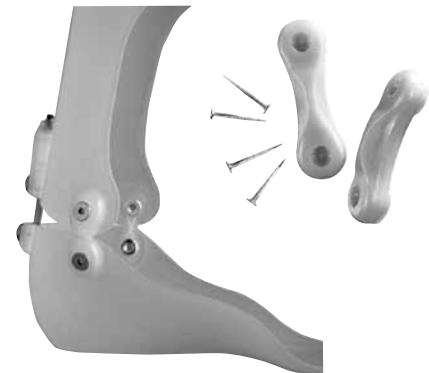

Size	Dimensions	Dummies	Product No.	
			Flexure Joint	Black
Pediatric	.41" x 1.25"	741-P	740-P	740-P-BLK

Gillette Dorsiflexion Assist Ankle Joint System

- Provides ease of fabrication and cosmetic appeal
- Actual dorsiflexion assist varies with patient's foot length, neuromuscular characteristics and physique
- Silver, clear and gold adult provide 1, 2, and 3 lbs approximately of assistance for toe lift
- Colors may be interchanged to match patient requirements



Size	Dimensions	Clear	Product No.	
			Gold	Silver
Child	7/16" x 1 3/4"	776-CC	776-CG	776-CS

Gillette Ankle - Replacement Parts

Size	Bushings	Product No.	
		Screw	Posterior Stop
Pediatric/Infant	775-P1	775-P2	*775-PS-PI
Child	775-C1	775-C2	*775-PS-C

*Sold 10 per pack



Tamarack® Spanner Wrench

- Spring-loaded retractable center pin, which helps hold and align the flange nut for easier installation of the dorsiflexion assist joints
- Spanner pin matches up with four notches in the flange nut
- This also makes for easier removal of the joints in the presence of 740 or 742 style joints



Product No. **T-740-3P**

Tamarack Dorsiflexion Assist Flexure Joint®

- Biased design provides motion assist similar to traditional metal dorsi-assist ankle joints
- Provides motion assist for elbow, wrist, pediatric knee orthoses and the full range of AFO's
- Unique inner core to extend joint life and minimize joint elongation



Size	Dimensions	Product No.		
		75 Durometer	85 Durometer	95 Durometer
Pediatric	.41 x 1.25"	742-P-75	742-P-85	742-P-95

Tamarack Variable Assist™ Kit

- Compact mounting hardware allows continuously variable adjustment of the dorsiflexion-assist moment
- Design allows practitioner to adjust the assist moments of joints to any value from zero to nearly three times what is possible with standard installation
- Kit includes: joints, molding dummies, shearbar, stainless steel mounting hardware, check strap and hex key



Size	Dimensions	Product No.
Pediatric	.72" x 1.7"	743-P

Camber Axis Hinge® Kit

- Provides anatomical alignment due to the center offset
- Range-of-motion or fixed ankle position can be set by inserting the color coded keys included
- All keys can be interchanged or reversed from solid ankle to limited motion of plantar or dorsiflexion
- Eliminates the need for posterior motion controls



Size	Dimensions	Stainless Steel	Black
Small	3 ¹ / ₈ " x 1 ¹ / ₈ "	750-S	750-Black-S

Pediatric™
Thermoplastic



Plantar Flexion Stop

- Manufactured in stainless steel and durable urethane
- Provides a variable plantar flexion control which can be locked in any position
- The urethane bumper provides impact and sound dampening

Product No. **795**

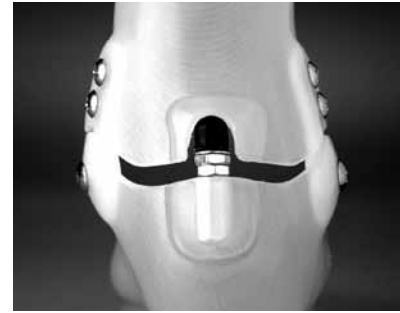

Oklahoma Ankle Joint

- Can be preheated, shaped, attached to the cast, prior to vacuum forming
- Incorporates a unique design of ridges and grooves to lock the joint in place when vacuum formed
- Comes with pre-drilled holes to facilitate alignment and a plastic bushing to reduce wear

Size	Dimensions	Standard (Polypro)	Heavy Duty (Nylon)
Pediatric	1 ⁵ / ₁₆ " x 2"	760-P	765-P
Child	1" x 2 ⁵ / ₈ "	760-S	765-S

Replacement Parts - Oklahoma Joints	
Description	Product No.
Attachment Screw for Pediatric and Small	761-1
Threaded Insert for Pediatric and Small	761-2
Pivot Bushing & Screw - All Sizes	761-5
Nylon Bushings - All Sizes	761-6
Adhesive Foam Pad	761-7P
Pelite Pad	761-8P



Creative Adaptations - TC Ankle Stop

- Placed on the posterior side of a plaster mold before vacuum forming, this device will allow the patient to change the degree of plantar flexion stop on the finished AFO with adjustable noise limiting bumpers

Product No. **102TCP**



Gaffney Technology - Flexor Dorsal Flexion Assist

Size	80 Durometer		85 Durometer	
	Replacement Straps	Gaffney Flexors	Replacement Straps	Gaffney Flexors
Child	2010	2000	2010-C	2000-C

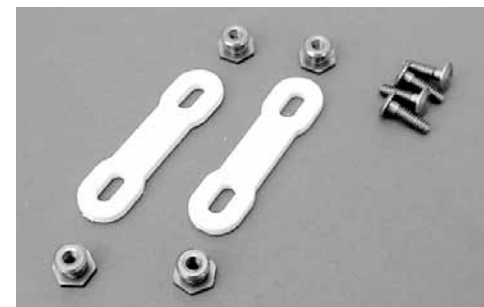

Pediatric Ankle Hinge Kits

- All hinge kits are made of 10 gauge stainless steel
- All hinge kits include 2 hinges plus all necessary components, screws, bumpers and nails plus instructions

510 - Pony

- Width: 7/16"; Length: 2"
- Designed for the small child to avoid the distal portion of hinge from interference with the control area and to help in shoe space problems

Product No. **510**

505 - Colt

- Width: 7/16"; Length: 1 1/2"
- Designed for the newborn to 1 1/2 years
- Allows for the minimum amount of hinge necessary on your patient while still performing the function needed

Product No. **505**

660 - Stallion

- Width: 7/16"; Length: 2 1/2"
- Designed for children up to small adults

Product No. **660**

747 - Shetland

- Width: 9/16"; Length: 3"
- Adjustable stop for use on children 80 lbs or less
- Ideal for heel cord lengthening post-operative

Product No. **747**

Adjustable Alignment Fixture

- Each set includes four adjustable tools and starter rod, with a solid polyurethane tool holder
- Designed to save time and assure proper alignment

Description	Product No.
For Children's Hinges	A-300

Hinge Repair Kits

- All repair kits include 2 pins, 2 washers and 2 clips

Description	Product No.
For Colt and Pony	PK-500
For Stallion and Shetland	PK-600



Pediatric™
Thermoplastic



OTS - Integrated Ankle Joints

- Thermoformable for cosmetic reasons
- The power of a metal ankle yet unobtrusive
- Dorsiflexion and/or plantar flexion assist
- Nickel plated for corrosion resistance
- Includes all mounting hardware, stirrups and alignment fixture

Size	Product No.
Thermoformable Dorsiflexion Assist Ankle	
Child	IACHDF-AL
Youth	IAYTHDF-AL
Thermoformable Double Action Ankle	
Child Small	IACHDA-AL
Youth Medium	IAYTHDA-AL
Thermoformable Adjustable Range-of-Motion Ankle	
Small	IASMARM-AL



Dorsiflexion Assist



Double Action



Adjustable Range-of-Motion

Split Tail Stirrups

- Unique “Y” shape of the split tail is perfectly suited for use in plastic NYUCB shoe insert configurations
- Choose from double action or dorsiflexion

Size	Product No.	
	Double Action	Dorsiflexion
Child	IARCHDAST	IARCHDFST
Youth	IARYTHDAST	IARYTHDFST

Double Action



Dorsiflexion



Solid Stirrups

- One head configuration
- Double action and adjustable range-of-motion use the same style head

Size	Dimensions	Product No.
Child-Small	6 ¹ / ₂ "	STWTDA6.5-CH
Child-Small	7 ¹ / ₄ "	STWTDA7.25-CH
Child-Small	8"	STWTDA8-CH



Precision O&P - Posterior Spring Assist with Adjustable Stop

- Two adjustable components for use in plastic articulated orthoses
- Vacuum molded into plastic without use of fasteners
- Made of durable high tech plastics & metals
- Usable in single & double pull articulated orthoses



Size	Spring Assist	Springs Only	
		Soft	Heavy Duty
Pediatric	PSA-100-P	PSA-P-SP	PSA-P-SPHD

Elite Line Posterior Adjustable Stop Component

- Compatible with all ankle joint components
- Incrementally adjustable to 25°
- Vacuum molded into plastic without use of fasteners
- Noise reduction bumper

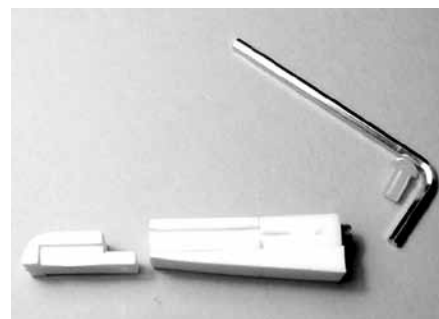

Size	Product No.
Pediatric	PAS-100-P
Pediatric Mini	PAS-100-PM

Elite Line of Dorsi Assist and Stop Components

- Compatible with all ankle joint components
- Mounted posterior midline
- Easily adjustable with 18° R.O.M
- Noise reduction bumper



Description	Product No.
Single Cable - Pediatric	DADS-100-P

Pediatric[®]
Thermoplastic



ANKLE JOINTS AND STIRRUPS

Becker Orthopedic - Model 2700 – Standard Flange with 2800 Head

- Standard flange stirrup with a 2800 series head configuration
- “Youth” size stirrup tongues measure 2⁴/₅”

Size	Length	Product No.
Youth	6 ³ / ₄ ”	2700-B6.75
Youth	7 ¹ / ₂ ”	2700-B7.5
Youth	8 ¹ / ₄ ”	2700-B8.25
Youth	9”	2700-B9



Model 2810 – Stirrup Insert

- Stamped one-piece design (no welds) with a generous radius at the attachment portion and upright extension interface

Size	X	Y	Thickness	Product No.
Child	2.36”	1 ⁴ / ₅ ”	³ / ₃₂ ”	2810-C1.8
Child	2.36”	2”	³ / ₃₂ ”	2810-C2.0
Child	2.36”	2.3”	³ / ₃₂ ”	2810-C2.3

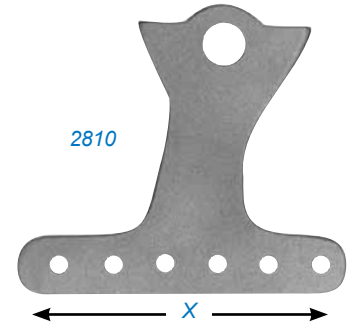

Double Action Y Stirrup Insert

- The “Y” shaped flanges are preferred by many orthotists

Size	X	Y	Thickness	Product No.
Child	3.36”	2.30”	³ / ₃₂ ”	2810-C-Y

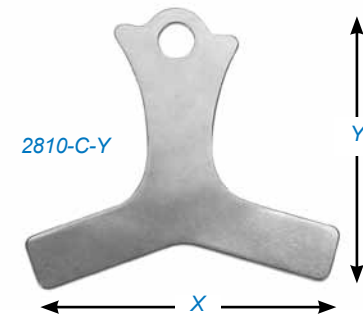

Model 2825 - Original Double Action Ankle Joints

- Joints are shipped complete with bushing, screw, ball bearings, springs, and hex set screws
- All “Child” joints have ⁵/₁₆” bushing hole
- Sold individually

Joint Size	Slot	Recess	Measures	Product No.
Child	³ / ₃₂ ”	¹ / ₂ ”	1 ³ / ₁₆ ” x 1 ¹ / ₂ ”	2825-C
Child 8*	¹ / ₈ ”	¹ / ₂ ”	1 ³ / ₁₆ ” x 1 ¹ / ₂ ”	2825-C8
*Compatible with “A” and “B” size stirrups				
*Includes 3870 Ring (Bushing Adapter Ring)				

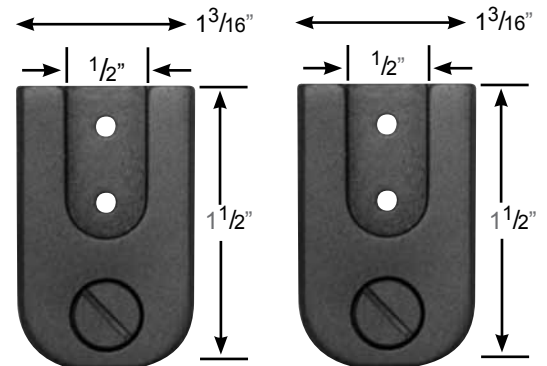

2825-C
Child size
304 stainless steel
Slot Depth: ³/₃₂”

2825-C8*
Child size
304 stainless steel
Slot Depth: ¹/₈”



Model 2835 – Double Action Ankle Joint with Attached Upright

- Round edge aluminum (square edge aluminum uprights available upon request); Sold individually

To Fit Stirrup Size	Upright Material	Upright Dimension	Product No.
Youth	Aluminum	1/4" x 3/4" x 15 ³ / ₁₆ "	W2835-A4
Youth	Aluminum	3/16" x 3/4" x 15 ³ / ₁₆ "	W2835-A6
Youth	Stainless Steel	3/16" x 3/4" x 15 ³ / ₁₆ "	W2835-A6S
Youth	Aluminum	1/4" x 5/8" x 15 ³ / ₁₆ "	2835-A4
Youth	Aluminum	3/16" x 5/8" x 15 ³ / ₁₆ "	2835-A6
Youth	Aluminum	1/8" x 5/8" x 15 ³ / ₁₆ "	2835-A8
Youth	Stainless Steel	3/16" x 5/8" x 15 ³ / ₁₆ "	2835-A6S
Youth	Stainless Steel	5/32" x 5/8" x 15 ³ / ₁₆ "	2835-A2S
Child	Aluminum	3/16" x 1/2" x 11"	2835-C6
Child	Aluminum	1/8" x 1/2" x 11"	2835-C8
Child	Stainless Steel	3/16" x 1/2" x 11"	2835-C6S
Child	Stainless Steel	1/8" x 1/2" x 11"	2835-C8S



2835

Model 2845 – One-Piece Aluminum Double Action Ankle Joint and Upright

- Offers lighter weight and improved strength
- Sold individually

Stirrup Size	Upright Dimensions	Product No.
Youth	3/16" x 5/8" x 15 ¹ / ₂ "	2845-A
Youth (w/pin)	3/16" x 5/8" x 15 ¹ / ₂ "	2845-AW/PIN
Child	3/16" x 1/2" x 8"	SC-2845-C



contoured
(side view)

Pediatric
Metal



ANKLE JOINTS AND STIRRUPS

2900 Series – Standard Flange Stirrup Only

- Recommended where a lightweight double action stirrup is required
- Youth: 1/8" stainless steel; two 3/8" bushing holes
- Child: 3/32" stainless steel; two 5/16" bushing holes
- "Youth" has 2 4/5" tongue; "Child" has 2 1/10" tongue

Size	Length	Product No.
Model 2900-B Youth Stirrup Only		
Youth	6 3/4"	2900-B6.75
Youth	7 1/2"	2900-B7.5
Youth	8 1/4"	2900-B8.25
Youth	9"	2900-B9
Model 2900-B Child Stirrup Only		
Child	4 1/2"	2900-C4.5
Child	5 1/4"	2900-C5.25
Child	6"	2900-C6
Child	6 3/4"	2900-C6.75



Model 2960 Original Double Action Split Stirrups

Size	Dimensions	Product No.	
		Slimline	Standard
Youth	1/8" x 3/4"	SL2960-B	2960-B
Child	3/32" x 1 1/16"	SL2960-C	2960-C



Model SLI/SLO-2825 – Slim Line Double Action Ankle Joints

- All units include bushing, screw, ball bearings, springs, and hex set screws; sold individually
- "Child" size joints = 5/16" bushing hole

Description	Inside Attachment	Outside Attachment
Aluminum	SLI-2825-C	SLO-2825-C



Model TISLI/TISLO-2825 – Titanium Slim Line Double Action Ankle Joints - Child

- The upright attaches to either the inside or outside
- This joint is used with child's slim line stirrups
- 1 3/4" over all height, 1 3/16" over all width; 5/16" bushing

Description	Inside Attachment	Outside Attachment
Titanium	TISLI-2825-C	TISLO-2825-C



Model SLI/SLO-2835 – Slim Line Double Action Ankle Joint with Attached Upright

- Modular ankle joint with upright attached
- Sold individually

Inside Recess	Upright Dimensions	Outside Recess
Stainless Steel Joints with Aluminum Uprights		
SLI-2835-C6	3/16" x 1/2" x 11"	SLO-2835-C6
SLI-2835-C8	1/8" x 1/2" x 11"	SLO-2835-C8
Stainless Steel Joints with Stainless Steel Uprights		
SLI-2835-C6S	3/16" x 1/2" x 11"	SLO-2835-C6S
SLI-2835-C8S	1/8" x 1/2" x 11"	SLO-2835-C8S
Titanium Joints with Aluminum Uprights		
TISLI-2835-C6	3/16" x 1/2" x 11"	TISLO-2835-C6
TISLI-2835-C8	1/8" x 1/2" x 11"	TISLO-2835-C8
Titanium Joints with Stainless Steel Uprights		
TISLI-2835-C6S	3/16" x 1/2" x 11"	TISLO-2835-C6S
TISLI-2835-C8S	1/8" x 1/2" x 11"	TISLO-2835-C8S

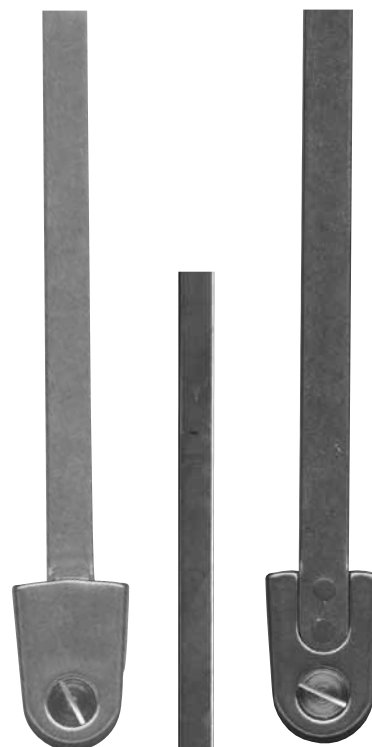

SLI-2835

SLO-2835

SL2845-A

Model SL2845-A – Slim Line One-Piece Aluminum Double Action Ankle Joint and Upright

- Sold individually, with or without pin
- Fits youth stirrup size
- Upright dimension: 3/16" x 5/8" x 14"

Description	Product No.
Slim Line Ankle Joint (without pin)	SL2845-A
Slim Line Ankle Joint (with pin)	SL2845-A W/PIN

Model M3025 – Standard Action Modular Ankle Joint

- Available in "Youth" size

Stirrup Size	Recess	Product No.
Youth	5/8"	M3025-B



Pediatric
Metal



Model 3035 – Standard Action Ankle Joint with Attached Upright

- Sold individually

Stirrup Size	Upright Material	Upright Dimension	Product No.
Youth	Aluminum	1/4" x 5/8" x 15 1/8"	3035-B4
Youth	Aluminum	3/16" x 5/8" x 15 1/8"	3035-B6
Youth	Aluminum	1/8" x 5/8" x 15 1/8"	3035-B8
Youth	Stainless Steel	3/16" x 5/8" x 15 1/8"	3035-B6S
Youth	Stainless Steel	5/32" x 5/8" x 15 1/8"	3035-B2S
Child	Aluminum	3/16" x 1/2" x 11"	3035-C6
Child	Aluminum	1/8" x 1/2" x 11"	3035-C8*
Child	Stainless Steel	3/16" x 1/2" x 11"	3035-C6S
Child	Stainless Steel	1/8" x 1/2" x 11"	3035-C8S*
Child	Stainless Steel	1/8" x 1/2" x 11"	3035-I8S**
*Model I8S upright is welded on			
**Model C*, C8S, and I*S come equipped with 3025-C ankle joint			



3035

Model 3045 – One Piece Aluminum Standard Action Ankle Joint and Upright

- Machined from 7075-T6 aluminum bar; Sold individually

Stirrup Size	Upright Dimensions	Product No.
Youth	3/16" x 5/8" x 16"	3045-B
Child	3/16" x 1/2" x 7 7/8"	3045-C



3045



Dorsiflexion Assist

3200 Series – Standard Flange Stirrup Only

- Designed to allow a limited amount of plantarflexion in addition to dorsiflexion assist
- Youth: 1/8" stainless steel; two 3/8" bushing holes
- Child: 3/32" stainless steel; two 5/16" bushing holes

Size	Length	Product No.
Model 3200-B Youth Stirrup Only 2.8" tongue		
Youth	6 ³ / ₄ "	3200-B6.75
Youth	7 ¹ / ₂ "	3200-B7.5
Youth	8 ¹ / ₄ "	3200-B8.25
Youth	9"	3200-B9
Model 3200-C Child Stirrup Only 2.1" tongue		
Child	4 ¹ / ₂ "	3200-C4.5
Child	5 ¹ / ₄ "	3200-C5.25
Child	6"	3200-C6
Child	6 ³ / ₄ "	3200-C6.75



3225 Series – Dorsiflexion Assist Ankle Joint Units

- Made from 303 stainless steel
- "B" Youth dorsiflexion assist ankle joint with 3/8" bushing hole and 1/8" slot, accepts 5/8" uprights
- "C" Child dorsiflexion assist ankle joint with 5/16" bushing hole and 3/32" slot, accepts 1/2" uprights
- "C8" Child size dorsiflexion assist ankle joint with 5/16" bushing hole and 1/8" slot; Used with "B" size stirrups and 3870 bushing adapter ring

Side	Product No.		
	"B"	"C"	"C8"
Left	3225-BL	3225-CL	3225-C8L
Right	3225-BR	3225-CR	3225-C8R
Pair	3225-B-P	3225-CP	3225-C8P

Model 3225-B

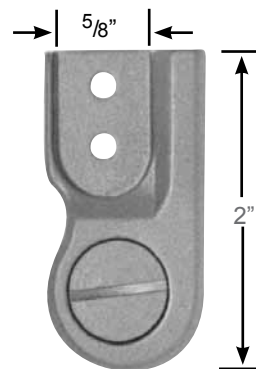

Model 3225-C

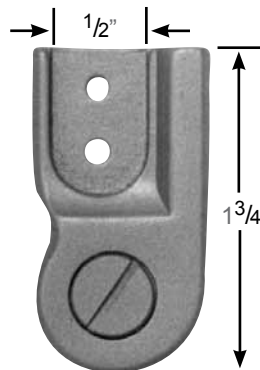

Model 3225-C8

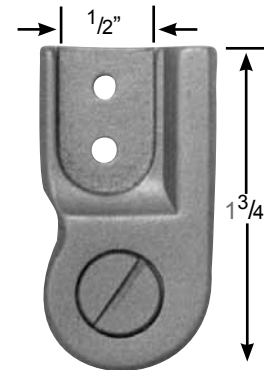

Pediatric
Metal



ANKLE JOINTS AND STIRRUPS

Model 3235 – Dorsiflexion Assist Ankle Joint with Attached Upright

Joint Size	Upright Material	Upright Dimensions	Pair	Product No.	
				Left	Right
Youth	Round Edge Aluminum	1/4" x 5/8" x 15 1/8"	—	3235-B4-L	3235-B4-R
Youth	Round Edge Aluminum	3/16" x 5/8" x 15 1/8"	3235-B6-P	3235-B6-L	3235-B6-R
Youth	Round Edge Aluminum	1/8" x 5/8" x 15 1/8"	—	3235-B8-L	3235-B8-R
Youth	Stainless Steel	3/16" x 5/8" x 15 1/8"	—	3235-B6S-L	3235-B6S-R
Youth	Stainless Steel	5/32" x 5/8" x 15 1/8"	—	3235-B2S-L	3235-B2S-R
Child	Round Edge Aluminum	3/16" x 1/2" x 11"	—	3235-C6-L	3235-C6-R
Child	Round Edge Aluminum	1/8" x 1/2" x 11"	—	3235-C8-L	3235-C8-R
Child	Stainless Steel	3/16" x 1/2" x 11"	—	3235-C6S-L	3235-C6S-R
Child	Stainless Steel	1/8" x 1/2" x 11"	—	3235-C8S-L	3235-C8S-R

Model C8 and C8S come equipped with 3225-C ankle joint



Model 3245 – One-Piece Aluminum Dorsiflexion Assist Ankle Joint and Upright

- This model is made from drop-forged aluminum
- One-piece construction is lightweight without sacrificing strength

Size	Dimension	Left	Product No.		Pair
			Right	Pair	
Youth	3/16" x 5/8" x 16 1/2"	3245-AL	3245-AR	3245-AP	
Child	3/16" x 1/2" x 10 1/2"	3245-CL	3245-CR	3245-CP	



Model 3260 – Dorsiflexion Assist Split Stirrup Upright Only

Size	Upright Dimensions	Product No.
Youth	1/8" x 3/4"	3260-B
Child	3/32" x 1 1/16"	3260-C



Model 3400 – Split Stirrup Caliper Plate

- Youth caliper plate made from .090" stainless steel
Child plate made from .075" stainless steel
- Youth: 1/8" x 3/4" channel dimension, 2 7/8" wide, 3 1/8" tongue
Child: 3/32" x 1 1/16" channel dimension, 2 3/8" wide, 2 1/2" tongue

Size	Left	Product No.	
		Right	Pair
Youth	3400-BL	3400-BR	3400-BP
Child	3400-CL	3400-CR	3400-CP



3400

Model 3400-X – Wide Flange Split Stirrup Caliper Plate

- Youth wide flange plate made from .090" stainless steel
- Youth 1/8" x 3/4" channel dimension, 3 3/8" wide, 6 7/8" tongue

Size	Left	Product No.	
		Right	Pair
Youth	3400-XBL	3400-XBR	3400-XBP



3400-X

Trulife - Upright with Ankle Joint for Toe Lift (POPE)

- Sold individually
- Single upright

Size	Metal	Product No.	
		Left	Right
Infant	Aluminum	018007	018012
Child	Aluminum	018041	018046



Pediatric
Metal

Extension Upright with Ankle Joint for Toe Lift (POPE)

- Sold individually

Size	Metal	Product No.	
		Left	Right
Child	3/16" x 5/8" x 9"	023001	023006



ANKLE JOINTS AND STIRRUPS

Extension Upright with Ankle Joint for Limited and Free Motion (POPE)

- Sold individually
- Infant bar dimensions include ankle joint

Size	Bar Dimensions	Product No.	
		Limited Motion	Free Motion
Child	$3/16"$ x $5/8"$ x $9"$	023021	023031



Modular Ankle Joint Head: Limited and Free Motion (POPE)

- Designed to be riveted to long or short leg uprights
- Child bar channel: $7/16"$
- Sold individually

Size	Product No.	
	Limited Motion	Free Motion
Child	020001	020009



Select Ankle Joint Kit

- Includes the medial and lateral side for 1 leg
- 1 kit per leg is needed

Description	Measurements	Product No.
Pediatric, Aluminum	$17/8"$ x $1"$ x $1/4"$	A224000001



Standard Short Tongue Solid Stirrups

- Height to medial malleolus
 - Sole thickness + Heel width = Stirrup length
- Available in toe lift, limited or free motion, and double action

Size	6"	7"	8"	$8^{3/4}"$	$9^{1/2}"$	$10^{1/4}"$	11"
Toe Lift							
Infant	035009	035011	035014	—	—	—	—
Child	035010	035012	035015	035018	035021	—	—
Limited and Free Motion							
Infant	035027	035030	035033	—	—	—	—
Child	035029	035031	035034	—	035040	—	—
Double Action							
Infant	035057	035058	035060	—	—	—	—



Toe Lift

Limited/Free Motion

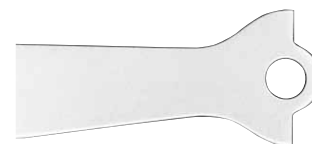

Double Action



Stainless Steel Caliper Foot Plate Only (POPE)

- 1/8" X 7/8"

Size	Product No.	
	Left	Right
Child	038022	038023



Modular Double Action Joints for Long Leg Brace

- Sold individually
- Stainless steel with positioning screws
- Infant, 1/2" bar channel

Product No. 020033



Upright with Ankle Joint for Limited and Free Motion (POPE)

- Single upright
- Sold individually

Description	Metal	Product No.		
		Infant	Child	Adult
Limited motion	Aluminum	018113	018130	018147
Free motion	Aluminum	018162	018173	018184



Infant's Aluminum Drop Lock Brace

- Upper Section 8" - Lower Section 11"
- 3/16" x 1/2"
- Sold as pair

Product No. 0003120010

Drop Lock NPJ (Non-Protrusion Joint) Stainless Steel Long Leg

- 1/8" x 1/2"
- Sold as pair
- Upper section 8" lower section 11"

Product No. O229000051



Pediatric
Metal



Becker Orthopedic - Model 1001 – Ring Lock Knee Joint

- Recommended for large patients and patients with knee flexion contractures, both of which increase the forces on the locking mechanism; ischial weight bearing and perthes orthoses
- NOTE: Do not remove medial or lateral rings; cannot be contoured

Joint Size	Upright Dimensions	Aluminum Uprights		SS Uprights
		Round Edge	Square Edge	Round Edge
Youth	1/4" x 5/8"	1001-B4	1001-B4T	—
Youth	3/16" x 5/8"	1001-B6	1001-B6T	1001-B6S
Youth	5/32" x 5/8"	—	—	1001-B2S
Child	3/16" x 1/2"	1001-C6	1001-C6T	1001-C6S
Child	1/8" x 1/2"	1001-C8	1001-C8T	1001-C8S



Model 1002 – Modified Ring Lock Knee Joint

- Eliminates the sharp protrusion of standard ring locks in the flexed position
- Infant size joints have no lower joint units: the distal upright is machined to fit into the upper joint unit
- Available with contoured lower joints upon request
- Note: Do not remove medial or lateral rings

Joint Size	Upright Dimensions	Aluminum Uprights		SS Uprights
		Round Edge	Square Edge	Round Edge
Youth	5/32" x 5/8"	—	—	1002-B2S
Youth	3/16" x 5/8"	1002-B6	1002-B6T	1002-B6S
Youth	1/4" x 5/8"	1002-B4	1002-B4T	—
Child	3/16" x 1/2"	1002-C6	1002-C6T	1002-C6S
Child	1/8" x 1/2"	1002-C8	1002-C8T	1002-C8S
Infant	1/8" x 1/2"	1002-I8	1002-I8T	1002-I8S
Infant	1/8" x 1/2"	—	—	1002-IIS



To order with contoured lower joints:
Add "B" for medial and lateral contours.
Add "R" for right medial contours.
Add "L" for left medial contours.

Model 1003 – Automatic Spring Lever Knee Joint

- Spring loaded lever system which automatically engages the locking device when the patient fully extends leg
- Since the lock may be disengaged with one hand and engages automatically, it is highly recommended for patients with impaired hand function
- Available with contoured lower joints upon request (specify left, right or both for contoured joints)

Joint Size	Upright Dimensions	Aluminum Uprights		SS Uprights
		Round Edge	Square Edge	Round Edge
Youth	1/4" x 5/8"	1003-B4	1003-B4T	—
Youth	3/16" x 5/8"	1003-B6	1003-B6T	1003-B6S

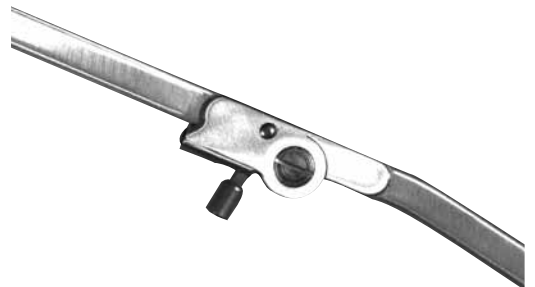

Model 1004 – Posterior Offset Lever Lock Knee Joint

- Designed with the axis of motion located posteriorly to the upright bars
- Ideally suited for patients with impaired hand function
- Optional Urethane Assist Strap can be used to automatically engage lever locks
- Available with contoured lower joints upon request (specify left, right or both for contoured joints)

Joint Size	Upright Dimensions	Aluminum Uprights		SS Uprights
		Round Edge	Square Edge	Round Edge
Youth	1/4" x 5/8"	1004-B4	1004-B4T	—
Youth	3/16" x 5/8"	1004-B6	1004-B6T	1004-B6S

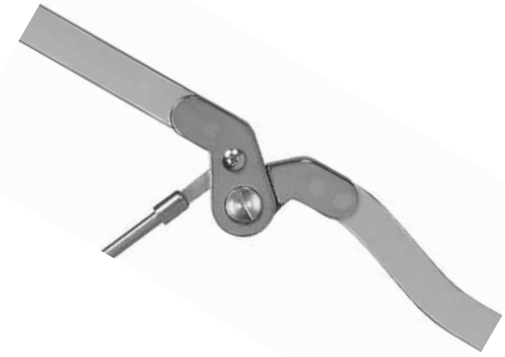

To order with contoured lower joints:
Add "B" for medial and lateral contours.
Add "R" for right medial contours.
Add "L" for left medial contours.

Model 1005 – Free Motion Knee Joint

- Free motion knee joint has a 180° extension stop
- Precision machined midsections move smoothly through the entire range-of-motion
- Cannot be contoured

Joint Size	Upright Dimensions	Aluminum Uprights		SS Uprights
		Round Edge	Square Edge	Round Edge
Youth	3/16" x 5/8"	1005-B6	1005-B6T	1005-B6S
Youth	5/32" x 5/8"	—	—	1005-B2S
Child	3/16" x 1/2"	1005-C6	1005-C6T	1005-C6S
Child	1/8" x 1/2"	1005-C8	1005-C8T	1005-C8S

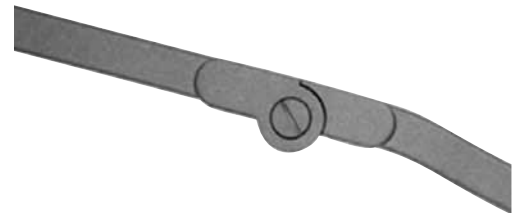

Model 1006 – Adjustable Extension Ring Lock Knee Joint

- Increase or decrease the extension angle by 6° intervals
- Recommended for patients with knee flexion contractures
- Do not remove medial or lateral rings; cannot be contoured
- Child size is manufactured differently, showing midsection

Joint Size	Upright Dimensions	Round Edge Uprights	
		Aluminum	Stainless Steel
Youth	1/4" x 5/8"	1006-B4	—
Youth	3/16" x 5/8"	1006-B6	1006-B6S
Youth	5/32" x 5/8"	—	1006-B2S
Child	3/16" x 1/2"	1006-C6	1006-C6S
Child	1/8" x 1/2"	1006-C8	1006-C8S

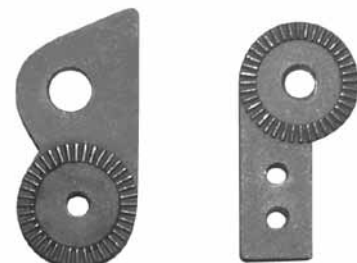

2L (left) 2R (right) 3L (left) 3R (right)

1006-C

Pediatric
Metal



Model 1007 – Adjustable Extension Automatic Spring Lever Knee Joint

- Increase or decrease the extension stop with the serrated disc
- Unique feature of Model 1007 is the spring loaded lever lock to lock the joint at full extension
- Effective for patients with limited hand function
- Round edge uprights; cannot be contoured

Joint Size	Upright Dimensions	Aluminum Uprights	Stainless Steel Uprights
Youth	1/4" x 5/8"	1007-B4	—
Youth	3/16" x 5/8"	1007-B6	1007-B6S

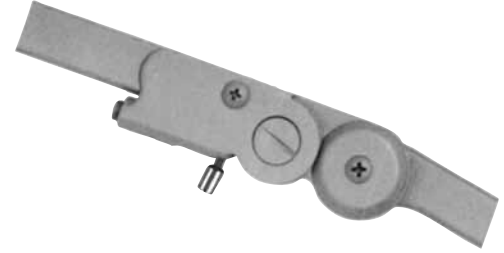

Model 1008 – Posterior Offset Free Motion Knee Joint

- Developed to create a knee joint with the axis of motion located posteriorly to the upright bars
- Fully interchangeable with the posterior offset ring lock (Model 1012), therefore easily converted to a ring lock by ordering the Model 1012 rings
- Infant size joints have no lower joint unit: the distal upright is machined to fit into the upper joint unit
- Available with contoured lower joints upon request (Youth sizes only)

Joint Size	Upright Dimensions	Aluminum Uprights		SS Uprights
		Round Edge	Square Edge	Round Edge
Youth	1/4" x 5/8"	1008-B4	1008-B4T	—
Youth	3/16" x 5/8"	1008-B6	1008-B6T	1008-B6S
Youth	3/16" x 1/2"	1008-C6	1008-C6T	1008-C6S
Child	1/8" x 1/2"	1008-C8	1008-C8T	1008-C8S
Infant	1/8" x 1/2"	1008-I8	1008-I8T	1008-I8S

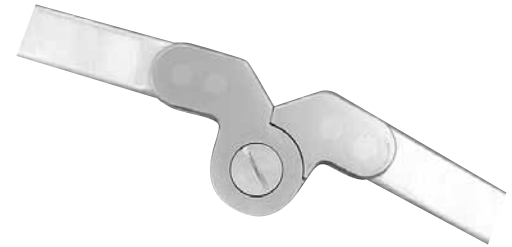

To order with contoured lower joints:
Add "B" for medial and lateral contours.
Add "R" for right medial contours.
Add "L" for left medial contours.

Model 1009 – Polycentric Free Motion Knee Joint

- Approximates the knee's anatomical movement more closely
- Stainless steel midsections for increased durability and strength
- Cannot be contoured

Joint Size	Upright Dimensions	Aluminum Uprights		SS Uprights
		Round Edge	Square Edge	Round Edge
Youth	3/16" x 5/8"	1009-B6	1009-B6T	1009-B6S
Child	3/16" x 1/2"	1009-C6	1009-C6T	1009-C6S
Child	1/8" x 1/2"	1009-C8	1009-C8T	1009-C8S



Model 1010 – Adjustable Extension/Flexion Ring Knee Joint

- Provides the orthotist with an extension stop in 6° intervals as well as providing an adjustable flexion stop in 19° intervals (Youth Joints) or 23.75° intervals (Child)
- Do not remove medial or lateral ring; Do not use this joint unilaterally
- Cannot be contoured

Joint Size	Upright Dimensions	Aluminum Uprights Round Edge	SS Uprights Round Edge
Youth	1/4" x 5/8"	1010-B4	—
Youth	3/16" x 5/8"	1010-B6	1010-B6S
Child	3/16" x 1/2"	1010-C6	1010-C6S
Child	1/8" x 1/2"	1010-C8	1010-C8S



Model 1011 – Automatic Trigger Lock Knee Joint

- Essentially the same joint as the Model 1003 Automatic Spring Lever Lock; however, the lever is replaced with a locking tip which is attached by cable to a trigger
- Trigger allows patient to disengage locks without bending over
- Locks will automatically engage when leg is extended
- Cannot be contoured

Joint Size	Upright Dimensions	Aluminum Uprights		SS Uprights
		Round Edge	Square Edge	Round Edge
Youth	1/4" x 5/8"	1011-B4	1011-B4T	—
Youth	3/16" x 5/8"	1011-B6	1011-B6T	1011-B6S



Model 1012 – Posterior Offset Ring Lock Knee Joint

- Axis motion is offset posteriorly from the upright bars, thereby closely approximating the movement of the anatomical knee
- Joint can be easily changed to free motion by removing the rings
- Infant size joints have no lower joint unit: the distal upright is machined to fit into the upper joint unit
- Available with contoured lower joints upon request

Joint Size	Upright Dimensions	Aluminum Uprights		SS Uprights
		Round Edge	Square Edge	Round Edge
Youth	1/4" x 5/8"	1012-B4	1012-B4T	—
Youth	3/16" x 5/8"	1012-B6	1012-B6T	1012-B6S
Child	3/16" x 1/2"	1012-C6	1012-C6T	1012-C6S
Child	1/8" x 1/2"	1012-C8	1012-C8T	1012-C8S
Infant	1/8" x 1/2"	1012-I8	1012-I8T	1012-I8S



To order with contoured lower joints:
Add "B" for medial and lateral contours.
Add "R" for right medial contours.
Add "L" for left medial contours.

Pediatric
Metal



Model 1014 – Ratchet Lock™ Knee Joint

- Designed to promote full knee extension by providing knee stability through incremental range of knee flexion
- Distinctive, anterior low-profile locking mechanism
- Joint features a secure, semi-automatic locking mechanism that can be quickly and easily disengaged
- Weight limits: Youth up to 120 lbs, Child up to 60 lbs
- Cannot be contoured

Uprights	Joint Size	Upright Dimensions	Product No.
Aluminum	Youth	3/16" x 5/8"	1014-B6
Aluminum	Child	3/16" x 1/2"	1014-C6
Stainless Steel	Youth	3/16" x 5/8"	1014-B6S
Stainless Steel	Child	3/16" x 1/2"	1014-C6S



Model S2001 – Assembled and Disassembled Ring Lock Knee Joint

- Stainless steel side plates are riveted on the proximal upright to form the upper joint unit
- Distal bar is machined to fit into the upper joint unit
- NOTE: Do not remove medial or lateral ring
- Model S2001 is assembled with bushing and screw; flexion set at 180°
- Model R2001 is disassembled with rivet and requires distal bar to be shaped

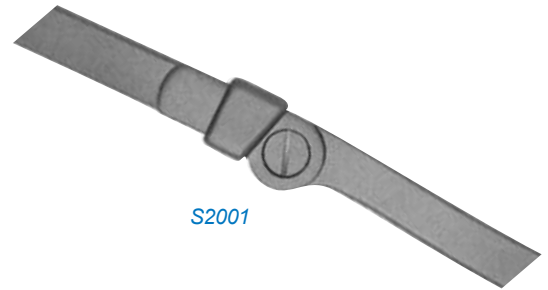

S2001

Joint Size	Upright Dimensions	Aluminum Round Edge w/Bushing & Screw	Aluminum Round Edge w/Joint Rivet	Stainless Steel w/Bushing & Screw	Stainless Steel w/Joint Rivet
Youth	1/4" x 5/8"	S2001-B4	R2001-B4	—	—
Youth	3/16" x 5/8"	S2001-B6	R2001-B6	S2001-B6S	R2001-B6S
Child	3/16" x 1/2"	S2001-C6	R2001-C6	S2001-C6S	R2001-C6S
Child	1/8" x 1/2"	S2001-C8	R2001-C8	S2001-C8S	R2001-C8S

Model S2005 – Assembled and Disassembled Free Motion Knee Joints

- Model S2005 is assembled with bushing and screw; flexion set at 180°
- Model R2005 is disassembled with rivet and requires distal bar to be shaped



S2005

Joint Size	Upright Dimensions	Aluminum Round Edge w/Bushing & Screw	Aluminum Round Edge w/Joint Rivet	Stainless Steel w/Bushing & Screw	Stainless Steel w/Joint Rivet
Youth	1/4" x 5/8"	S2005-B4	R2005-B4	—	—
Youth	3/16" x 5/8"	S2005-B6	R2005-B6	S2005-B6S	R2005-B6S
Child	3/16" x 1/2"	S2005-C6	R2005-C6	S2005-C6S	R2005-C6S
Child	1/8" x 1/2"	S2005-C8	R2005-C8	S2005-C8S	R2005-C8S



FullStride™ Kit with GX-Assist

- For individuals with significant weakness of hip musculature
- Available with GX-Assist option that incorporates a pneumatic spring on the lateral joint unit to assist in knee extension during the swing phase of gait
- Available in a 125N pneumatic spring (for standard application) or 175N (for high activity patients); also 75N
- To specify spring when ordering, replace ? with 125 or 175

Uprights	Joint Size	Upright Dimensions	Product No.	
			Left	Right
Aluminum	Youth	3/16" x 5/8"	9006-GX-B6-L-?	9006-GX-B6-R-?
Stainless Steel	Youth	3/16" x 5/8"	9006-GX-B6S-L-?	9006-GX-B6S-R-?



Fillauer - Cam Lock Knee Joint Assemblies with Screws

- Secure and long wearing
- Stainless steel joint with aluminum or stainless steel bars
- Cable release kit (023463)
- Sold as a pair

Description	Stainless Steel	Aluminum
Small Joint Head - 1/8" (3 mm) x 1/2" (13 mm) Bar		
Straight	023620SS	023620SA
Left Medial Contoured	023620SSL	023620SAL
Right Medial Contoured	023620SSR	023620SAR
Both Contoured	023620SSB	023620SAB
Medium Joint Head - 3/16" (5 mm) x 5/8" (16 mm) Bar		
Straight	023660MS	023660MA
Left Medial Contoured	023660MSL	023660MAL
Right Medial Contoured	023660MSR	023660MAR
Both Contoured	023660MSB	023660MAB
Large Joint Head - 3/16" (5 mm) x 3/4" (19 mm) Bar		
Straight	023660LS	023660LA
Left Medial Contoured	023660LSL	023660LAL
Right Medial Contoured	023660LSR	023660LAR
Both Contoured	023660LSB	023660LAB

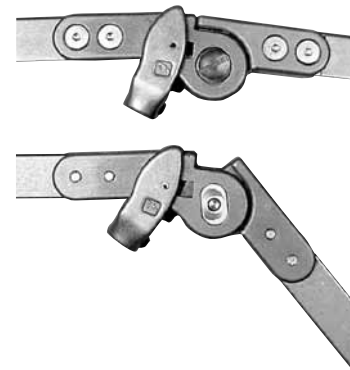
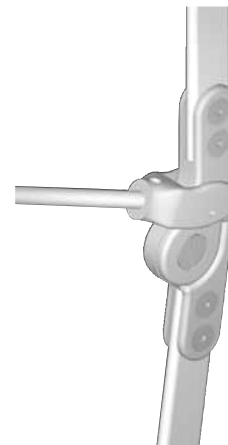

Pediatric
Metal



OTS - InterLock Orthotic Knee Joint

- Functions as drop lock, bail lock, or lever release
- Built in spring loaded "bail stop"; no drilling or setting ball retainers required

Size	Style	Product No.
3/16" x 1/2"	Straight	IL512KS
3/16" x 1/2"	Left Medial Contoured	IL512KL
3/16" x 1/2"	Right Medial Contoured	IL512KR



StepLock Orthotic Knee Joint

- The StepLock is entirely CNC machined to high tolerances
- CNC Machining, coupled with our bright nickel finish, produces a smooth feel and high-tech appearance
- It is modular and interchangeable with the Interlock
- Its unique "ratchet action" makes it ideal as a standing assist or for flexion contractures

Size	Style	Product No.
3/16" x 1/2"	Straight	SL512KS
3/16" x 1/2"	Left Medial Contoured	SL512KL
3/16" x 1/2"	Right Medial Contoured	SL512KR
3/16" x 1/2"	Double Contoured	SL512KB
Hip Joints		
3/16" x 1/2"		SL512H
Lever Release Kits		
for 512 only		LRK512 SM



Becker Orthopedic - Model 1020 – Ring Lock Hip Joint

- Recommended for large or extremely active patients
- All mid-sections and uprights are stainless steel
- Available with a straight proximal upright instead of a “T” bar; when ordering, add an “S” to the beginning of the product number
- Note: Do not remove rings



1020

Model 1022 – Modified Ring Lock Hip Joint

- No protrusions to catch or fray garments when the patient is in the seated position
- All mid-sections and uprights are stainless steel
- Available with a straight proximal upright instead of a “T” bar; when ordering, add an “S” to the beginning of the product number
- Note: Do not remove rings



1022

Joint Size	Upright Dimension	Side	Product No.	
			Standard	Modified
Youth	3/16" x 5/8"	Left	1020-BL	1022-BL
Youth	3/16" x 5/8"	Right	1020-BR	1022-BR
Youth	3/16" x 5/8"	Pair	1020-BP	1022-BP
Child	3/16" x 1/2"	Left	1020-CL	1022-CL
Child	3/16" x 1/2"	Right	1020-CR	1022-CR
Child	3/16" x 1/2"	Pair	1020-CP	1022-CP

Model 1022-I/1022-II Infant Modified Ring Lock Hip Joint

- The 1022 series has been specially designed with very small midsections for use as an infant hip joint
- The overall midsection length on Model 1022-I is 1³/₅"
- The Model 1022-II is even smaller with a overall length of 1¹/₄"
- The proximal and distal uprights are stainless steel

Side	Upright Dimensions	Product No.	
		Infant	Tiny Tot
Left	1/8" x 1/2"	1022-I8L	1022-I8L
Right	1/8" x 1/2"	1022-I8R	1022-I8R
Pair	1/8" x 1/2"	1022-I8P	1022-I8P



1022-I



1022-II

Pediatric
Metal



Model 1025 – Free Motion Hip Joint with 180° Extension Stop

- All mid-sections and uprights are stainless steel
- Straight proximal upright is ideal for attaching a spinal orthosis
- Available with a straight proximal upright instead of a “T” bar; when ordering, add an “S” to the beginning of the product number

Joint Size	Upright Dimension	Side	Product No.
Youth	3/16" x 5/8"	Left	1025-BL
Youth	3/16" x 5/8"	Right	1025-BR
Youth	3/16" x 5/8"	Pair	1025-BP
Child	3/16" x 1/2"	Left	1025-CL
Child	3/16" x 1/2"	Right	1025-CR
Child	3/16" x 1/2"	Pair	1025-CP



Model 2020 – Ring Lock Hip Joint

- Standard ring lock hip joint
- Manufactured with aluminum or stainless steel proximal and distal uprights; Joint side plates are stainless steel



Model 2020

Model 2025 – Free Motion Hip Joint

- Free motion hip joint with a 180° extension stop
- Manufactured with aluminum or stainless steel proximal and distal uprights; Joint side plates are stainless steel



Model 2025

Model 2032 – Two Position Ring Lock Hip Joint

- Designed to lock at 180° and at 90°
- Suggested for patients who need additional support to sit upright
- Manufactured with aluminum or stainless steel proximal and distal uprights; Joint side plates are stainless steel



Model 2032

Joint Size	Upright Dimension	Side	Aluminum			Stainless Steel		
			Ring Lock	Free Motion	Two Position	Ring Lock	Free Motion	Two Position
Youth	1/4" x 5/8"	Left	2020-B4L	2025-B4L	2032-B4L	—	—	—
Youth	1/4" x 5/8"	Right	2020-B4R	2025-B4R	2032-B4R	—	—	—
Youth	1/4" x 5/8"	Pair	2020-B4P	2025-B4P	2032-B4P	—	—	—
Youth	3/16" x 5/8"	Left	—	—	—	2020-B6SL	2025-B6SL	2032-B6SL
Youth	3/16" x 5/8"	Right	—	—	—	2020-B6SR	2025-B6SR	2032-B6SR
Youth	3/16" x 5/8"	Pair	—	—	—	2020-B6SP	2025-B6SP	2032-B6SP
Child	3/16" x 1/2"	Left	2020-C6L	2025-C6L	2032-C6L	2020-C6SL	2025-C6SL	2032-C6SL
Child	3/16" x 1/2"	Right	2020-C6R	2025-C6R	2032-C6R	2020-C6SR	2025-C6SR	2032-C6SR
Child	3/16" x 1/2"	Pair	2020-C6P	2025-C6P	2032-C6P	2020-C6SP	2025-C6SP	2032-C6SP
Child	1/8" x 1/2"	Left	2020-C8L	2025-C8L	—	2020-C8SL	2025-C8SL	—
Child	1/8" x 1/2"	Right	2020-C8R	2025-C8R	—	2020-C8SR	2025-C8SR	—
Child	1/8" x 1/2"	Pair	2020-C8P	2025-C8P	—	2020-C8SP	2025-C8SP	—



Model 400-1 – Flexible Torsion Cable

- Specify length from the end of one connector to the other, internal or external rotation, and right or left leg
- Sold individually



Model 400-1

Cable Diameter	Product No.
1/4"	400-1B
5/16"	400-1A
3/8"	400-1X

Model 400-2 – Hip Joint

- Sold individually



Model 400-2

Cable Diameter	Product No.
1/4"	400-2B
5/16"	400-2A
3/8"	400-2X

Model 400-4 – Stirrup

- Left, right, or pair



Model 400-4

Cable Diameter	Left	Product No.	
		Right	Pair
1/4"	400-4BL	400-4BR	400-4BP
5/16"	400-4AL	400-4AR	400-4AP
3/8"	400-4XL	400-4XR	400-4XP

Model 400-6 – Thigh Attachment

- Sold individually, left or right



Model 400-6

Cable Diameter	Product No.
1/4"	400-6B
5/16"	400-6A
3/8"	400-6X

Pediatric
Metal



Model 400-7 – AFO Attachment

- Sold individually

Cable Diameter	Product No.	
	Left	Right
1/4"	400-7BL	400-7BR
5/16"	400-7AL	400-7AR
3/8"	400-7XL	400-7XR



Model 400-7

Model 400-8 – Pelvic Band

- May be used with A, B and X sizes of hip joints
- Available circumference sizes: 15-30
- Replace ? with pelvic circumference

Product No. **400-8-?**

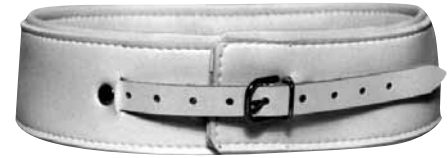

Model 400-9 – Pelvic Band with Hip Joints Attached

- Specify pelvic circumference
- Diameter 5/16" and 3/8" available in circumference sizes: 15-30
- Replace ? with pelvic circumference

Cable Diameter	Product No.
1/4"	400-9B
5/16"	400-9A-?
3/8"	400-9X-?



Answer 2 Hi-Tops (Unisex)

- Symmetrical straight last
- Added depth (³/₈") deeper than conventional straight last shoes
- Better accommodation for orthotics, AFO's and internal modifications
- Long medial counter to provide support and stability
- Three removable inserts for flexible fitting
- Whole and half sizes: 4-11¹/₂; Replace ? with size
- Available in White or Black

Description	Product No.	
	Black	White
Medium Width	299-1?M	299-3?M
Wide Width	299-1?W	299-3?W



Answer 2 Speed Lacer (Unisex)

- Lace up entry and hook and loop closure
- Provides stability and accommodates an AFO or KAFO
- High, wide extra firm toe box provides added comfort and limits toe pressure
- Whole and half sizes: 11-6; Replace ? with size
- Available in White or Black

Description	Product No.	
	Black	White
Medium Width	230-1?M	231-3?M
Wide Width	230-1?W	231-3?W



Answer 2 Youth Girl's Lace Walking Shoes

- Symmetrical straight last and cut line for easy sole modification
- Added depth to accommodate AFO's and foot orthotics
- Added width at the toe and extra girth at the ankle
- Extended medial counters provide support and stability
- Three removable inserts for flexible fitting
- Available sizes: 11-6; Replace ? with size
- Available in White with Pink

Description	Product No.	
	Replacement Inserts	Shoes
Medium Width	307-?M	224-3?M
Wide Width	307-?W	224-3?W



Pediatric
Shoes



Answer 2 Youth Boy's Lace Walking Shoes

- Symmetrical straight last
- Added depth to accommodate AFO's and foot orthotics
- Added width at the toe and extra girth at the ankle
- Extended medial counters provide support and stability
- Three removable inserts for flexible fitting
- Symmetrical cut line for easy sole modification
- Available sizes: 11-6; Replace ? with size
- Available in White with Blue



Description	Product No.	
	Replacement Inserts	Shoes
Medium Width	307-?M	223-3?M
Wide Width	307-?W	223-3?W

Answer 2 Boy's Infant & Child Shoes

- Symmetrical straight last
- Added depth ($\frac{3}{8}$ ") deeper than conventional straight last shoes
- Better accommodation for orthotics, AFO's and internal modifications
- Long medial counter to provide support and stability
- Whole and half sizes 4-11 $\frac{1}{2}$
- Three removable inserts for flexible fitting
- Whole and half sizes: 4-11 $\frac{1}{2}$; Replace ? with size
- Available in White with Blue



Description	Product No.	
	Replacement Inserts	Shoes
Medium Width	306-?M	225-3?M
Wide Width	306-?W	225-3?W

Answer 2 Girl's Infant & Child Shoes

- Symmetrical straight last
- Added depth ($\frac{3}{8}$ ") deeper than conventional straight last shoes
- Better accommodation for orthotics, AFO's and internal modifications
- Long medial counter to provide support and stability
- Three removable inserts for flexible fitting
- Whole and half sizes: 4-11 $\frac{1}{2}$; Replace ? with size
- Available in White with Pink



Description	Product No.	
	Replacement Inserts	Shoes
Medium Width	306-?M	222-3?M
Wide Width	306-?W	222-3?W



Answer 2 Youth Girl's/Boy's Lace Walking Shoes (Unisex)

- Symmetrical straight last and cut line for easy sole modification
- Added depth to accommodate AFO's and foot orthotics
- Added width at the toe and extra girth at the ankle
- Extended medial counters provide support and stability
- Three removable inserts for flexible fitting
- Available sizes: 11-6; Replace ? with size
- Available in White with Silver



Description	Product No.	
	Replacement Inserts	Shoes
Medium Width	307-?M	226-3?M
Wide Width	307-?W	226-3?W

Answer 2 Youth Girl's Mary Jane

- Symmetrical straight last and cut line for easy sole modifications
- Added width at the toe and extra girth at the ankle
- Extra length hook and loop strap to fit higher instep
- 3 removable inserts for flexible fitting
- Long medial counter to provide support and stability
- Added depth (8 mm or 5/16") deeper than conventional straight last shoes
- Available sizes: 11-6; Replace ? with size
- Available in Black



Description	Product No.
Medium Width	227-1?M
Wide Width	227-1?W
Extra Wide Width	227-1?XW

Answer 2 Youth Oxford Unisex Shoes

- Symmetrical straight last and cut line for easy sole modifications
- Added width at the toe and extra girth at the ankle
- Extended bigger throat for easy entry
- 3 removable inserts for flexible fitting
- Whole and half sizes
- Long medial counter to provide support and stability
- Added depth (8 mm or 5/16") deeper than conventional straight last shoes
- Available sizes: 11-6; Replace ? with size
- Available in Black



Description	Product No.
Medium Width	228-1?M
Wide Width	228-1?W
Extra Wide Width	228-1?XW

Pediatric
Shoes



Darco - Pediatric Slimline Cast Boot

- Square toe design acts as a protective bumper and gives the patient more room to accommodate larger casts and bandages
- Stiff sole and long-wearing polyester and EVA upper
- Hook and loop closures; Higher ankle strap adds stability
- Available in Navy

Size	Children's Shoe Size	Product No.
Small	5-7 ¹ / ₂	SLO1NP
Medium	8-11 ¹ / ₂	SLO2NP
Large	12-1 ¹ / ₂	SLO3NP



Med-Surg™ Shoe

- Square-toe design acts as a bumper to protect the toes when k-wires are present and provides better left/right fit
- MetaShank™ protection provides more rigid control under the metatarsal heads
- Strapless closure eliminates buckle pressure on the forefoot and can expand to accommodate dressing up to 17 inches in circumference
- Children's shoe size: 12-1

Product No. **MQPB**



Original Med-Surg™ Shoe

- Patented metatarsal shank provides superior control of forefoot motion to ensure post operative healing remains undisturbed
- Reinforced padded heel grips the foot and reduces slippage
- Breathable mesh upper light weight material allows for proper ventilation and conforms to bony abnormalities
- Children's shoe size: 12-1

Product No. **MSPN**



Langer - GloboTec Junior

- Prefabricated orthotic suited for the pediatric patient
- Deep heel seat to improve stability and motion control
- Base made from 1.5 mm special thermoplastic material, making it extremely space saving inside the shoe
- Heat moldable at 250 degrees; Shell easily ground

Description	Size	Product No.
Child	5/6	70205
Child	7/7 ¹ / ₂	70220
Child	8/9	70230
Child	10/11	70240
Child	12/13	70250
Child	13 ¹ / ₂ /1	70260
Youth	2/3	70270
Jr. Adult	4/5	70280



Anatomical Concepts - Knee Management Orthosis

- For an adjustable range of stabilization of the knee in the sagittal plane as the patient's conditions warrant
- Pre- and post-operative management of bony and soft tissue injuries
- For immediate prophylactic protection at end range until treatment plans are finalized
- Flexion up to 110°

Indications: Application following hamstring releases; Ligament repairs; Total knee arthroplasty; Chronic systemic conditions



Description	Height Adjustment	KMO Product No.	KMO with Varum/Valgum Adjustment
Pediatric	12 ³ / ₄ "-17"	850	860
		Stabilizing Shells	Replacement Liners
Pediatric		P85	L85
Size	Length	Calf Circum.	Thigh Circum.
Sizing Chart for KMO			
Pediatric	12 ¹ / ₂ "-16 ¹ / ₂ "	8"-15"	12"-20"
Sizing Chart for KMO with Varum/Valgum Adjustment			
Pediatric	13 ¹ / ₂ "-17 ¹ / ₂ "	8"-15"	12"-20"

DeRoyal - Pro-Glide® Knee

- Dynamic splint offers flexion and extension assist in one unit
- Aircraft quality aluminum frame is strong yet lightweight
- Tension lockout at 0°, 45°, and 90°
- Universal left or right

Indications: Joint stiffness; ROM limitations; Soft tissue contractures

Size	Thigh Circum.	Calf Circum.	Replacement Softgoods	Product No.
Ped. Medium	up to 14"	8"-10 ¹ / ₂ "	4107CK	4107C
Ped. Large	14"+	10 ¹ / ₂ "-14"	4107DK	4107D



Pediatric
Knee Orthoses



Lenjoy - Goniometer Knee Orthosis

- Treats non-fixed contractures of the knee
- Geared to increasing extension; works in the same way as serial casting, gradually adjusting the degrees of extension
- Well padded, minimizing skin breakdown
- Easily positioned in 10° increments



Size	Knee To Ankle	Knee to Thigh	Total Length	Below Thigh Circum.	Above Calf Circum.	Product No.
Small	3 ³ / ₄ "	3 ³ / ₄ "	7 ¹ / ₂ "	5"-10"	4"-6"	PGK-101-S
Medium	4 ¹ / ₂ "	4 ¹ / ₂ "	9"	6"-11"	5"-10"	PGK-101-M
Large	5 ¹ / ₄ "	5 ¹ / ₄ "	10 ¹ / ₂ "	10"-14"	8"-13"	PGK-101-L

Palumbo - Pediatric Palumbo Tracker (not pictured)

- Utilizes a patella mechanism wherein the lateral bracing is allowed to float so as to maintain the most effective position with respect to the patella during flexion of the knee
- The lateral pad control is constructed of visco-elastic material to better conform and adjust the floating of the brace
- The positioned elastic insert in the patella strap between the anchor and pad allows for the "floating" action which reposition the pad according to the full physiologic range of motion to the knee
- Tracker with adjustable anchor placement improves tension control to accommodate a wider range of patient requirements

Size	Inches at Mid Knee	Beige	Product No.	
			Black	Blue
Small	6"-7"	P108SBEIGE	P108SBLACK	P108SBLUE
Medium	7"-8"	P108MBEIGE	P108MBLACK	P108MBLUE
Large	8"-9"	P108LBEIGE	P108LBLACK	P108LBLUE
X-Large	9"-10"	P108XLBEIGE	P108XLBLACK	P108XLBLUE
2X-Large	10"-11"	P108XXLBEIGE	P108XXLBLACK	P108XXLBLUE



RCAI - Post Operative Pin® Knee Brace

- Lightweight, drop pin hinge controls flexion and extension in 7.5° increments
- Allows for free range-of-motion and can be locked in full extension

Indications: Post operative immobilization and protected range-of-motion associated with ACL, PCL, MCL, and LCL surgeries

Size	Length	Maximum Thigh	Maximum Calf Circum.	Product No.
Pediatric	13"	19"	13 ¹ / ₂ "	77POP-P



Ratchet POP Knee Brace

- Flexion/extension ROM control in 5° increments
- Angle of limb can be extended in 10° increments from 0°-60° without using tools
- Knee cap provides 3-point pressure leverage

Indications: Post-surgical ROM limitations; Ligament repairs; Instability and soft tissue contractures

Size	Thigh Circumference (4" above knee center)	Product No.
Pediatric	9"-12"	67RKPOP-P
Small	12"-15"	67RKPOP-S
Medium	15"-20"	67RKPOP-M
Large	20"-24"	67RKPOP-L



Premier Knee Orthosis

- Progressive static lock settings permit gradual increases in knee joint extension and positioning
- Lightweight nylon hinges can accommodate patients with zero to moderate tone and mild spasticity; thermoplastic cuffs
- Length: 12¹/₂", Child, Youth

Size	Measure Mid Thigh Circum.	Product No.	
		Premier KCO	Kodel
Child	10"-12"	27KCO-C	23KCO-C
Youth	12"-14"	27KCO-Y	23KCO-Y
Knee Cap (for use with Premier Knee Orthosis, Kodel)			
Size	Product No.		
Youth/Child	27KC-Y/C		
3-point pressure leverage			



Knee Cap

Pediatric
Knee Orthoses



Pediatric Hinged Knee Brace

- Provides support, compression and warmth for medial/lateral ligament instability, anterior/posterior cruciate instability, and patellar tendonitis and dislocation
- Lightweight bilateral metal hinges provide excellent medial and lateral knee support and allow full ROM with hyperextension stop
- Patellar cutout horseshoe-shaped felt buttress can be repositioned to support the medial or lateral condyle
- Upper and lower circumferential straps prevent brace migration



Size	Knee Circumference (measure knee center)	Product No.
Infant	7"-8"	550-HKB-I
Toddler	8"-9"	550-HKB-T
Child	9"-10"	550-HKB-C
Youth	10"-11"	550-HKB-Y
X-Small	11"-12"	550-HKB-ES

Wheaton™ Brace Co. - Pediatric Knee Immobilizer

- Soft, comfortable 1/8" thick laminated foam construction
- Removable stay assemblies for versatile medial and lateral positioning

Size	Size	Product No.
Infant	6"	CKN6
Toddler	9"	CKN9
Young Child	12"	CKN12
Child	14"	CKN14
Adolescent	16"	CKN16
Youth	18"	CKN18



Wheaton KAFO

- Consists of the Wheaton Brace AFO connected to a thermoplastic upper component (Knee extension, KO) with touch fasteners
- Upper component is designed to keep the knee flexed at 90° flexion
- When used with the lower component (AFO), it allows for torque correction of tibial torsion
- By overlapping the two components and using touch-fasteners, infinite positions of adjustments can be made to determine the amount of torque desired and the growth of the leg during correction



Size	Foot Length	Product No.		
		Left	Right	Pair
Upper Components				
X-Small	up to 3 ¹ / ₄ "	T3XSL	T3XSR	T3XSP
Small	up to 3 ³ / ₄ "	T3SML	T3SMR	T3SMP
Medium	up to 5 ¹ / ₂ "	T3MDL	T3MDR	T3MDP
Large	up to 6 ¹ / ₂ "	T3LGL	T3LGR	T3LGP
Lower Components				
X-Small	up to 3 ¹ / ₄ "	TEV 02-L	TEV 02-R	—
Small	up to 3 ³ / ₄ "	TEV 38-L	TEV 38-R	—
Small	up to 4 ¹ / ₄ "	TEV 915-L	TEV 915-R	—
Medium	up to 5"	CRB1624-L	CRB1624-R	—
Medium	up to 5 ¹ / ₂ "	CRB2536-L	CRB2536-R	—
Large	up to 6"	CRB3748-L	CRB3748-R	—
Large	up to 6 ¹ / ₂ "	CRB4960-L	CRB4960-R	—

Knit-Rite - KAFO Interface Socks

- Sold each

Description	Width/Length	White	Pink	Purple
Child Long	2 ¹ / ₂ " x 18"	1SP1AFCL	1S21AFCL	1S31AFCL

KAFO Interface Socks with X-Static - The Silver Fiber

- Sold each

Description	Width/Length	Navy	Gray	Black
Child Long	2 ¹ / ₂ " x 18"	1NX1AFCL	1SX1AFCL	1BX1AFCL



Pediatric
Knee Orthoses



AliMed - Abduction Wedge and Pillow

- Polyurethane foam abduction wedge or pillow with ultrasoft hook-and-loop straps
- Fire-resistant foam
- An anti-microbial abduction wedge is also available
- Dimensions: 17" x 12" x 7"
- 2 per case

Product No.

95-263

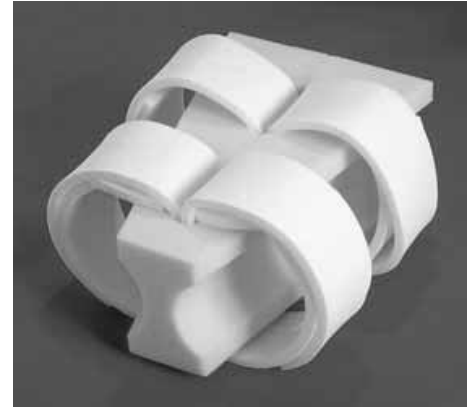

Allard USA - S.W.A.S.H.® Classic

- Engineered with a complex series of angles to maintain good hip alignment as the uprights follow the femurs' pathways of motion
- While standing or walking, SWASH provides just enough abduction to prevent scissoring and medial femoral rotation
- As the hips are flexed to assume the sitting position, it automatically further abducts the hips to create a tripod base for enhanced sitting stability and more upright posture
- Single strap fixed front closure to secure torso support
- 6 mm (size 1) and 7 mm (sizes 2-4) diameter uprights
- "Childproof" thigh cuff closure
- Available with 115° or 123° uprights
- Available in White plastic/Beige padding



Size	Pelvic	Product No.		
		Cuffs	115° Upright	123° Upright
Size 1	288000001	288030001	288010001	288020001
Size 1A	—	288030015	—	—
Size 2	288000002	288030002	288010002	288020002
Size 3	288000003	288030003	288010003	288020003
Size 4	288000004	288030004	288010004	288020004

S.W.A.S.H. Classic Sizing Chart						
Size	Circumference		Diameter	Overall Length	Uprights	
	Pelvic Section	Thigh Cuffs			Prox. Width	Distal Length
1	15 ³ / ₄ "-18 ¹ / ₄ "	8 ¹ / ₄ "-9 ³ / ₄ "	6"	12 ¹ / ₄ "	2 ¹ / ₂ "	7"
1A	15 ³ / ₄ "-18 ¹ / ₄ "	8 ¹ / ₄ "-9 ³ / ₄ "	7"	12 ¹ / ₄ "	3 ¹ / ₄ "	7"
2	18"-21 ³ / ₄ "	9 ³ / ₄ "-11 ¹ / ₂ "	7"	14 ³ / ₄ "	3 ¹ / ₄ "	8 ¹ / ₂ "
3	21 ¹ / ₄ "-24 ¹ / ₄ "	11 ¹ / ₂ "-13"	7"	17 ¹ / ₄ "	3 ¹ / ₄ "	11"
4	24 ¹ / ₂ "-28 ¹ / ₄ "	13"-15"	7"	19"	3 ¹ / ₄ "	12 ¹ / ₂ "

Pediatric
Hip Orthoses



S.W.A.S.H.® Low-Profile

- Anatomically shaped metal pelvic section rests over the pelvis and is secured in position by a small plastic reinforced abdominal pad
- Double strap front closure allows symmetrical application
- 8 mm diameter uprights in all sizes
- Interchangeable thigh cuff size
- Contoured posterior joints reduce interference with posterior walkers and other standing/walking/sitting aids
- Available with 115° or 123° uprights
- Available in Blue



Size	Pelvic	Cuffs	Product No.	
			115° Upright	123° Upright
Size 1	288350001	288420001	288400001	288410001
Size 2	288350002	288420002	288400002	288410002
Size 3	288350003	288420003	288400003	288410003
Size 4	288350004	288420004	288400004	288410004
Size 5	288350005	288420005	288400005	288410005
Size 6	288350006	288420006	288400006	288410006

S.W.A.S.H. Low-Profile II Sizing Chart						
Size	Circumference		Diameter	Overall Length	Uprights	
	Pelvic Section	Thigh Cuffs			Prox. Width	Distal Length
1	15 ³ / ₄ "-18 ¹ / ₄ "	8 ¹ / ₄ "-9 ³ / ₄ "	8"	12 ¹ / ₄ "	2 ¹ / ₂ "	7"
1A	15 ³ / ₄ "-18 ¹ / ₄ "	8 ¹ / ₄ "-9 ³ / ₄ "	8"	12 ¹ / ₄ "	3 ¹ / ₄ "	7"
2	18"-21 ³ / ₄ "	9 ³ / ₄ "-11 ¹ / ₂ "	8"	14 ³ / ₄ "	3 ¹ / ₄ "	8 ¹ / ₂ "
3	21 ¹ / ₄ "-24 ¹ / ₄ "	11 ¹ / ₂ "-13"	8"	17 ¹ / ₄ "	3 ¹ / ₄ "	11"
4	24 ¹ / ₂ "-28 ¹ / ₄ "	13"-15"	8"	19"	3 ¹ / ₄ "	12 ¹ / ₂ "
5	28"-32"	15"-17"	8"	21 ¹ / ₄ "	3 ¹ / ₂ "	14 ¹ / ₂ "
6	32 ¹ / ₂ "-35 ¹ / ₂ "	17 ¹ / ₄ "-19 ¹ / ₂ "	8"	23 ¹ / ₂ "	4"	16 ¹ / ₂ "



Becker Orthopedic - Maple Leaf Orthosis

- Designed for children between the ages of 4 and 15 with Cerebral Palsy
- The Maple Leaf Orthosis is intended to maintain the length of involved musculature and to control or prevent the recurrence of deformity after soft tissue release or other related hip surgeries
- Can be fitted as an immediate post-operative orthosis
- It can also be applied at the first cast change or any time during the rehabilitative phase
- Model 147 incorporates the 2041-C hip joint and can be utilized when incremental adjustment, positioning and control of hip motion through a desired range is required



Size	Pelvic Diameter	Pelvic Circum.	Thigh Circum.	Product No.
X-Small	6"-7 ¹ / ₂ "	15"-18 ¹ / ₂ "	5"-7"	147-XS
Small	7 ³ / ₄ "-9 ¹ / ₂ "	19"-23 ¹ / ₂ "	7"-10 ¹ / ₂ "	147-S
Medium	9 ³ / ₄ "-11 ¹ / ₂ "	23"-27 ¹ / ₂ "	10"-13 ¹ / ₂ "	147-M
Large	11 ³ / ₄ "-13 ¹ / ₂ "	27"-32"	11"-14 ¹ / ₂ "	147-L

Monodos Joint

- Designed for the management of dynamic contractures
- Allows free rotation in one direction, but blocks all rotation in the opposite direction until released
- A single joint may be used for the right or the left side, upper or lower extremity, and for flexion or extension contractures
- Has a variety of clinical applications including Cerebral Palsy, Stroke, Spinal cord injury, cost effective alternative to serial casting
- Sold individually



Product No. **1900-C**

D-Bar - Dobbs Clubfoot Bar

- Independent movement and greater mobility of the brace prevents kids from escaping and pulling out of booties
- Allows children to sleep with one leg straight and the other bent thus reducing stress on the knees
- Allows independent leg movement; Reduces friction on the heels
- Completely adjustable and grows with the patient



Size	Expands from	Product No.
Regular	9"-14"	DCBMD-REGULAR
Small	6"-9"	DCBMD-SMALL



DeRoyal - Concave Hip Abduction Pillow

- Breathable, high density foam construction
- Concave sides hold legs in secure position
- Long foam straps with hook closure for easy application and adjustment
- Available in compressed packaging for efficient storage

Size	A	B	C	D	Qty.	Product No.
Infant	4 ¹ / ₂ "	5"	2"	2"	10/case	M60-076-I
X-Small	9"	10"	3"	4"	5/case	M60-076-XS

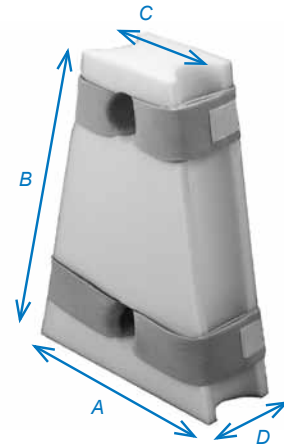

Fillauer - EZ Crawl with Bar

- Allows greater freedom of movement for crawling and other activities
- Quick detachment for diaper changes, donning and doffing
- Permits standing and full weight bearing
- Adjustable bar width to accommodate growth
- Lightweight and versatile design

Indications: Talipes Equinovarus (clubfoot)

Product No. **012400**



Night Splints

- Available with rivet-on plates or detachable clamps
- Include embossed protractor wrench
- Splints with rivet-on plates also include hex key
- Small plates fit up to shoe size 4; large plates fit above size 4¹/₂

Size	Detachable Clamps	Rivet-On Shoe Plate	
		Small	Large
4"	010017	012005	012229
5"	010025	012013	012237
6"	010033	012021	012245
7"	010041	012039	012252
8"	010058	012047	012260
9"	010066	012054	012278
10"	010074	012062	012286
12"	010082	012070	012294
14"	010090	012088	012302
16"	010108	012096	012310



Night Splints with Adjustable Bar

Description	Bar Length	Product No.
With Rivet-On Plates		
Small Plates	7"-11"	012195
Small Plates	9"-15"	012203
Large Plates	7"-11"	012196
Large Plates	9"-15"	012204
With Detachable Clamps		
Detachable Clamps	7"-11"	010215
Detachable Clamps	9"-15"	010223



Orthomerica - The Newport Jr Hip System

- The Newport Jr Hip with the new PJ—Virtual® Pediatric Joint enhances hip stability by supporting and positioning the hips in optimal alignment while allowing controlled range-of-motion
- Used post-operatively to maintain the corrected surgical position, or can be provided to maximize function during activities of daily living
- Alignment through the hip encourages appropriate acetabular and femoral modeling; reduces subluxation and dislocation
- Universal pelvic module; Bilateral thigh cuffs
- Anatomical design captures and stabilizes the pelvis

Size	Waist Circum.	Mid. Thigh Circum.	Troc. to Knee Center Length	Product No.
X-Small	17 ⁷ / ₈ "-19"	9 ⁷ / ₈ "-10 ⁷ / ₈ "	7 ¹ / ₄ "-8 ¹ / ₂ "	3919
Small	18 ³ / ₄ "-20 ¹ / ₄ "	10 ⁵ / ₈ "-12 ³ / ₁₆ "	8 ¹ / ₈ "-10 ¹ / ₈ "	3920
Medium	20"-22"	11 ³ / ₁₆ "-13 ³ / ₄ "	9 ¹ / ₂ "-11 ⁷ / ₈ "	3921
Large	21 ³ / ₄ "-23 ³ / ₄ "	12 ³ / ₄ "-15 ³ / ₁₆ "	11 ¹ / ₂ "-14"	3922
X-Large	23 ¹ / ₂ "-25 ¹ / ₂ "	14"-16 ⁷ / ₈ "	13 ⁷ / ₈ "-16 ³ / ₈ "	3923

Adjustable Abduction Bar				
Size	Fits Pelvic Sections	Adj. Range	Attached	Kit Only
Short	XS & SM	6.35"-9.85"	3950	3950.01
Long	MD, LG and XL	9.675"-17"	3951	3951.01

Pelvic and Thigh Components			
Size	Pelvic Assembly	Thigh Assembly	
		Left	Right
X-Small	3929	3939	3944
Small	3930	3940	3945
Medium	3931	3941	3946
Large	3932	3942	3947
X-Large	3933	3943	3948



Virtual® Pediatric Joint (PJ) (not pictured)

- The smallest and lightest hip joint available in the market
- Adjustable control of flexion, extension, abduction and adduction
- Curved proximal joint attachments provide clearance over the incision and trochanter

Size	Joint Distal Bar Size	Product No.
X-Small	Extra Short	4310
Small	Short	4311
Medium	Short	4311
Large	Long	4312
X-Large	Long	4312

Adjustable Hip Abduction Splint

- Lightweight pediatric orthosis offers advantage of abduction adjustment over the basic pediatric hip splint
- Sturdy polypropylene frame set in 90° hip flexion
- Abduction easily adjustable 40°-180° by stainless steel slotted screw assembly
- Easy application, removal facilitates diaper changes; closed cell foam does not retain moisture

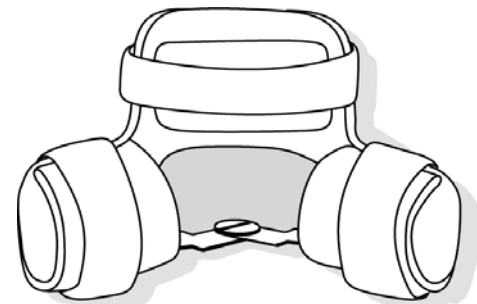

Adjustable

Standard Hip Abduction Splint

- Maintains concentric reduction of hips in patients with hip dysplasia
- Replaces spica casts and harnesses for certain developmental dysplasia patients
- One piece, non-adjustable polypropylene orthosis that holds infant in 90° hip flexion and 60° abduction
- Open design facilitates diaper changes
- Closed cell foam lining does not retain moisture

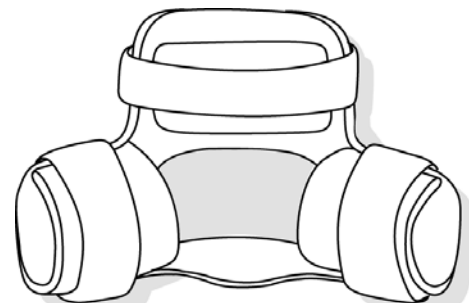

Standard

Size	Age	Weight	Product No.	
			Adjustable	Standard
X-Small	up to 3 months	6-12 lbs	3906	3899
Small	3-6 months	13-16 lbs	3907	3900
Medium	6-12 months	17-21 lbs	3908	3901
Large	1 year	22-30 lbs	3909	3902
X-Large	18 months	over 30 lbs	3910	3903

Pediatric
Hip Orthoses



RCAI - Pediatric Hip Stabilizer

- Provides abduction and rotation control for hip dislocations, replacements, revisions and fractures
- 15° hip abduction with adjustable flexion, extension motion control settings
- Adjusta-Belt back panel accommodates a wide range of sizes
- Bilateral or unilateral hip stabilization; Interchangeable left or right

Size	Hip Circum.	Product No.		
		Left	Right	Bilateral
Pediatric	16"-23"	66HS-P-L	66HS-P-R	66BHS-P
Small	24"-33"	66HS-S-L	66HS-S-R	66BHS-S



Pediatric Leg Brace (not pictured)

- Bilateral hinges provide increased flexion, extension knee control from 0° to 120°
- Lightweight, assures patient compliance
- Precision length adjustment hinge arm assures a personalized fit
- Cost effective alternative to casting for stable fractures

Size	Leg Length	Max. Circum of Thigh	Max. Circum of Calf	Product No.
Short	12"-14"	16"	14"	87PD-ULB-SX
Average	14"-16"	21"	15"	87PD-ULB-AV
Long	19"	22"	15"	87PD-ULB-LX

Hip Abduction Orthosis

- Provides stabilization for patients prone to chronic dislocation due to involved post-op hip revision
- Flexion/extension ROM control from 0° to 120° in 10° stop settings
- Abduction-adduction adjustments from 0° to 45° in 5° increments
- Vertical adjustability at hip or thigh
- Circumferential hip adjustment with padded pivotal back tilt

Size	Hip Circum.	Max. Thigh Circum.	Product No.		
			Left	Right	Bilateral
Toddler	16"-19"	11"	76HAO-T-L	76HAO-T-R	76BHAO-T
Child	19"-22"	14"	76HAO-C-L	76HAO-C-R	76BHAO-C
Youth	22"-25"	17"	76HAO-Y-L	76HAO-Y-R	76BHAO-Y



Pediatric
Hip Orthoses



Abduction Bar

- Provides adjustable abduction and adduction control for post surgical hip conditions or Legg Perthes disease
- Nylon ball-and-socket joints duplicate the anatomical motion of the hip during restricted ambulation
- Neoprene liner prevents the brace from migrating on the legs



Size	Mid-Thigh Circum.	Cuff Height	Product No.	
			Narrow Bar	Wide Bar
Pediatric	12"-18"	3 1/2"	26AB-P-N	26AB-P-W
Pediatric X-Narrow	8 1/2"-13"	3 1/2"	—	26AB-P-XN

Rhino POD, Inc. - Cruiser Hip Abduction Brace

- Polypropylene hip abduction brace for childer from infants up to 3 years of age with hip dysplasia
- Holds hips in the correct abduction position, but flexible enough to allow walking
- Can be used full time or for night wear only
- Commonly used as a follow-up to the "Kicker" Pavlik harness treatment as the child begins to walk



Size	Waist Circumference	Product No.
X-Small	14"-16"	ABD XS
Small	16"-18"	ABD S
Medium	18"-20"	ABD M
Large	20"-22"	ABD L
X-Large	22"-26"	ABD XL

Trulife - Model 129 Adjustable Hip Abduction Splint

- Designed to maintain abduction for treatment of hip dysplasia and dislocations in infants
- Adjustable abduction bar maintains precise degree of abduction and accommodates growth
- Lightweight with foam-padded edges for comfort
- Hook and pile closure on cuffs facilitates application and removal



Size	Distance Between Knees in Abducted Position	Waistband Adjustment	Thigh Cuff Adjustment	Product No.
X-Small	5"-6"	19"-20 3/4"	9"-12"	0012901
Small	7"-9"	19 1/2"-21"	10"-12"	0012902
Medium	10"-12"	19 1/2"-22 3/4"	11"-13"	0012903
Large	13"-15"	19 1/2"-24"	12"-13 1/4"	0012904

Pediatric
Hip Orthoses



Fast-Wrap Pavlik Harness

- Utilizes the principle of flexion with free abduction to achieve reduction of hip dysplasia and dislocation in infants
- Allows necessary joint movements
- Ideal alternative to hip casting, eliminating skin problems commonly associated with casting
- Fast-Wrap design features hook and pile closures for easy application, size adjustment, and removal
- Quick-release buckle provides secure, safe closure
- May be fitted under or over diaper

Size	Circumference	Product No.
X-Small	10"-14"	0011501
Small	13"-16"	0011502
Medium	16"-20"	0011503
Large	20"-24"	0011504



Non-Adjustable Hip Abduction Splint

- Non-Adjustable Hip Abduction Splint is a one piece plastic construction with simple hook and loop closures
- No adjustments-eliminates the chances of incorrect positioning
- 90° hip flexion, 60° abduction; polypropylene
- Easy to apply, one piece construction

Size	Waist	Age	Weight	Thigh	Product No.
X-Small	13"-17"	up to 3 mo.	6-12 lbs	10"	8101D
Small	14"-18"	3-6 mo.	13-16 lbs	11"	8102D
Medium	16"-20"	6-12 mo.	17-21 lbs	13"	8103D
Large	17"-21"	1 year	22-30 lbs	15"	8104D
X-Large	18"-22"	18 mo.	over 30 lbs	19"	8105D





Wheaton™ Brace Co. - Hip Abduction Orthosis

- Flexible one-piece molded LDPE construction molds to body and keeps hips flexed at 90°
- Touch closures allow for easy on and off
- Adjustable model can be set from 40°-80° abduction; non-adjustable model is fixed at 60° abduction
- Available in White

Size	Age	Weight	Product No.	
			Adjustable	Non-Adjustable
X-Small	up to 3 mo.	6-2 lbs	L1650-XS	L1660-XS
Small	4-6 mo.	13-16 lbs	L1650-S	L1660-S
Medium	7-12 mo.	17-21 lbs	L1650-M	L1660-M
Large	13-18 mo.	22-30 lbs	L1650-L	L1660-L
X-Large	19+ mo.	30+ lbs	L1650-XL	L1660-XL



Thumb Spicas/Supports					
North Coast Medical	Comfort Cool Thumb CMC Restriction Splint				
	<ul style="list-style-type: none"> • Wraparound supports are made of thin 1/16" perforated neoprene with a terry cloth liner • Reinforced stitching allows splint to be trimmed below the thumb MP joint • Contoured neoprene strap wraps around the thumb CMC joint and first metacarpal for direct CMC joint support 				
	Size	Circumference of the MP Joint	Product No.		
			Left	Right	
	Toddler	4 1/2"-5 1/2"	NC79546	NC79547	
	Youth	5 1/2"-6 1/2"	NC79548	NC79549	
RCAI	Universal Thumb/Wrist Thumb Support				 <p>Wrist</p>  <p>Thumb Wrist</p>
	<ul style="list-style-type: none"> • Gently places the thumb in a position of function and limits extreme motion of the joints of the thumb • A bendable metal stay limits radial and palmar abduction of the CMC joint and flexion/extension of the MCP joint • Breathable airprene material 				
	Size	Measure IP Crease to Wrist	Product No.		
			Thumb	Wrist Thumb	
	Youth	2 1/2"-3"	510-UTS-Y	520-UWTS-Y	

Cock-Up Splints						
DeRoyal	Leatherette Wrist and Wrist/Forearm Splint					
	<ul style="list-style-type: none"> • Durable leatherette material with foam tricot lining • Extra-wide loop lock strap at wrist for compression and support • Does not extend past the distal palmar crease, allowing full finger range-of-motion 					
	Size	11" Wrist/Forearm				
		Left	Right			
	Pediatric (6")	8824-06	8824-01			
ProCare (DJO)	Loop-Lock Cock-Up Splint					
	<ul style="list-style-type: none"> • Sturdy canvas construction with loop-lock closure • Splint allows full finger function above palmar crease 					
	Size	Wrist Circum.	Product No.			
			6" Left	6" Right	8" Left	
	X-Small/Ped.	up to 5 1/2"	79-87372	79-87362	79-87412	79-87402
	Small	5 1/2"-6 1/2"	79-87373	79-87363	79-87413	79-87403

Pediatric
Upper Extremity



Cock-Up Splints (continued)

Truform	2364 Canvas Cock-Up Wrist Splint					
	<ul style="list-style-type: none"> • Durable 7" long canvas glove, flannel lined for comfort • Soft elastic gusset • Self-adjusting dual cluster lacing with criss-cross hook-and-pile fastening tabs • Removable preshaped metal stay 					
		Width of Palm	White		Gray	
	Size		Left	Right	Left	Right
2X-Small	3 ¹ / ₂ "-4 ¹ / ₂ "	2364/L-XXS	2364/R-XXS	2364E/L-XXS	2364E/R-XXS	
X-Small	4 ¹ / ₂ "-5 ¹ / ₂ "	2364/L-XS	2364/R-XS	2364E/L-XS	2364E/R-XS	
Small	5 ¹ / ₂ "-6 ¹ / ₂ "	2364/L-S	2364/R-S	2364E/L-S	2364E/R-S	



LEEDer Group - 1-2-3 PRO-REST Hand Splint

- Flex-E-Core Neuro-Dynamic Therapy designed for mild to moderate contractures of wrist, hand and fingers
- REST is adjustable without heat or tools
- Includes extra cover and finger separators
- Sized by distance between wrist and elbow crease

Size	Width of MP Joint	Wrist to Fingertips	Wrist to Elbow Crease	Fleece		Velfoam	
				Left	Right	Left	Right
Pediatric	up to 2 ¹ / ₂ "	up to 6"	up to 6"	LRPL	LRPR	LRPLNF	LRPRNF
Small	2 ¹ / ₂ "-3"	6"-7"	6"-8"	LRSL	LRSR	LRSLNF	LRSRNF



Lenjoy - Comfyrene Separate Finger Hand Orthosis

- Includes removable finger separators
- Adjust individual fingers and thumb
- Low-profile straps adhere anywhere
- Available in Camouflage and Purple
- Wrist to top of middle finger: 4¹/₂"-6"

Indications: Dupuytren's; Swan neck; Boutonniere contractures; Sprains; Fractures



optional finger separator

Size	Product No.			
	Camouflage		Purple	
	Left	Right	Left	Right
Pediatric	HSF-101-CP-PL-C-L	HSF-101-CP-PL-C-R	HSF-101-CP-PL-P-L	HSF-101-CP-PL-P-R

Pediatric
Upper Extremity



Comfyrene Hand Thumb Orthosis

- Supports the hand, wrist, fingers and thumb without stretching the thenar eminence
- Comes with disposable liners

Indications: Adducted thumbs



Size	Wrist to Top of Middle Finger	Product No.	
		Light Blue	Dark Blue
Small	2 ¹ / ₂ "-3 ¹ / ₂ "	HT-101-CP-PS-LB	HT-101-CP-PS-DB
Medium	3"-4 ¹ / ₂ "	HT-101-CP-PM-LB	HT-101-CP-PM-DB
Large	4 ¹ / ₂ "-6"	HT-101-CP-PL-LB	HT-101-CP-PL-DB

Comfy Hand Wrist Finger Orthosis

- Gradual extension of non-fixed wrist, hand or finger flexion
- Easy adjustability at all joints allows them to be used for multiple indications to optimize functionality
- Wings are bent upwards to prevent ulnar/radial deviation
- Available in Navy Blue



**Shown with optional finger separator*

Size	Wrist to Top of Middle Finger	Product No.
Small	2 ¹ / ₂ "-3 ¹ / ₂ "	PH-101-S
Medium	3"-4 ¹ / ₂ "	PH-101-M
Large	4 ¹ / ₂ "-6"	PH-101-L
Accessories		
Cover for Comfy Hand		HC-1
Optional Finger Separator (replace ? with S, M, or L)		PFS1-?

Comfy Hand Thumb Orthosis

- Works the same as the Standard Comfy Hand Orthosis with extra tab for adducted thumb
- Splint is ambidextrous
- Optional removable finger separator (FS-1)
- Available in Navy Blue



Size	Wrist to Top of Middle Finger	Product No.
Small	2 ¹ / ₂ "-3 ¹ / ₂ "	PHT-101-S
Medium	3"-4 ¹ / ₂ "	PHT-101-M
Large	4 ¹ / ₂ "-6"	PHT-101-L

Pediatric
Upper Extremity



Comfy Opposition Thumb Hand Orthosis

- Adjustable “C” bar support to hold the thumb in opposition
- Provides gradual extension of the wrist, hand, finger and thumb
- Comes with patented Comfy frame and absorbent terry cloth cover
- Available in Navy Blue



Size	Wrist to Top of Middle Finger	Product No.	
		Left	Right
Small	2 ¹ / ₂ "-3 ¹ / ₂ "	POPH-101-S-LT	POPH-101-S-RT
Medium	3"-4 ¹ / ₂ "	POPH-101-M-LT	POPH-101-M-RT
Large	4 ¹ / ₂ "-6"	POPH-101-L-LT	POPH-101-L-RT

Spring Loaded Goniometer Hand “Set ROM with Extension”

- Dynamic hand orthosis that gives a gentle push to extension of the wrist or can be set in a fixed static position
- Ability to set the range of flexion and extension desired at the wrist joint by setting patented Goniometer dial
- Re-adjustable custom fit of wrist, MP, PIP & DIP joints
- Goniometer dial and metal are protected with padded soft cover



Size	Wrist Measurement	Length	Product No.
Small	2 ¹ / ₂ "-3 ¹ / ₂ "	7"	PSGH-101-S
Medium	3"-4 ¹ / ₂ "	8"	PSGH-101-M
Large	4 ¹ / ₂ "-6"	9 ¹ / ₂ "	PSGH-101-L

Comfy Goniometer Elbow “Set ROM”

- Treats non-fixed contractures of the elbow
- Works in the same way as serial casting, allowing progressive extension by gradually adjusting and re-adjusting in 10° increments
- Allen wrench conveniently stored under the cover in the frame of the orthotic
- Available in Navy Blue



Size	Elbow Crease to Wrist	Elbow Crease to Shoulder	Total Length	Product No.
Small	3 ¹ / ₄ "	3 ¹ / ₄ "	6 ¹ / ₂ "	PGE-101-S
Medium	3 ³ / ₄ "	3 ³ / ₄ "	7 ¹ / ₂ "	PGE-101-M
Large	4 ¹ / ₂ "	4 ¹ / ₂ "	9"	PGE-101-L

Pediatric
Upper Extremity



Comfy Spring Loaded Goniometer Elbow “Set ROM with Extension”

- Dynamic splint works like the Goniometer elbow with added feature of having a spring that gently pushes
- Spring strength is fixed
- Allen wrench conveniently stored in frame under the cover
- Available in Navy blue

Size	Elbow Crease to Wrist	Elbow Crease to Shoulder	Total Length	Product No.
Small	3 ¹ / ₄ ”	3 ¹ / ₄ ”	6 ¹ / ₂ ”	PSGE-101-S
Medium	3 ³ / ₄ ”	3 ³ / ₄ ”	7 ¹ / ₂ ”	PSGE-101-M
Large	4 ¹ / ₂ ”	4 ¹ / ₂ ”	9”	PSGE-101-L



Comfy Combination Elbow Hand Orthosis

- Extends the elbow and hand simultaneously
- Includes hand roll attachment or full hand attachment, which can be rotated to accommodate pronation and supination
- Comes with one cover
- Available in Navy Blue

Indications: Spastic hand and elbow taking into account the flexion synergy of the upper extremity

Size	Elbow Crease		Product No.	
	to Wrist	to Forearm/ Shoulder	Hand Roll	Full Hand
Small	5”-7”	3 ¹ / ₄ ”	EH-101-HR-PS	EH-101-FH-PS
Medium	7”-9”	3 ³ / ₄ ”	EH-101-HR-PM	EH-101-FH-PM
Large	9”-11”	4 ¹ / ₂ ”	EH-101-HR-PL	EH-101-FH-PL



Comfy Elbow “Bend to Fit”

- Cuffs are bendable to allow for optimal fit
- Use as a resting splint or for the gradual extension of non-fixed elbow contractures
- One size fits most adults
- Available in Navy Blue

Size	Elbow Crease		Total Length	Circum. of Biceps	Product No.
	to wrist	to Shoulder			
Small	3 ¹ / ₄ ”	3 ¹ / ₄ ”	6 ¹ / ₂ ”	4”-6”	PE-101-S
Medium	3 ³ / ₄ ”	3 ³ / ₄ ”	6 ¹ / ₂ ”	6”-8”	PE-101-M
Large	4 ¹ / ₂ ”	4 ¹ / ₂ ”	9”	8”-10”	PE-101-L



Pediatric
Upper Extremity



OCSI/Neuroflex - Softpro™ Functional Resting Hand

- Treats moderate contractures of the wrist/hand/fingers
- Bend-to-fit; Easily molds without tools yet sturdy enough to maintain shape during wear
- Extra long wrist strap holds the wrist in the proper position and applies a gentle stretch
- Width is measurement of MP Joints; Length is measurement of wrist to fingertip

Size	Width of MP Joints	Length Wrist to Finger Tip	Product No.	
			Left	Right
Child	1 ³ / ₄ "- 2"	Length of Splint: 8"	SP31FFR-SL	SP31FFR-SR
Youth	1 ³ / ₄ "- 2 ¹ / ₂ "	Length of Splint: 9"	SP31FFR-ML	SP31FFR-MR



ProCare (DJO) - Universal Pediatric Wrist Splint (not pictured)

- Breathable foam laminate construction
- Stockinette added at the strap area for additional patient comfort
- Latex-free

Indications: Sprains, strains, Carpal Tunnel Syndrome and post-operative rehabilitation of the wrist

Size	Length	Product No.	
		Left	Right
Pediatric	4 ¹ / ₂ "	79-87430	79-87420
Child	6"	79-87450	79-87440

RCAI - Resting Hand Orthosis

- Can be heat molded at low temperature
- Liner eliminates potential pressure points, while moisture is "wicked" away keeping the skin dry and comfortable
- Raised lateral palmar ridges of the orthosis discourage radial or ulnar deviation, and reinforce the orthosis to accommodate muscle tone and spasticity

Indications: Stroke; Trauma; Injury; Rheumatoid arthritis, Arthroplasties; Burns and early wrist and finger contractures

Size	Palm Width	Length	Product No.	
			Left	Right
Infant	3/4"-1 ¹ / ₂ "	5"	29RHO-I-L	29RHO-I-R
Toddler	1 ¹ / ₄ "-1 ³ / ₄ "	7"	29RHO-T-L	29RHO-T-R
Child	1 ¹ / ₂ "-2"	8"	29RHO-C-L	29RHO-C-R
Youth	1 ³ / ₄ "-2 ¹ / ₄ "	9"	29RHO-Y-L	29RHO-Y-R
X-Small	2"-2 ¹ / ₂ "	10"	29RHO-ES-L	29RHO-ES-R



Pediatric
Upper Extremity



Dorsal Wrist Splint

- Limits wrist flexion and extension
- Made of lightweight, durable Kydex plastic
- Can be heat molded for customization and positioning
- Ortho-Wick Liner

Size	Width of Palm	Product Length	Product No.	
			Left	Right
X-Small	2"-2 1/2"	5 1/2"	44DCT-ES-L	44DCT-ES-R
Small	2 1/2"-3"	6 1/2"	44DCT-S-L	44DCT-S-R



44DC

The Universal Arm Brace

- Bilateral hinges provide increased flexion and extension elbow control 0°-120°
- Precision length adjustment hinge arm assures a personalized fit
- Forearm design provides protection of the olecranon process
- Humeral circumference: 9"-11"; Product length: 10"

Indications: Elbow surgery; Tendon or muscle repair; Strains; Sprains; Stable humeral or forearm fractures

Product No. **88UAB-P**



88UAB-Sx

DeRoyal - Specialty Arm Sling

- Durable navy canvas construction with deep pocket design
- Thumb loop helps prevent wrist drop
- Adjustable slide buckle on strap for best fit
- Hook and loop closure with O-rings

Indications: Cast support; Injuries to the arm, wrist or hand; Acromioclavicular sprains; Anterior glenohumeral dislocations

Size	Pouch Strap	Strap Length	Product No.	
			Foam Pad	Vinyl Pad
Infant	5" x 9"	1" x 21"	8004-01	8004-11
Child	6" x 11"	1" x 27"	8004-02	8004-12



Pediatric
Upper Extremity



ProCare (DJO) - Deluxe Arm Sling with Pad

- Generous size envelope to support the arm
- Cotton/poly with fully padded web strap and contact closure
- Thumb loop helps prevent sling from migrating

Indications: Cast support; Injuries to the arm, wrist or hand

Size	Depth x Length	Product No.
Pediatric/2X-Small	6 ¹ / ₂ " x 9"	79-84001
Child/X-Small	7" x 11 ¹ / ₄ "	79-84002



Healthcare Bear Arm Sling

- Cotton/poly envelope with Healthcare Bear design
- Cotton web strap with quick-release buckle for easy application

Indications: Cast support; injuries to the arm, waist or hand

Size	Depth x Length	Product No.
Pediatric	4 ³ / ₄ " x 11 ¹ / ₂ "	79-99132
Child	6 ³ / ₄ " x 13 ¹ / ₂ "	79-99133



Deluxe Shoulder Immobilizer

- Adjustable wrist cuff and shoulder strap may be positioned as needed for proper control and custom fit
- Fits right or left and may be worn without shoulder strap

Indications: Treatment of traumatic or post-surgical immobilization

Size	Waist Measurement	Product No.
Child	up to 38 ¹ / ₂ "	79-84101



Pediatric
Upper Extremity



**Professional Products - Tapered Arm Sling/
Shoulder Immobilizer**

- Tapered arm sling for use with a cast
- Durable blue twill pocket has 2" comfort foam shoulder strap for maximum comfort
- Thumb loop maintains hand in neutral position and prevents sling from migrating
- Hook and loop closure



Size	Forearm Measurement	Product No.
Pediatric	6"-8"	02351
*Must specify size at time of order		

**Becker Orthopedic - Shoulder Abduction
Rotation Orthosis**

- The low-profile SARO is easily adjustable, lightweight, and can be used for pre and post-operative management of the pediatric shoulder joint
- The adjustments at the shoulder joint allow the clinician to precisely align the child's joint and upper extremity

Indications: Paralysis or damage to the brachial plexus (Erb palsy); Prevention of upper extremity joint contractures; Brachial plexus exploration and nerve repair; Soft tissue surgery, including tendon transfers



Size	Age	Design	Product No.
Small	Under 4 years	Tornado	190-S-T
Small	Under 4 years	Sky	190-S-S
Medium	4-8 years	Tornado	190-M-T
Medium	4-8 years	Sky	190-M-S

RCAI - Over the Shoulder Humeral Fracture Brace

- A universal design for humeral diaphyseal fractures and deep humeral bone bruises
- Allows range-of-motion at shoulder and elbow
- Trimmable polyethylene and lined with closed-cell foam
- Lightweight, durable, and cannot absorb moisture



Size	Mid-Humeral Circumference	Product No.
Toddler	3 1/2"-6 1/2"	54HFB-OS-T
Child	4"-6 1/2"	54HFB-OS-C
Youth	5"-8"	54HFB-OS-Y
X-Small	5"-7 1/2"	54HFB-OS-ES

Pediatric
Upper Extremity



Clavicle Straps

- Indications: Clavicular fractures; Posture correction; Acromioclavicular separations

DeRoyal

Premium Clavicle Strap

- Synthetic stockinette over foam padding does not absorb water and can be worn while bathing
- Serpentine stitch design to prevent migration
- Measurement taken at widest part of chest for men and below the bustline for women

Size	Chest Circumference	Product No.	
		Buckle	Hook-and-Loop
Infant	18"-20"	3001-01	3002-01
Child	20"-24"	3001-02	3002-02



Heavy-Duty Clavicle Strap

- Foam padding with stockinette covering
- Extra long straps for easy adjustment
- Measurement taken at widest part of chest for men and below the bustline for women

Size	Chest Circumference	Product No.	
		Buckle	Hook-and-Loop
Infant	18"-20"	3004-01	3004-11
Child	20"-24"	3004-02	3004-12



Knit-Rite - Cast-Rite Fracture Interfaces

Child Size Arm Sleeves

- Stretches and conforms to arm
- Machine wash and dry
- 1 ply; 97% acrylic, 3% Lycra spandex
- 2" flat width

Description	Product No
10" Thumbhole	1AL1A0CH
12" Wrist to Shoulder	1AL1WSCH

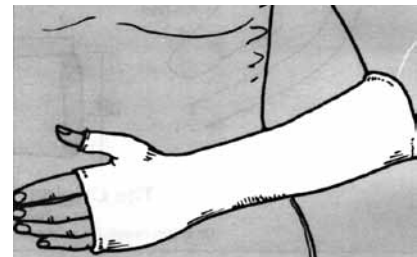
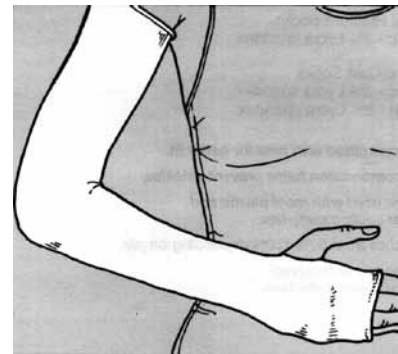

Pediatric
Upper Extremity



Torso Interface®

- Improved skin protection and patient comfort
- CoolMax®/Lycra® is a moisture wicking fiber
- X-STATIC/Lycra® and CoolMax®/Lycra® are antimicrobial to help eliminate odor in the garment
- Crew neck and V-neck styles are designed with ribbed edgings at neck, arm holes and waist band
- Torso-Interface provides more cushioning, moisture-wicking properties to keep skin dry, protected, and comfortable

Width X Length	Fits Circum.	Product No.
Crewneck - 1-Ply - Polyester/X-STATIC/Lycra		
6" x 14"	14"-18"	1BX1BSSM
8" x 16"	18"-24"	1BX1BSMD
Crew Neck - Cotton/Lycra		
4" x 12"	10"-12"	1BC1BSXS
6" x 14"	14"-18"	1BC1BSSM
8" x 16"	18"-24"	1BC1BSMD
Crew-Neck - Axilla Flaps - CoolMax/Lycra		
6" x 14"	14"-18"	1BP1DDSM
8" x 16"	18"-24"	1BP1DDMD

Size	Crew Neck	Strapless	Crew Neck with Sleeves	V-Neck with Axilla Flaps
X-Small	1BP1BSXS	1BP1B614	—	—
Small	1BP1BSSM	1BP1B816	1BP1SSSM	1BP1BDSM
Medium	1BP1BSMD	1BP1B820	1BP1SSMD	1BP1BDMD

<u>Left Flap</u>	<u>Double Flap</u>			
Width x Length	Width x Length	Fits Circum.	Left Flap	Double Axilla Flaps
V-Neck with X-STATIC - The Silver Fiber - 1-Ply - Polyester/X-STATIC/Lycra				
6" x 14"	6" x 16"	14"-18"	1BX1BLSM	1BX1BDSM
8" x 16"	8" x 18"	18"-24"	1BX1BLMD	1BX1BDMD

Width x Length	Fits Circum.	Product No.
Turtleneck with Sleeves - X-STATIC		
4" x 12"	10"-12"	1BX1BTXS
6" x 14"	14"-18"	1BX1BTSM
8" x 16"	18"-24"	1BX1BTMD
Without Straps or Caps - 1-Ply CoolMax/Lycra		
6" x 14"	14"-18"	1BP1B614
8" x 16"	18"-24"	1BP1B816



Crew Neck



Crew Neck with Sleeves



Pictured with Axilla Flaps



without straps or caps

Pediatric
Upper Extremity



Aspen Medical - Cervical Collar

- Two piece collar with breathable replacement pads
- Available in three child sizes, including the "Tot" collar designed for the 1-4 year age range
- Specifically designed to properly fit children; they are not simply downsized adult collars
- Wider chin pieces to accommodate children's chubby cheeks and are designed to stand away from the throat

Size	Age	Collar Only	Collar w/Extra Pads
PD1 Infant Short (3/4")	3-18 mo.	983190	983192
PD2 Infant Regular (1 1/4")	9-24 mo.	983195	983197
PD3 Child Tot (2")	1-4 years	983106	983126
PD4 Child Short (2")	2-5 years	983102	983122
PD5 Child Regular (2 1/2")	3-6 years	983104	983124
Replacement Pads Available			
Size	Product No.		
PD2 Infant Regular	983199		
PD3 Child Tot	983156		
PD5 Child Regular	983155		



CTO Cervical Thoracic Orthosis

- Spinal orthosis used to stabilize the upper thoracic and cervical spine in the case of injury, degenerative spinal conditions, deformities, or corrective surgical procedures
- Provides anterior-posterior (sagittal plane), medial-lateral (coronal plane), and rotational (transverse plane) control of the upper spine
- Indications for use include stable cervical fractures or dislocations, cervical strains or sprains, post operative stabilization of the upper spine, rheumatoid arthritis, and spondylosis or other spine deformities

Description	Product No.
CTO Complete with collar	983301
Replacement pads	983302



Becker Orthopedic - Lerman Noninvasive Pediatric Halo

- Can be used in the management of a variety of pediatric cervical spine disorders
- The noninvasive halo successfully controls rotation and lateral bending of the cervical spine and can be successful in positioning the head and neck of children with congenital muscular torticollis
- Both sizes come complete with a semi-rigid and rigid back post

Indications: Positioning of structurally stable spine; Following complications of standard halo immobilization; Postoperative positioning following sternocleidomastoid release for congenital muscular torticollis; Reduction of C1-C2 rotary instability



Size	Head Circum. at Equator	Chest Circum. at Xyphoid	Product No.
Small	15"-22"	18"-22"	C-24-S
Medium	15"-22"	22"-28"	C-24-M

Knit-Rite - Infant Cranial Protection

- Designed for children wearing an orthosis to treat positional plagiocephaly and other head shape deformities
- Protects the skin, wicks moisture, controls rashes, and guards against dermatitis
- Stretch allows one size to fit heads of 3- to 18-month-old infants
- Available in two styles - Mullet and Balaclava

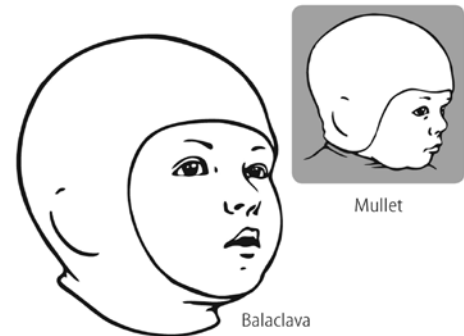

Description	Material	Product No.
Mullet Style	CoolMax/Lycra	1SP1MULL
Balaclava Style	CoolMax/Lycra	1SP1BACL
Mullet Style	Polyester/X-STATIC/Lycra	1XP1MULL
Balaclava Style	Polyester/X-STATIC/Lycra	1XP1BACL



Ossur Americas - Miami Jr.®

- Collars designed to meet the specific anatomical needs of children at each stage of their development up to 12 years

Size	Collar		Replacement Pads Only
	Extra Pad	with Pad	
P0 (0-6 months)	MJR-P0	MJ-P0	MJP-P0
P1 (6 months-2 years)	MJR-P1	MJ-P1	MJP-P1
P2 (2-6 years)	MJR-P2	MJ-P2	MJP-P2
P3 (6-12 years)	MJR-P3	MJ-P3	MJP-P3



NecLoc Kids®

- Designed to properly fit a child's anatomy while immobilizing the cervical spine and maintaining an open airway
- Each size is individually engineered for the specific age and stage of the child's growth to maintain optimal airway and c-spine alignment
- Unsurpassed NecLoc® immobilization
- X-ray, MR & CT transparent

Size	Product No.
P1 (0-2 years)	NL-P1
P2 (2-6 years)	NL-P2
P3 (6-12 years)	NL-P3



Philadelphia® Tracheotomy Collar

- Anterior and posterior rigid plastic reinforcement supports limited movement
- Total cervical arch support maintains neutral alignment of the cervical spine
- Latex-free, non-toxic and hypoallergenic Plastazote® foam reduces skin irritation; Water resistant

Indications: Degenerative disorders; Immobilization after trauma/surgery; Spinal Stenosis; Spondylolisthesis

Size	Height	Neck Circum.	Product No.	CoolMax Liners
Infant	1 ¹ / ₄ "	6"-8"	PHP-TI	PHP-LCI
Pediatric	1 ³ / ₄ "	8"-11"	PHP-TP	PHP-LCP



Atlas™ Collar

- Large trachea opening enables quick access for carotid pulse monitoring and emergency tracheotomies
- Easy to customize 2-piece design with shoulder and mandible contours to increase stability and comfort
- Rear panel increases ventilation to reduce heat and moisture while allowing cervical spine palpitation
- Latex-free, non-toxic and hypoallergenic, X-ray, CT and MRI lucent
- Pediatric Circumference: 8"-11"; Infant Circumference: 6"-8"

Indications: Degenerative disorders; Immobilization after trauma/surgery; Spinal Stenosis; Spondylolisthesis



Description	Collar Only	Collar with Extra Pad Set
Infant Short White (up to 1 yr)	PHP-A110	PHP-A111
Infant Regular Black (up to 1 yr)	PHP-A120	PHP-A121
Child Tot Gray (1-3 yr)	PHP-A210	PHP-A211
Child Short Pink (3-5 yrs)	PHP-A220	PHP-A221
Child Regular Aqua (5+ yrs)	PHP-A230	PHP-A231

Symmetric Designs - Headmaster Collar™

- Provides all around support
- Easily formed by hand
- Low profile, light and airy, low heat retention
- Available in Gray

Size	Measurement (a)	Product No.
Infant	2 1/2"	HMC06-G
Child	3"	HMC05-G
Junior	3 1/2"	HMC04-G

(a) is the shortest distance under the jaw from the center of the chin to the angle of the mandible



Pediatric
Cervical



Trulife - Johnson CTO

- Stabilizes cervical and upper thoracic spine with added occipital support
- Encapsulated occipital region for maximum support
- Molded, polyethylene anterior and posterior shells
- Contoured forehead strap; MRI safe

Indications: C4/5-T3/4 stable fractures; Post operative stabilization; Ankylosing spondylitis

Size	Height*	Neck Circumference	Product No.
Infant	6"-8"	8 ¹ / ₂ "-10"	JS-361-I
Pediatric	9"-11 ³ / ₄ "	9"-14 ¹ / ₂ "	JS-361
Replacement Pad Sets			
Infant			JS-361-I-PAD
Pediatric			JS-361-PAD

*Chin to distal edge of extension



Lerman MINERVA™

- Stabilizes cervical and upper thoracic spine
- Solid, injection molded anterior and posterior shells
- Height adjustable occipital shell and chin support
- Oval trachea opening

Indications: C3-T2 stable fractures; Ligament/muscular injuries; Degenerative joint disease; Cervical pain/nerve impingement

Size	Height	Product No.
Pediatric	9"-11"	A19303
Replacement Pad Set		O11394

