

Ankle Joints & Stirrups

- Becker Orthopedic 78-96
 - Double Action 78-85
 - Standard Action 86-90
 - Dorsiflexion Assist 90-94
 - Caliper Systems 95-96
- Fillauer 96-100
- Laurence Manufacturing 100
- OTS, Inc. 101-102
- Trulife 102-107

Knee Joints

- Becker Orthopedic 108-119
- Fillauer 119-122
- OTS, Inc. 122-124
- Trulife 124-126

Hip Joints

- Becker Orthopedic 127-129

Torsion Splints

- Becker Orthopedic 130-132

Leather Parts

- Becker Orthopedic 133-134
- Trulife 134-135

Double Action

Becker Orthopedic

2800 Series – Wide Flange Stirrup Only

- Wide flange stirrups were introduced to stabilize the forces on the foot and ankle
- Three configurations available; each is made from $\frac{1}{8}$ " stainless steel with two $\frac{3}{8}$ " bushing holes
- 2800-A standard wide flange stirrup has a $4\frac{1}{2}$ " tongue
- 2800-X is the same as 2800-A, with a 6" tongue for increased stability
- 2800-SX has a unique "web" configuration, making it the strongest Becker stirrup, and has an extended 7" tongue

Length	Product No.		
	2800-A	2800-X	2800-SX
8"	2800-A8	2800-X8	2800-SX8
$8\frac{1}{2}$ "	2800-A8.5	2800-X8.5	2800-SX8.5
9"	2800-A9	2800-X9	2800-SX9
$9\frac{1}{2}$ "	2800-A9.5	2800-X9.5	2800-SX9.5
10"	2800-A10	2800-X10	2800-SX10
$10\frac{1}{2}$ "	2800-A10.5	2800-X10.5	2800-SX10.5
11"	2800-A11	2800-X11	2800-SX11



Model 2700 – Standard Flange with 2800 Head

- Standard flange stirrup with a 2800 series head configuration
- Available in adult and youth sizes
- "Adult" size stirrup tongues measure $3\frac{1}{2}$ "; "Youth" size stirrup tongues measure $2\frac{4}{5}$ "

Size	Length	Product No.
Youth	$6\frac{3}{4}$ "	2700-B6.75
Youth	$7\frac{1}{2}$ "	2700-B7.5
Youth	$8\frac{1}{4}$ "	2700-B8.25
Youth	9"	2700-B9
Adult	$7\frac{1}{2}$ "	2700-A7.5
Adult	8"	2700-A8
Adult	$8\frac{1}{2}$ "	2700-A8.5
Adult	9"	2700-A9
Adult	$9\frac{1}{2}$ "	2700-A9.5
Adult	10"	2700-A10
Adult	$10\frac{1}{2}$ "	2700-A10.5
Adult	11"	2700-A11



2900 Series – Standard Flange Stirrup Only

- Recommended where a lightweight double action stirrup is required
- Adult and Youth: 1/8" stainless steel; two 3/8" bushing holes
- Child: 3/32" stainless steel; two 5/16" bushing holes
- "Adult" has 3 1/2" tongue; "Youth" has 2 4/5" tongue; "Child" has 2 1/10" tongue

Size	Length	Product No.
Model 2900-B Child Stirrup Only		
Child	4 1/2"	2900-C4.5
Child	5 1/4"	2900-C5.25
Child	6"	2900-C6
Child	6 3/4"	2900-C6.75
Model 2900-B Youth Stirrup Only		
Youth	6 3/4"	2900-B6.75
Youth	7 1/2"	2900-B7.5
Youth	8 1/4"	2900-B8.25
Youth	9"	2900-B9
Model 2900-A Adult Stirrup Only		
Adult	8"	2900-A8
Adult	8 1/2"	2900-A8.5
Adult	9"	2900-A9
Adult	9 1/2"	2900-A9.5
Adult	10"	2900-A10
Adult	10 1/2"	2900-A10.5
Adult	11"	2900-A11



2900-A

Ankle Joints
and Stirrups

Model 2810 – Stirrup Insert

- Stamped one-piece design (no welds) with a generous radius at the attachment portion and upright extension interface

Size	X	Y	Thickness	Product No.
Child	2 9/25"	1 4/5"	3/32"	2810-C1.8
Child	2 9/25"	2"	3/32"	2810-C2.0
Child	2 9/25"	2 3/10"	3/32"	2810-C2.3
Adult	3"	2 1/4"	1/8"	2810-A2.25
Adult	3"	2 1/2"	1/8"	2810-A2.5
Adult	3"	2 3/4"	1/8"	2810-A2.75
Adult	3"	3"	1/8"	2810-A3

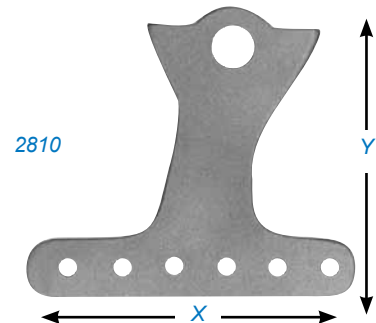

2810

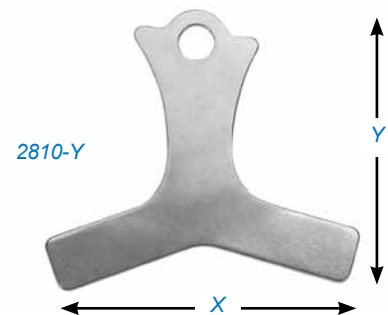

2810-Y

Double Action Y Stirrup Insert

- The "Y" shaped flanges are preferred by many orthotists

Size	X	Y	Thickness	Product No.
Child	3.36"	2.30"	3/32"	2810-C-Y
Adult	3.31"	2.61"	1/8"	2810-A-Y

2825 Series – Original Double Action Ankle Joints

- Joints are shipped complete with bushing, screw, ball bearings, springs, and hex set screws
- All "A" joints have $\frac{3}{8}$ " bushing hole
- All "C" joints have $\frac{5}{16}$ " bushing hole
- "A" size joints are used with both "A" and "B" size stirrups
- Sold individually

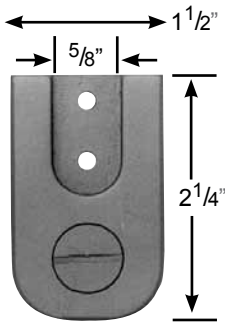

2825-A
Adult size
304 stainless steel
Slot Depth: $\frac{1}{8}$ "

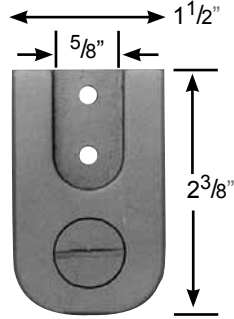

A2825-A
Adult Size
7075-T6 aluminum to
reduce weight
Slot Depth: $\frac{1}{8}$ "

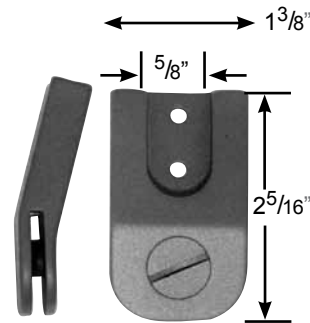

C2825-A
Adult Size
Contoured joint for better
cosmesis; 304 stainless steel
Slot Depth: $\frac{1}{8}$ "

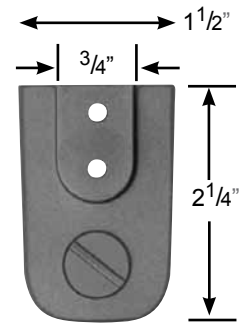

W2825-A
Adult Size
Accepts $\frac{3}{4}$ " wide
uprights; 304 stainless steel
Slot Depth: $\frac{1}{8}$ "

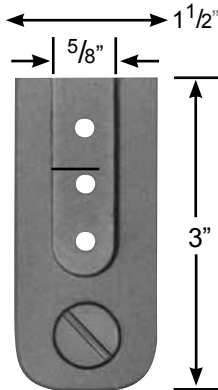

L2825-A
Adult size
Provides smoother
spring action
7075-T6 aluminum
Slot Depth: $\frac{1}{8}$ "

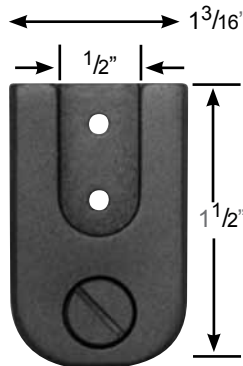

2825-C
Child size
304 stainless steel
Slot Depth: $\frac{3}{32}$ "

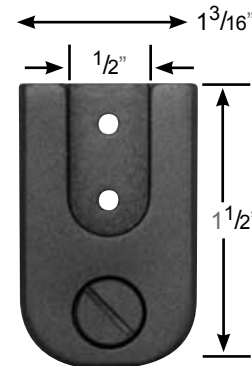

2825-C8
Child size
304 stainless steel
Compatible with "A" and "B"
size stirrups
Slot Depth: $\frac{1}{8}$ "

Includes
3870 Ring
(Bushing Adapter Ring)

Model 2845 – One-Piece Aluminum Double Action Ankle Joint and Upright

- Offers lighter weight and improved strength
- Sold individually
- "Adult" size uprights are pre-contoured for improved cosmesis

Size	Upright Dimensions	Product No.
Adult and Youth	$\frac{3}{16}$ " x $\frac{5}{8}$ " x $15\frac{1}{2}$ "	2845-A
Adult and Youth (w/pin)	$\frac{3}{16}$ " x $\frac{5}{8}$ " x $15\frac{1}{2}$ "	2845-AW/PIN
Child	$\frac{3}{16}$ " x $1\frac{1}{2}$ " x 8"	SC-2845-C

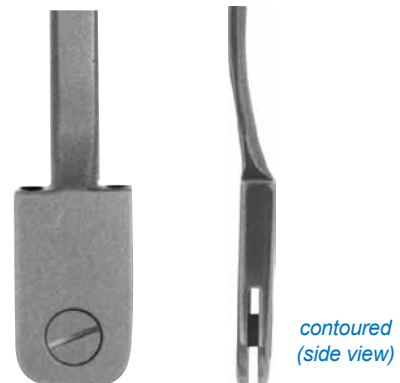

Model 2835 – Double Action Ankle Joint with Attached Upright

- Round edge aluminum (square edge aluminum uprights available upon request)
- Sold individually

To Fit Size	Upright Material	Upright Dimension	Product No.
Child	Aluminum	3/16" x 1/2" x 11"	2835-C6
Child	Aluminum	1/8" x 1/2" x 11"	2835-C8
Child	Stainless Steel	3/16" x 1/2" x 11"	2835-C6S
Child	Stainless Steel	1/8" x 1/2" x 11"	2835-C8S
Adult or Youth	Aluminum	1/4" x 3/4" x 15 ³ / ₁₆ "	W2835-A4
Adult or Youth	Aluminum	3/16" x 3/4" x 15 ³ / ₁₆ "	W2835-A6
Adult or Youth	Stainless Steel	3/16" x 3/4" x 15 ³ / ₁₆ "	W2835-A6S
Adult or Youth	Aluminum	1/4" x 5/8" x 15 ³ / ₁₆ "	2835-A4
Adult or Youth	Aluminum	3/16" x 5/8" x 15 ³ / ₁₆ "	2835-A6
Adult or Youth	Aluminum	1/8" x 5/8" x 15 ³ / ₁₆ "	2835-A8
Adult or Youth	Stainless Steel	3/16" x 5/8" x 15 ³ / ₁₆ "	2835-A6S
Adult or Youth	Stainless Steel	5/32" x 5/8" x 15 ³ / ₁₆ "	2835-A2S



2835

Ankle Joints
and Stirrups

SL2800 Series – Slim Line Wide Flange Stirrup

- Utilized with any Slim Line ankle joint to stabilize the forces on the foot and ankle
- Three configurations; each made from 1/8" stainless steel with two 3/8" bushing holes
- SL2800-A is a standard wide flange stirrup with 4 1/2" tongue
- SL2800-X is the same as Model SL2800-A, with 6" tongue for increased stability
- SL2800-SX has a unique "web" configuration and extended tongue (7")

Length	Series Product No.		
	SL2800-A	SL2800-X	SL2800-SX
8"	SL2800-A8	SL2800-X8	SL2800-SX8
8 1/2"	SL2800-A8.5	SL2800-X8.5	SL2800-SX8.5
9"	SL2800-A9	SL2800-X9	SL2800-SX9
9 1/2"	SL2800-A9.5	SL2800-X9.5	SL2800-SX9.5
10"	SL2800-A10	SL2800-X10	SL2800-SX10
10 1/2"	SL2800-A10.5	SL2800-X10.5	SL2800-SX10.5
11"	SL2800-A11	SL2800-X11	SL2800-SX11



SL2800-A



SL2800-X



SL2800-SX

Model SLI/SLO-2835 – Slim Line Double Action Ankle Joint with Attached Upright

- Modular ankle joint with upright attached
- Sold individually

<u>Product No.</u>	<u>Product No.</u>
Inside Recess	Outside Recess
Stainless Steel Joints with Aluminum Uprights	
SLI-2835-A4	SLO-2835-A4
SLI-2835-A6	SLO-2835-A6
SLI-2835-C6	SLO-2835-C6
SLI-2835-C8	SLO-2835-C8
Stainless Steel Joints with Stainless Steel Uprights	
SLI-2835-A6S	SLO-2835-A6S
SLI-2835-C6S	SLO-2835-C6S
SLI-2835-C8S	SLO-2835-C8S
Titanium Joints with Aluminum Uprights	
TISLI-2835-A6	TISLO-2835-A6
TISLI-2835-C6	TISLO-2835-C6
TISLI-2835-C8	TISLO-2835-C8
Titanium Joints with Stainless Steel Uprights	
TISLI-2835-A6S	TISLO-2835-A6S
TISLI-2835-C6S	TISLO-2835-C6S
TISLI-2835-C8S	TISLO-2835-C8S



Model SLI/SLO-2825 – Slim Line Double Action Ankle Joints

- All units include bushing, screw, ball bearings, springs, and hex set screws; sold individually
- “A” size joints = $\frac{3}{8}$ ” bushing hole; “C” size joints = $\frac{5}{16}$ ” bushing hole; “A” joints are used with A and B stirrups
- “C8” joints are compatible with our “A” and “B” stirrups

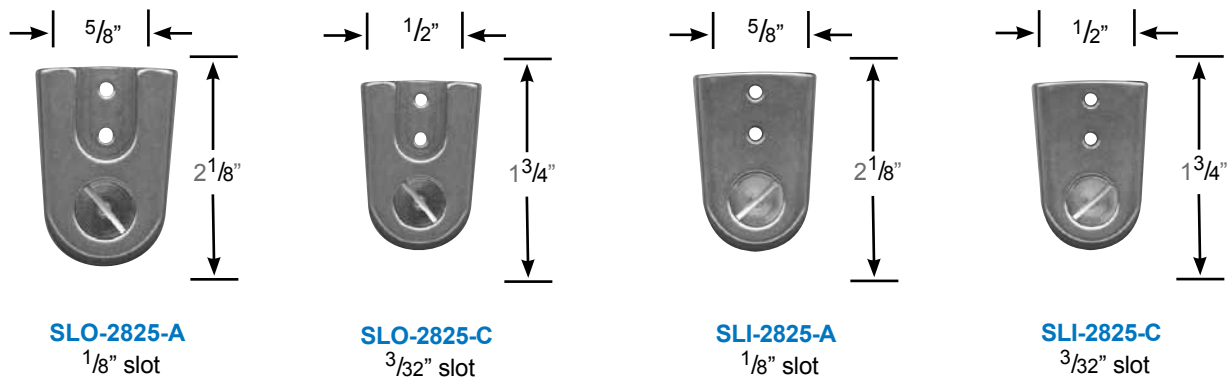

Model TISLI/TISLO-2825 – Titanium Slim Line Double Action Ankle Joints

- The lightest DA joint from Becker
- All units include bushing, screw, ball bearings, springs, and hex set screws; sold individually
- “A” size joints = $\frac{3}{8}$ ” bushing hole; “C” size joints = $\frac{5}{16}$ ” bushing hole; “A” joints are used with A and B stirrups

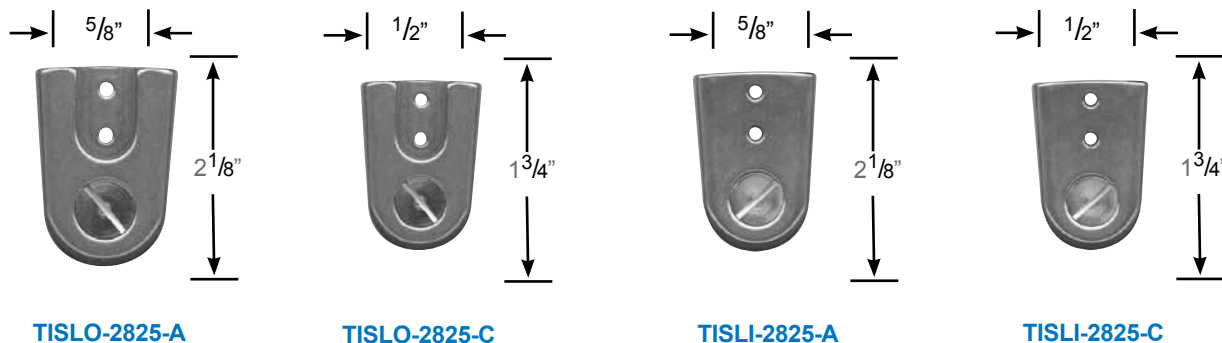

* All A joints listed above have a $\frac{1}{8}$ ” slot, all C joints have a $\frac{5}{32}$ ” slot

Model SLM-2825 – Slim Line Modular Ankle Joint

- Available in stainless steel or aluminum
- Available in “A” or “B” size
- $\frac{3}{4}$ ” recess for “A” size
- $\frac{5}{8}$ ” recess for “B” size



Description	Product No.
Slim Line Modular Ankle Joint (A size)	SLM-2825-A
Slim Line Modular Ankle Joint (B size)	SLM-2825-B

Model SL2845-A – Slim Line One-Piece Aluminum Double Action Ankle Joint and Upright

- Sold individually, with or without pin
- Fits Stirrup Size: Adult or Youth
- Upright Dimension: $\frac{3}{16}$ ” x $\frac{5}{8}$ ” x 14”

Description	Product No.
Slim Line Ankle Joint (without pin)	SL2845-A
Slim Line Ankle Joint (with pin)	SL2845-A W/PIN

Model 2960 – Original Double Action Split Stirrups

- Split stirrup upright only; sold individually

Size	Upright Dimension	Product No.
Child	$\frac{3}{32}$ ” x $\frac{11}{16}$ ”	2960-C
Youth	$\frac{1}{8}$ ” x $\frac{3}{4}$ ”	2960-B
Adult	$\frac{1}{8}$ ” x $\frac{7}{8}$ ”	2960-A

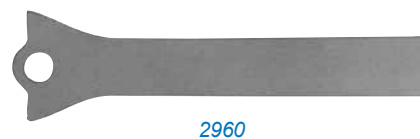

Ankle Joints
and Stirrups

ANKLE JOINTS AND STIRRUPS

Model SL2960 – Slim Line Split Stirrup - Upright Only

- Sold individually

Size	Upright Dimension	Product No.
Child	$3/32" \times 11/16"$	SL2960-C
Youth	$1/8" \times 3/4"$	SL2960-B
Adult	$1/8" \times 7/8"$	SL2960-A



SL2960

Model SL2964-X – Slim Line Split Stirrup Uprights with Wide Flange Caliper Plate

Size	Left	Product No.	
		Right	Pair
Youth	SL2964-XBL	SL2964-XBR	SL2964-XBP
Adult	SL2964-XAL	SL2964-XAR	SL2964-XAP



Model SL2800 – Stance Control Stirrup/Wide Long Double Action

- Designed to connect directly to the FullStride knee cabling system
- No longer necessary to use the heel cable receptor that comes with the stance control system

Description	Product No.
Stance Control Stirrup	SC-SL2800-X9
Stance Control Stirrup	SC-SL2800-X10
Stance Control Stirrup	SC-SL2800-X11
Stance Control Y Stirrup	SC-SL2810-A-Y



Model SL2810 – Slim Line Stirrup Insert Only

- One-piece with a generous radius at the attachment portion and upright extension interface
- Configuration and absence of welding makes it extremely strong

Size	Length	Thickness	Product No.
Child	$1\frac{4}{5}"$	$3/32"$	SL2810.C1.8
Child	2"	$3/32"$	SL2810.C2.0
Child	$2\frac{3}{10}"$	$3/32"$	SL2810.C2.3
Adult	$2\frac{1}{4}"$	$1/8"$	SL2810.A2.25
Adult	$2\frac{1}{2}"$	$1/8"$	SL2810.A2.5
Adult	$2\frac{3}{4}"$	$1/8"$	SL2810.A2.75
Adult	3"	$1/8"$	SL2810.A3



Model SL2810Y – Slimline Y Stirrup Insert Only

- The “Y” shaped flanges are preferred by many orthotists

Size	X	Y	Thickness	Product No.
Child	3.36”	2.30”	³ / ₃₂ ”	SL2810-C-Y
Adult	3.31”	2.61”	¹ / ₈ ”	SL2810-A-Y

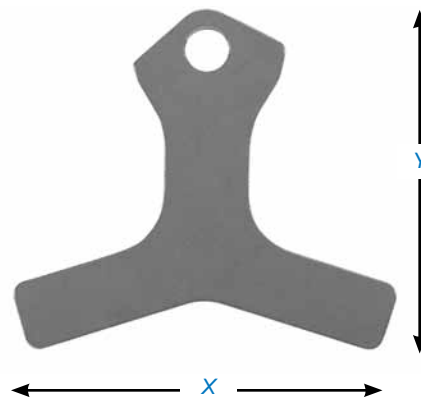

Ankle Joints
and Stirrups

SL2900 Series – Slim Line Standard Flange Stirrup

- Recommended where a light weight double action stirrup is required
- Adult and Youth: ¹/₈” stainless steel; two ³/₈” bushing holes, adult has a 3¹/₂” tongue, youth has a 2⁴/₅” tongue
- Child: ³/₃₂” stainless steel; two ⁵/₁₆” bushing holes, 2¹/₁₀” tongue

Size	Length	Product No.
Child	4 ¹ / ₂ ”	SL2900-C4.5
Child	5 ¹ / ₄ ”	SL2900-C5.25
Child	6”	SL2900-C6
Child	6 ³ / ₄ ”	SL2900-C6.75
Youth	6 ³ / ₄ ”	SL2900-B6.75
Youth	7 ¹ / ₂ ”	SL2900-B7.5
Youth	8 ¹ / ₄ ”	SL2900-B8.25
Youth	9”	SL2900-B9
Adult	8”	SL2900-A8
Adult	8 ¹ / ₂ ”	SL2900-A8.5
Adult	9”	SL2900-A9
Adult	9 ¹ / ₂ ”	SL2900-A9.5
Adult	10”	SL2900-A10
Adult	10 ¹ / ₂ ”	SL2900-A10.5
Adult	11”	SL2900-A11
Adult	11 ¹ / ₂ ”	SL2900-A11.5



Standard Action

CODE CHART

Each configuration has a code letter which you must list after the order number if you want the head ground for you. For example, if you wanted an adult 8 inch stirrup the order number would be 3000-A8. If you wanted free motion you would add the code letter "F" after the order number: 3000-A8F. If you make no designation for motion, a stiff ankle will be provided, since this can be made into any of the other four configurations.



**STIFF ANKLE
NO CODE
LETTER**

No dorsi or plantar flexion.



**LIMITED MOTION
CODE LETTER "L"**

Head allows approximately 3 degrees of dorsi and plantar flexion.



**FREE MOTION
CODE LETTER "F"**

Head allows full range-of-motion.



**EQUINUS STOP
CODE LETTER "E"**

Head allows full range of dorsiflexion and no plantar flexion.



**CALCANEUS STOP
CODE LETTER "C"**

Head allows full range of plantar flexion and no dorsiflexion.

3000 Series – Standard Flange Stirrup Only

- Please specify code letter from the above chart if motion other than stiff ankle is desired
- Child: $\frac{3}{32}$ " stainless steel; two $\frac{5}{16}$ " bushing holes
- Adult = $3\frac{1}{2}$ " tongue, Youth = $2\frac{4}{5}$ " tongue, Child = $2\frac{1}{10}$ " tongue
- Adult and Youth: $\frac{1}{8}$ " stainless steel; two $\frac{3}{8}$ " bushing holes



Size	Length	Product No.
Model 3000-C Child Stirrup Only		
Child	4 $\frac{1}{2}$ "	3000-C4.5
Child	5 $\frac{1}{4}$ "	3000-C5.25
Child	6"	3000-C6
Child	6 $\frac{3}{4}$ "	3000-C6.75
Model 3000-B Youth Stirrup Only		
Youth	6 $\frac{3}{4}$ "	3000-B6.75
Youth	7 $\frac{1}{2}$ "	3000-B7.5
Youth	8 $\frac{1}{4}$ "	3000-B8.25
Youth	9"	3000-B9
Model 3000-A Adult Stirrup Only		
Adult	8"	3000-A8
Adult	8 $\frac{1}{2}$ "	3000-A8.5
Adult	9"	3000-A9
Adult	9 $\frac{1}{2}$ "	3000-A9.5
Adult	10"	3000-A10
Adult	10 $\frac{1}{2}$ "	3000-A10.5
Adult	11"	3000-A11

3000 Series – Wide Flange Stirrup Only

- May be used with any Standard Action ankle joint
- Three configurations: each made from 1/8" stainless steel with two 3/8" bushing holes
- W3000 is a standard wide flange stirrup with 4 1/2" tongue
- X3000 is the same as Model W3000 with 6" tongue for increased stability
- SX3000 has a unique web configuration and an extended tongue (7")

Length	Product No.		
	W3000	X3000	SX3000
8"	W3000-A8	X3000-A8	SX3000-A8
8 1/2"	W3000-A8.5	X3000-A8.5	SX3000-A8.5
9"	W3000-A9	X3000-A9	SX3000-A9
9 1/2"	W3000-A9.5	X3000-A9.5	SX3000-A9.5
10"	W3000-A10	X3000-A10	SX3000-A10
10 1/2"	W3000-A10.5	X3000-A10.5	SX3000-A10.5
11"	W3000-A11	X3000-A11	SX3000-A11



Ankle Joints
and Stirrups

Ankle Code Chart

Code Letter Suffix	Description
No code letter	Stiff Ankle
L	Limited Motion
F	Free Motion
E	Equinus Stop
C	Calcaneus Stop
Example: Free Motion Ankle - 3010-A2.25F	

Model 3010 – Stirrup Insert Only

- Please specify code letter from the Ankle Code Chart if motion other than stiff ankle is desired
- One-piece stirrup insert with a generous radius at the attachment portion and upright extension interface
- Configuration and absence of welding makes it extremely strong
- Sold individually

Length	Product No.	
	Joint Size A	Joint Size C
1 3/4"	—	3010-C1.8
2"	—	3010-C2.0
2 1/4"	3010-A2.25	—
2.3"	—	3010-C2.3
2 1/2"	3010-A2.5	—
2 3/4"	3010-A2.75	—
3"	3010-A3	—



Model 3025 – Standard Action Ankle Joints

- Manufactured in five sizes
- 303 stainless steel construction

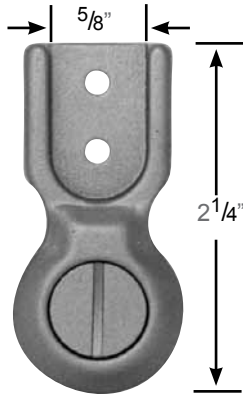

3025-A

Adult size

$\frac{3}{8}$ " bushing hole and $\frac{1}{8}$ " slot
Accepts $\frac{5}{8}$ " uprights

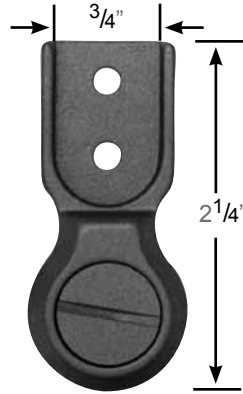

3025-AW

Adult size

$\frac{3}{8}$ " bushing hole and $\frac{1}{8}$ " slot
Accepts $\frac{3}{4}$ " uprights



3025-B

Youth size

$\frac{3}{8}$ " bushing hole and $\frac{1}{8}$ " slot
Accepts $\frac{5}{8}$ " uprights

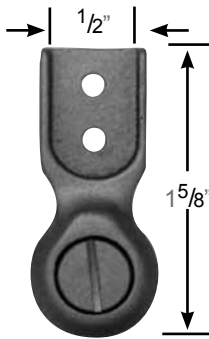

3025-C

Child size

$\frac{5}{16}$ " bushing hole and $\frac{3}{32}$ " slot
Accepts $\frac{1}{2}$ " uprights

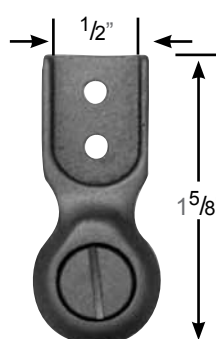

3025-C8

Child size

$\frac{5}{16}$ " bushing hole
and $\frac{1}{8}$ " slot



3A

3B

To order parts, specify the order number of the joint, followed by the product number you desire.

Model M3025 – Standard Action Modular Ankle Joint

- Available in "Youth" or "Adult" size

Size	Recess	Product No.
Youth	$\frac{5}{8}$ "	M3025-B
Adult	$\frac{3}{4}$ "	M3025-A



Model 3035 – Standard Action Ankle Joint with Attached Upright

- Sold individually

Size	Upright Material	Upright Dimension	Product No.
Child	Aluminum	3/16" x 1/2" x 11"	3035-C6
Child	Aluminum	1/8" x 1/2" x 11"	3035-C8
Child	Stainless Steel	3/16" x 1/2" x 11"	3035-C6S
Child	Stainless Steel	1/8" x 1/2" x 11"	3035-C8S
Child	Stainless Steel	1/8" x 1/2" x 11"	3035-I8S
Youth	Aluminum	1/4" x 5/8" x 15 1/8"	3035-B4
Youth	Aluminum	3/16" x 5/8" x 15 1/8"	3035-B6
Youth	Aluminum	1/8" x 5/8" x 15 1/8"	3035-B8
Youth	Stainless Steel	3/16" x 5/8" x 15 1/8"	3035-B6S
Youth	Stainless Steel	5/32" x 5/8" x 15 1/8"	3035-B2S
Adult	Aluminum	1/4" x 3/4" x 15 1/4"	W3035-A4
Adult	Aluminum	3/16" x 3/4" x 15 1/4"	W3035-A6
Adult	Stainless Steel	3/16" x 3/4" x 15 1/4"	W3035-A6S
Adult	Aluminum	1/4" x 5/8" x 15 1/4"	3035-A4
Adult	Aluminum	3/16" x 5/8" x 15 1/4"	3035-A6
Adult	Aluminum	1/8" x 5/8" x 15"	3035-A8
Adult	Stainless Steel	3/16" x 5/8" x 15 1/4"	3035-A6S
Adult	Stainless Steel	5/32" x 5/8" x 15 1/4"	3035-A2S



3035-A

Ankle Joints
and Stirrups

Model 3045 – One Piece Aluminum Standard Action Ankle Joint and Upright

- Machined from 7075-T6 aluminum bar
- Sold individually

Size	Upright Dimensions	Product No.
Child	3/16" x 1/2" x 7 7/8"	3045-C
Youth	3/16" x 5/8" x 16"	3045-B
Adult	3/16" x 5/8" x 16"	3045-A



3045-A

Model 3060 – Split Stirrup Upright Only

- Sold individually

Size	Upright Dimensions	Product No.
Child	3/32" x 1 1/16"	3060-C
Youth	1/8" x 3/4"	3060-B
Adult	1/8" x 7/8"	3060-A



ANKLE JOINTS AND STIRRUPS

Model 3064-X – Split Stirrup Upright with Wide Flange Caliper Plate

Size	Left Foot	Product No.	
		Right Foot	Pair
Youth	3064-XBL	3064-XBR	3064-XBP
Adult	3064-XAL	3064-XAR	3064-XAP



Dorsiflexion Assist

3200 Series – Standard Flange Stirrup Only

- Designed to allow a limited amount of plantarflexion in addition to dorsiflexion assist
- Child: $\frac{3}{32}$ " stainless steel; two $\frac{5}{16}$ " bushing holes
- Adult and Youth: $\frac{1}{8}$ " stainless steel; two $\frac{3}{8}$ " bushing holes

Size	Length	Product No.
Model 3200-C Child Stirrup Only 2.1" tongue		
Child	4 $\frac{1}{2}$ "	3200-C4.5
Child	5 $\frac{1}{4}$ "	3200-C5.25
Child	6"	3200-C6
Child	6 $\frac{3}{4}$ "	3200-C6.75
Model 3200-B Youth Stirrup Only 2.8" tongue		
Youth	6 $\frac{3}{4}$ "	3200-B6.75
Youth	7 $\frac{1}{2}$ "	3200-B7.5
Youth	8 $\frac{1}{4}$ "	3200-B8.25
Youth	9"	3200-B9
Model 3200-A Adult Stirrup Only 3.5" tongue		
Adult	8"	3200-A8
Adult	8 $\frac{1}{2}$ "	3200-A8.5
Adult	9"	3200-A9
Adult	9 $\frac{1}{2}$ "	3200-A9.5
Adult	10"	3200-A10
Adult	10 $\frac{1}{2}$ "	3200-A10.5
Adult	11"	3200-A11
Adult	11 $\frac{1}{2}$ "	3200-A11.5



3200 Series – Wide Flange Stirrup Only

- To be utilized with any of our dorsiflexion assist ankle joints for increased stability
- Three configurations: each made from 1/8" stainless steel with two 3/8" bushing holes
- W3200 is a standard wide flange stirrup with 4 1/2" tongue
- X3200 is the same as W3000 with 6" tongue for increased stability
- SX3200 has a unique web configuration and extended tongue (7")

Length	Product No.		
	W3200	X3200	SX3200
8"	W3200-A8	X3200-A8	SX3200-A8
8 1/2"	W3200-A8.5	X3200-A8.5	SX3200-A8.5
9"	W3200-A9	X3200-A9	SX3200-A9
9 1/2"	W3200-A9.5	X3200-A9.5	SX3200-A9.5
10"	W3200-A10	X3200-A10	SX3200-A10
10 1/2"	W3200-A10.5	X3200-A10.5	SX3200-A10.5
11"	W3200-A11	X3200-A11	SX3200-A11
11 1/2"	W3200-A11.5	—	—



W3200



X3200



SX3200

Ankle Joints
and Stirrups

Model 3210 – Dorsiflexion Assist Stirrup Insert

- One-piece with a generous radius at the attachment portion and upright extension interface
- Configuration and absence of welding makes it extremely strong
- Thickness: Size A - 1/8"; Size C - 3/32"

Length	Product No.	
	Joint Size A	Joint Size C
2"	—	3210-C2.0
2 1/4"	3210-A2.25	—
2.3"	—	3210-C2.3
2 1/2"	3210-A2.5	—
2 3/4"	3210-A2.75	—
3"	3210-A3	—



Model 3210-Y – Dorsiflexion Assist Y Stirrup Insert

- The "Y" shaped flanges are preferred by many orthotists

Size	Joint Size	Thickness	Length	Product No.
Child	C	3/32"	2.3"	3210-C-Y
Adult	A & B	1/8"	2.61"	3210-A-Y



3225 Series – Dorsiflexion Assist Ankle Joint Units

- Made from 303 stainless steel
- “A” Adult dorsiflexion assist ankle joint with $\frac{3}{8}$ ” bushing hole and $\frac{1}{8}$ ” slot, accepts $\frac{5}{8}$ ” uprights
- “B” Youth dorsiflexion assist ankle joint with $\frac{3}{8}$ ” bushing hole and $\frac{1}{8}$ ” slot, accepts $\frac{5}{8}$ ” uprights
- “C” Child dorsiflexion assist ankle joint with $\frac{5}{16}$ ” bushing hole and $\frac{3}{32}$ ” slot, accepts $\frac{1}{2}$ ” uprights
- “C8” Child size dorsiflexion assist ankle joint with $\frac{5}{16}$ ” bushing hole and $\frac{1}{8}$ ” slot; Used with “A” or “B” size stirrups and 3870 bushing adapter ring

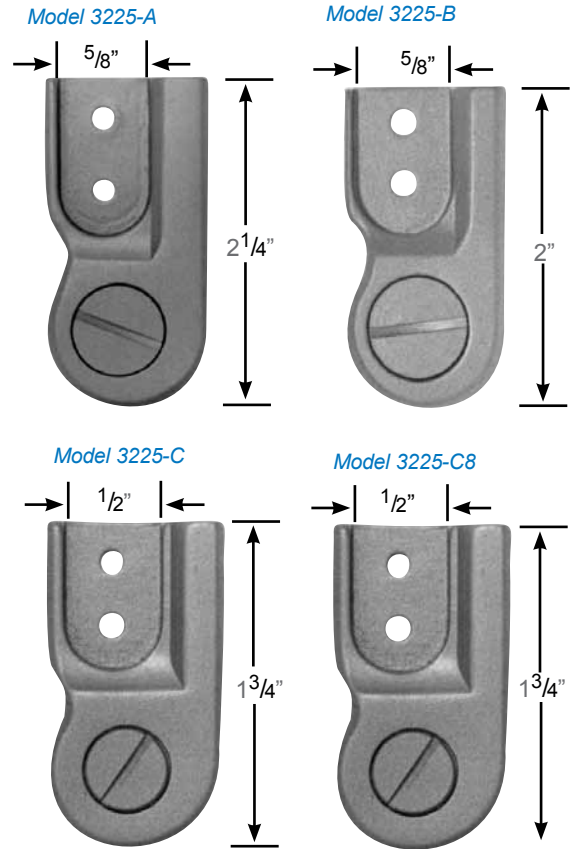

Side	Product No.			
	“A”	“B”	“C”	“C8”
Left	3225-AL	3225-BL	3225-CL	3225-C8L
Right	3225-AR	3225-BR	3225-CR	3225-C8R
Pair	3225-A-P	3225-B-P	3225-CP	3225-C8P

Model 3235 – Dorsiflexion Assist Ankle Joint with Attached Upright

Size	Upright Material	Upright Dimensions	Pair	Product No.	
				Left	Right
Child	Round Edge Aluminum	$\frac{3}{16}$ ” x $\frac{1}{2}$ ” x 11”	—	3235-C6-L	3235-C6-R
Child	Round Edge Aluminum	$\frac{1}{8}$ ” x $\frac{1}{2}$ ” x 11”	—	3235-C8-L	3235-C8-R
Child	Stainless Steel	$\frac{3}{16}$ ” x $\frac{1}{2}$ ” x 11”	—	3235-C6S-L	3235-C6S-R
Child	Stainless Steel	$\frac{1}{8}$ ” x $\frac{1}{2}$ ” x 11”	—	3235-C8S-L	3235-C8S-R
Youth	Round Edge Aluminum	$\frac{1}{4}$ ” x $\frac{5}{8}$ ” x $15\frac{1}{8}$ ”	—	3235-B4-L	3235-B4-R
Youth	Round Edge Aluminum	$\frac{3}{16}$ ” x $\frac{5}{8}$ ” x $15\frac{1}{8}$ ”	3235-B6-P	3235-B6-L	3235-B6-R
Youth	Round Edge Aluminum	$\frac{1}{8}$ ” x $\frac{5}{8}$ ” x $15\frac{1}{8}$ ”	—	3235-B8-L	3235-B8-R
Youth	Stainless Steel	$\frac{3}{16}$ ” x $\frac{5}{8}$ ” x $15\frac{1}{8}$ ”	—	3235-B6S-L	3235-B6S-R
Youth	Stainless Steel	$\frac{5}{32}$ ” x $\frac{5}{8}$ ” x $15\frac{1}{8}$ ”	—	3235-B2S-L	3235-B2S-R
Adult	Round Edge Aluminum	$\frac{1}{4}$ ” x $\frac{5}{8}$ ” x $15\frac{1}{4}$ ”	3235-A4-P	3235-A4-L	3235-A4-R
Adult	Round Edge Aluminum	$\frac{3}{16}$ ” x $\frac{5}{8}$ ” x $15\frac{1}{4}$ ”	3235-A6-P	3235-A6-L	3235-A6-R
Adult	Round Edge Aluminum	$\frac{1}{8}$ ” x $\frac{5}{8}$ ” x $15\frac{1}{4}$ ”	—	3235-A8-L	3235-A8-R
Adult	Stainless Steel	$\frac{3}{16}$ ” x $\frac{5}{8}$ ” x $15\frac{1}{4}$ ”	3235-A6S-P	3235-A6S-L	3235-A6S-R
Adult	Stainless Steel	$\frac{5}{32}$ ” x $\frac{5}{8}$ ” x $15\frac{1}{8}$ ”	3235-A2S-P	3235-A2S-L	3235-A2S-R

Model C8 and C8S come equipped with 3225-C ankle joint



Model 3245 – One-Piece Aluminum Dorsiflexion Assist Ankle Joint and Upright

- This model is made from drop-forged aluminum
- One-piece construction is lightweight without sacrificing strength
- “Adult” size fits both “A” and “B” stirrups

Size	Dimension	Left	Product No.		Pair
			Right		
Child	3/16" x 1/2" x 10 1/2"	3245-CL	3245-CR	3245-CP	
Adult or Youth	3/16" x 5/8" x 16 1/2"	3245-AL	3245-AR	3245-AP	



Ankle Joints
and Stirrups

Model 3260 – Dorsiflexion Assist Split Stirrup Upright Only

Size	Upright Dimensions	Product No.
Child	3/32" x 11/16"	3260-C
Youth	1/8" x 3/4"	3260-B
Adult	1/8" x 7/8"	3260-A



X3200-A – Dorsiflexion PLUS Stirrup

- Designed for patients requiring a stronger dorsiflexion assist action
- The extended spring provides a very smooth movement
- Interchangeable with other major brands
- 3 1/2" tongue

Length	Product No.
8"	X3200-A8
8 1/2"	X3200-A8.5
9"	X3200-A9
9 1/2"	X3200-A9.5
10"	X3200-A10
10 1/2"	X3200-A10.5
11"	X3200-A11
11 1/2"	X3200-A11.5



X3200-A

X3210-A – Dorsiflexion PLUS Stirrup Insert

- One-piece with a generous radius at the attachment portion and upright extension interface, 1/8" thickness

Measurements		Product No.
X	Y	
3"	2 1/4"	X3210-A2.25
3"	2 1/2"	X3210-A2.5
3"	2 3/4"	X3210-A2.75
3"	3"	X3210-A3

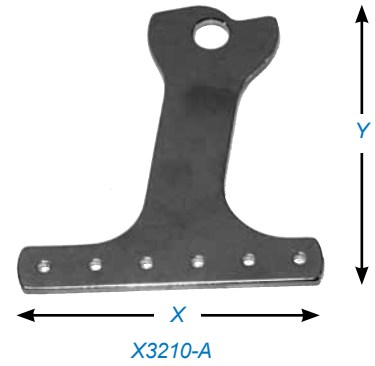

X3210-A-Y – Dorsiflexion PLUS Y Stirrup Insert

- The "Y" shaped flanges are preferred by many orthotists
- 1/8" thickness

Measurements		Product No.
X	Y	
3.31"	2.61"	X3210-A-Y

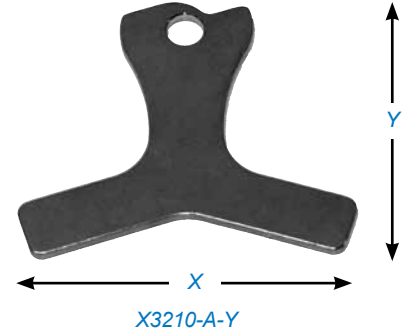

X3245-A – One-Piece Aluminum Dorsiflexion PLUS Ankle Joint and Upright

- Made from drop-forged aluminum or anodized aluminum
- One-piece construction; lightweight without sacrificing strength
- Interchangeable with other brands
- Dimensions: 3/16" x 5/8" x 17 1/8"

Description	Product No.		Pair
	Left	Right	
Plain Aluminum	X3245-AL	X3245-AR	X3245-A-P
Anodized Aluminum	AX3245-AL	AX3245-AR	—

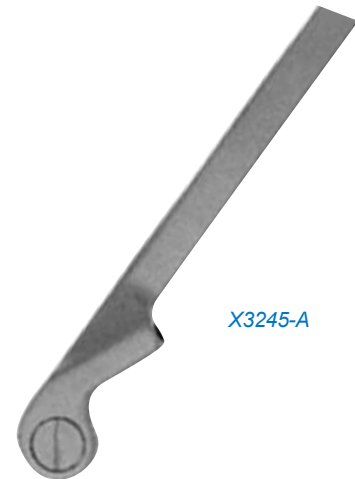

X3260 – Dorsiflexion PLUS Split Stirrup Upright

- Sold each

Size	Upright Dimension	Product No.
Adult	1/8" x 7/8"	X3260-A



Scott Craig Stirrup Strut

- Developed for use in paraplegia orthoses
- Can be shaped and welded to any stirrup to provide increased strength and stability

Product No. **SC-30**



Caliper Systems

3400 – Split Stirrup Caliper Plate

- Child plate made from .075" stainless steel
Youth caliper plate made from .090" stainless steel
Adult caliper plate made from .090" stainless steel
- Child: $\frac{3}{32}$ " x $\frac{11}{16}$ " channel dimension, $2\frac{3}{8}$ " wide, $2\frac{1}{2}$ " tongue
- Youth: $\frac{1}{8}$ " x $\frac{3}{4}$ " channel dimension, $2\frac{7}{8}$ " wide, $3\frac{1}{8}$ " tongue
- Adult: $\frac{1}{8}$ " x $\frac{7}{8}$ " channel dimension, $3\frac{1}{4}$ " wide, 4" tongue

Size	Left	Product No.	
		Right	Pair
Child	3400-CL	3400-CR	3400-CP
Youth	3400-BL	3400-BR	3400-BP
Adult	3400-AL	3400-AR	3400-AP



3400

3400-X – Wide Flange Split Stirrup Caliper Plate

- Youth wide flange plate made from .090" stainless steel
Adult wide flange plate made from .090" stainless steel
- Youth $\frac{1}{8}$ " x $\frac{3}{4}$ " channel dimension, $3\frac{3}{8}$ " wide, $6\frac{7}{8}$ " tongue
- Adult $\frac{1}{8}$ " x $\frac{7}{8}$ " channel dimension, $3\frac{3}{4}$ " wide, $6\frac{7}{8}$ " tongue

Size	Left	Product No.	
		Right	Pair
Youth	3400-XBL	3400-XBR	3400-XBP
Adult	3400-XAL	3400-XAR	3400-XAP



3400-X

3500 Series – Free Motion Caliper Plates and Attachments

- All plates and tubing are stainless
- Upright attachments are polished cold rolled steel
- Plate only
- "B" Tubing width = $2\frac{3}{4}$ ", $2\frac{3}{4}$ " tongue
- "A" Tubing width = $3\frac{1}{4}$ ", $3\frac{1}{2}$ " tongue

Tube ID Size	Left	Product No.	
		Right	Pair
B - $\frac{1}{4}$ "	3500-BL	3500-BR	3500-BP
A - $\frac{5}{16}$ "	3500-AL	3500-AR	3500-AP



3500-A

3515 – Caliper Pin

Pin Diameter	Product No.
B - $\frac{1}{4}$ "	3515-B
A - $\frac{5}{16}$ "	3515-A



3515-A

Model 3525 – Upright Attachment with Caliper Pin

Pin Diameter	Upright Recess	Product No.
B - 1/4"	1/2"	3525-B
A - 5/16"	5/8"	3525-A



3525-A

Fillauer - Short Leg Upright Ankle Joint Assemblies

- Aluminum
- Sold individually

Limited Motion Ankle Joint

Size	Product No.
Medium	020514
Large	020515



020514

Free Motion Ankle Joint

Size	Product No.
Small	020509
Medium	020510
Large	020511



020502

Toe Pick Up

Size	Product No.	
	Left	Right
Small	020501	020500
Medium	020503	020502
Large	020506	020504

Double Action Ankle Joint

Size	Product No.
Large	020518
Large with Position Pins	020519



020518

Double Action Ankle Joint Assembly

- Stainless steel
- All have openings for a 5/8" wide bar or 3/4"
- Sold individually

Description	Product No.
5/8" Channel Large	020882
With Threaded Pins, 5/8" Channel Large	020884
3/4" Channel Large	020886
With Positioning Pins Large	020888



Lively Orthosis Assembly Kit

- 3/8" minimum clearance at malleoli

Size	For Ankle Diameter	Product No.
X-Small	up to 2"	072074
Small	2 1/16" - 2 1/4"	072082
Medium	2 5/16" - 2 1/2"	072090
Large	2 9/16" - 2 3/4"	072108
X-Large	2 13/16" - 3 1/4"	072116



Ankle Joints
and Stirrups

Stainless Steel, Polished Ankle Joint Bar

- Adjustable length ankle bar with 1/4" diameter tubular rivet
- Sold individually
- 1/8" x 1/2" x 5"

Description	Product No.
Ankle Joint Bar	020529
Rivet	886101



Adjustment Clip

- Sold individually
- Stainless steel, polished

Width	Product No.
1/2"	020479
5/8"	020461
3/4"	020453



Adjustable Extension Bar

- Stainless steel, polished
- Sold individually

Size	Tapped Holes	Product No.
1/8" x 1/2" x 6"	5	020446
1/8" x 5/8" x 7"	6	020438
1/8" x 3/4" x 8"	6	020420



Insert Stirrups

- Stainless steel polished
- 1¹/₈" head size
- Sold as pair

Size	Product No.	
	Limited Motion	Toe Lift
2 ⁵ / ₁₆ "	020099	020123
2 ³ / ₄ "	020115	020149



Insert Stirrups with Offset

- Stainless steel polished
- 1¹/₈" head size
- Sold as pair

Size	Product No.	
	Limited Motion	Toe Lift
2 ¹ / ₄ " x 3 ³ / ₈ "	020016	020057
2 ¹ / ₄ " x 1 ¹ / ₂ "	020024	020065
2 ¹ / ₂ " x 3 ³ / ₈ "	020032	020073
2 ¹ / ₂ " x 1 ¹ / ₂ "	020040	020081



Rectangular Caliper Plates

- Zinc plated
- Sold individually

Size	Product No.	
	Left	Right
1 ¹ / ₈ " x 5 ⁵ / ₈ " x 3 ¹ / ₂ "	020248	020230
1 ¹ / ₈ " x 3 ³ / ₄ " x 3 ³ / ₄ "	020263	020255
1 ¹ / ₈ " x 7 ⁷ / ₈ " x 4"	020289	020271



Spring Wire Dorsiflexion Assist Orthosis Kit

- Each kit consists of an 18" spring wire and foot plate; stainless steel
- Shoe plate only: 012003

Size	Wire Diameter	Heel Width	Product No.
Small	1 ¹ / ₈ "	2 ⁵ / ₈ "	012000KT
Medium	5 ⁵ / ₃₂ "	3"	012001KT
Large	5 ⁵ / ₃₂ "	3 ¹ / ₂ "	012002KT



Wide Tongue LM/FM

- Sold each

Size	Product No.
Large, 8 ³ / ₄ "	010849
Large, 9 ¹ / ₂ "	010850
Large, 10 ¹ / ₄ "	010851

Wide Tongue Double Action

- Sold each

Size	Product No.
Large, 8 ³ / ₄ "	010852
Large, 9 ¹ / ₂ "	010853
Large, 10 ¹ / ₄ "	010854

Wide Tongue Toe Pick Up

- Sold each

Size	Product No.
Large, 8 ³ / ₄ "	010846
Large, 9 ¹ / ₂ "	010847
Large, 10 ¹ / ₄ "	010848

Split Double Action

- Sold each

Size	Product No.
Small, 3/32" x 1/2"	010874
Small, 3/32" x 5/8"	010875
Large, 1/8" x 5/8"	010871
Large, 1/8" x 3/4"	010872
Large, 1/8" x 7/8"	010873

Double Action Ankle Joint

- Available straight and contoured
- 5/8" or 3/4" channels
- Side bars are press-fit and secured in corresponding channels with supplied screws

Channel Size	Product No.	
	Contoured	Straight
5/8"	71202	71204
3/4"	71200	71201

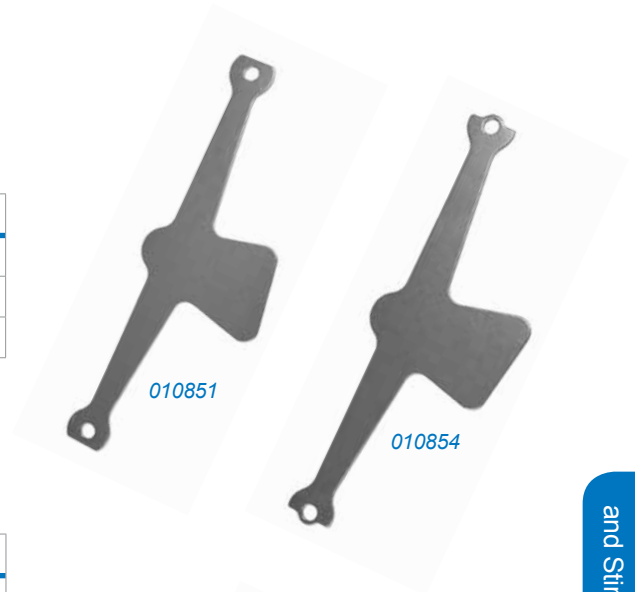

Double Action Ankle Joint with Pin (not pictured)

- For situations where positive adjustment of dorsiflexion or plantar flexion is required
- Note: General use is contoured/medial and straight/lateral

Channel Size	Product No.	
	Contoured	Straight
5/8"	71315	71313
3/4"	71316	71314

Ankle Joint Component Parts	
Description	Product No.
Spring for Dorsiflexion Ankle Joint	72055
Spring for Double Action Ankle Joint	72062

Stirrup Foot Plate

- Stainless Steel, welded and channeled to receive 1/8" x 7/8" caliper stirrups
- Embossed foot plates with reference point to indicate intersection of lines through tongue and head centers

Side	Product No.
Left	71143
Right	71142

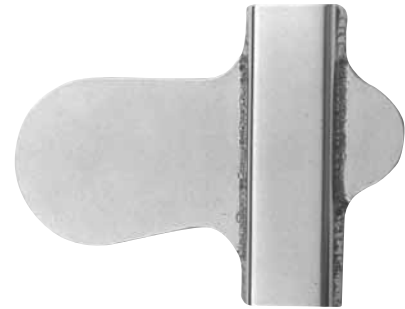

Laurence Manufacturing - Stirrups

- Sold as a pair

Description	Product No.
Stirrups, Adult	
Limited Motion	0100
Klenzak	0200
Double Action	0300
Stirrups, Child, 3/32" Stainless Steel	
Limited Motion	0400L
Klenzak	0500L
Double Action	0600L
Stirrups, Child, 1/8" Stainless Steel	
Limited Motion	0400H
Klenzak	0500H
Double Action	0600H



OTS - Thermoformable Integrated Ankle

- Available in three range of control motions:
 - Double Action
 - Dorsiflexion Assist
 - Adjustable Range-of-Motion
- Includes split tail stirrups and mounting hardware with each device
- CNC machined proprietary alloy is 66% lighter than steel

Size	Double Action	Dorsiflexion Assist
Child	IACHDA-AL	IACHDF-AL
Youth	IAYTHDA-AL	IAYTHDF-AL
Adult	IAADDA-AL	IAADDF-AL

Size	Adjustable Range-of-Motion
Small	IASMARM-AL
Large	IALGARM-AL

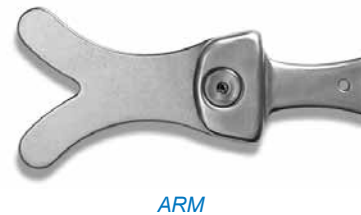
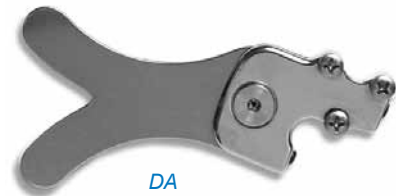

Ankle Joints
and Stirrups

Traditional Integrated Ankle

- Available in two range of control motions:
 - Double Action
 - Adjustable Range-of-Motion
- CNC machined proprietary alloy is 66% lighter than steel
- Accepts both solid stirrup or split tail
- Sold in pairs; joint only with bar slot

Slot Size	Barstock Size	Material	Product No.	
			Double Action	Adjustable Range-of-Motion
1/2"	3/16" x 1/2"	Steel	IA12-EU	IA12ARM-EU
1/2"	3/16" x 1/2"	Aluminum	IA12-AL-EU	IA12ARM-AL-EU
5/8"	3/16" x 5/8"	Steel	IA16-EU	IA16ARM-EU
5/8"	1/4" x 5/8"	Aluminum	IA16-AL-EU	IA16ARM-AL-EU
3/4"	3/16" x 3/4"	Steel	IA19	IA19ARM
3/4"	1/4" x 3/4"	Aluminum	IA19-AL	IA19ARM-AL



Split Tail Stirrups

Size	Double Action	Dorsiflexion Assist
Child	IARCHDAST	IARCHDFST
Youth	IARYTHDAST	IARYTHDFST
Adult	IARADDAST	IARADDST



Solid Stirrups

- One head configuration
- Double Action and Adjustable Range-of-motion use the same style head

Size	Dimensions	Product No.
Child-Small	6 ¹ / ₂ "	STWTDA6.5-CH
Child-Small	7 ¹ / ₄ "	STWTDA7.25-CH
Child-Small	8"	STWTDA8-CH
Child-Small	8 ³ / ₄ "	STWTDA8.75
Adult-Large	9 ¹ / ₂ "	STWTDA9.5
Adult-Large	10 ¹ / ₄ "	STWTDA10.25
Adult-Large	11	STWTDA11



Trulife - Upright with Ankle Joint for Toe Lift (POPE)

- Sold individually
- Single upright

Size	Metal	Product No.	
		Left	Right
Infant	Aluminum	018007	018012
Child	Aluminum	018041	018046
Adult	Aluminum	018075	018080



Extension Upright with Ankle Joint for Toe Lift (POPE)

- Sold individually

Size	Metal	Product No.	
		Left	Right
Child	3/16" x 5/8" x 9"	023001	023006
Adult	1/4" x 3/4" x 9"	023011	023016



Upright with Ankle Joint for Limited and Free Motion (POPE)

- Single upright
- Sold individually

Description	Metal	Product No.		
		Infant	Child	Adult
Limited motion	Aluminum	018113	018130	018147
Free motion	Aluminum	018162	018173	018184



Toe Lift Ankle Joint Head

- 3/16" x 5/8" channel
- Stainless Steel
- Sold individually



Side	Product No.
Left	127007L000
Right	127007R000

Extension Upright with Ankle Joint for Limited and Free Motion (POPE)

- Sold individually
- Infant bar dimensions include ankle joint

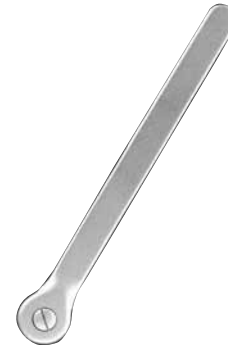

Size	Bar Dimensions	Product No.	
		Limited Motion	Free Motion
Child	3/16" x 5/8" x 9"	023021	023031
Adult	1/4" x 3/4" x 9"	023026	023034

Ankle Joints
and Stirrups

Extension Upright with Double Action Ankle Joint

- Plain and crowned

Size	Bar Dimensions	Product No.	
		Plain	Crowned
Adult	3/16" x 5/8" x 16"	O10263	O10264

Modular Ankle Joint Head: Limited and Free Motion (POPE)

- Designed to be riveted to long or short leg uprights
- Child bar channel: 7/16"
- Adult bar channel: 5/8"
- Sold individually



Size	Product No.	
	Limited Motion	Free Motion
Child	020001	020009
Adult	020005	020012

Modular Limited and Free Motion Ankle Joint Head

- 3/16" x 5/8" channel
- Stainless Steel
- Sold as pairs



Description	Product No.
Limited Motion	1270050000
Free Motion	1270060000

Select Ankle Joint Kit

- Includes the medial and lateral side for 1 leg
- 1 kit per leg is needed

Description	Measurements	Product No.
Pediatric, Aluminum	1 ⁷ / ₈ " x 1" x 1/4"	A224000001
Adult, Aluminum	2 ³ / ₈ " x 1 ¹ / ₈ " x 1/4"	A224000000
Adult, Stainless Steel	2 ³ / ₈ " x 1 ¹ / ₈ " x 1/4"	A224000002



Modular Stainless Steel Double Action Ankle Joint Head

- 3/16" x 5/8" channel
- Sold as a pair

Product No. **1270080000**



Modular Double Action Ankle Joint Head (POPE)

- Short adult and adult bar channel: 9/16"
- Infant bar channel: 1/2"
- Sold individually

Description	Infant	Product No.	
		Short Adult	Adult
Stainless Steel	020020	020027	020035
Stainless Steel*	020033	020029	—
Aluminum	—	020024	020032
Aluminum*	—	020026	—

*with positioning screws

Modular Double Action Ankle Joint with Aluminum Bar (Pope)

- Sold individually
- 3/16" x 5/8" channel

Size	Material	Product No.
Short Adult	Aluminum head	020016
Short Adult*	Aluminum head	020028
Short Adult	Stainless Steel head	020017
Adult	Aluminum head	020018
Adult	Stainless Steel head	020019

*with positioning screws

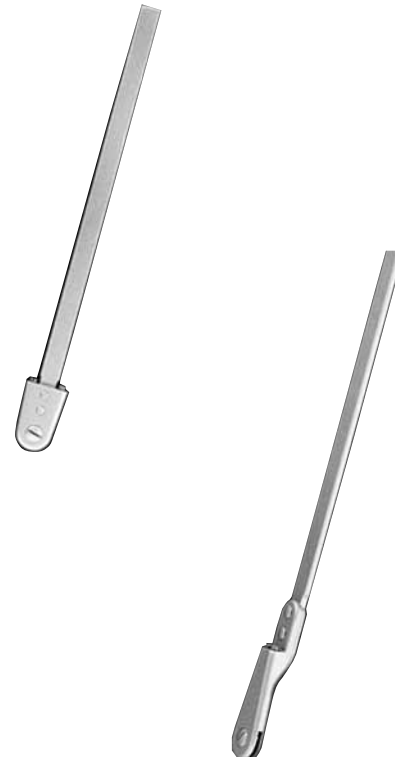

Offset Upright with Double Ankle Joint (POPE)

- Aluminum
- 3/16" x 11/16" x 14 1/4"
- Sold individually

Product No. **018193**

Standard Short Tongue Solid Stirrups

- Height to medial malleolus
- Sole thickness + Heel width = Stirrup length
- Available in toe lift, limited or free motion, and double action

Size	6"	7"	8"	8 ³ / ₄ "	9 ¹ / ₂ "	10 ¹ / ₄ "	11"
Toe Lift							
Infant	035009	035011	035014	—	—	—	—
Child	035010	035012	035015	035018	035021	—	—
Adult	—	—	035016	035019	035022	035024	035023
Limited and Free Motion							
Infant	035027	035030	035033	—	—	—	—
Child	035029	035031	035034	—	035040	—	—
Adult	—	035032	035035	035037	035041	035043	035044
Double Action							
Infant	035057	035058	035060	—	—	—	—
Adult	—	035059	035061	035063	035066	035068	035069



Toe Lift

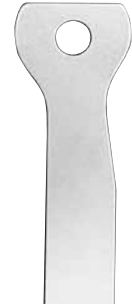

Limited/Free Motion



Double Action

Ankle Joints
and Stirrups

Wide Tongue Stirrup (POPE)

- Eliminates the need for drilling the footwear shank by providing rivet locations which straddle the shank size
- Adult size only

Description	8 ³ / ₄ "	9 ¹ / ₂ "	10 ¹ / ₄ "
Toe Lift	036004	036006	036008
Limited & Free Motion	036010	036012	036014
Double Action	036015	036016	036017



Long Tongue Stirrup (POPE)

- Eliminates the need for drilling the footwear shank by providing rivet locations which straddle the shank size
- Adult size only

Description	9 ¹ / ₂ "	10 ¹ / ₄ "	11"
Toe Lift	037017	037018	—
Limited & Free Motion	037029	037030	—
Double Action	037042	037043	037044

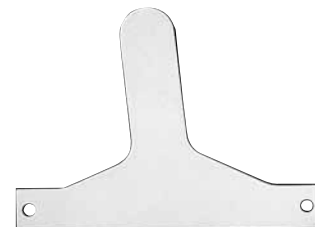

Stainless Steel Split Stirrups (POPE)

- 1/8" x 7/8"
- Sold individually
- Stirrup length = height to medium malleolus plus sole thickness plus 3 mm for caliper plate plus 25 mm for tongue

Description	Product No.
Toe Lift	038029
Limited & Free Motion	038041
Double Action	038054



Flat Caliper Plates

Size	Left	Right
1/8" x 7/8"	038022	038023



Parts for Ankle Joints

Description	Infant	Child	Adult
Joint Spring	20164-001	020038	018213
Adjusting Screw	20162-001	19509-001	19509-001
Joint Screw	19419-001	19400-001	19400-001
Upright	—	020044	020046
Ankle Joint Bushing (nut)	20245-001	O22043	O22043
Ball	20227-001	19508-001	19508-001
Positioning Screw	—	020039	018005
Ankle Joint Oval Nut	—	O22043	O22043



Aluminum Bands, Adult

Description	Dimensions	Product No.
Thigh Band	0.081 x 1 1/2" x 12"	051011
Calf Band	0.081 x 1 1/2" x 9"	022019

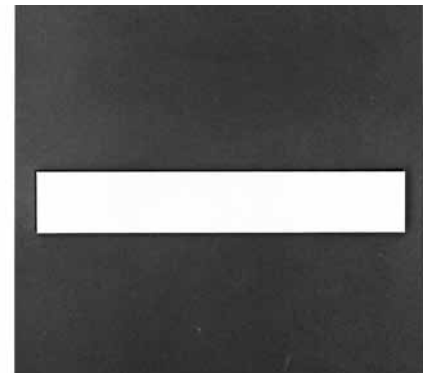

Single Upright (Caliper) Brace Fixed Stop Kit (POPE)

- Fixed Stop Brace indicated for night use in correcting inversion or eversion of the foot, club foot, and to prevent plantar flexion
- Stainless Steel upright and aluminum calf band
- Removable upright
- Fixed stop, steel foot plate with a combination stop and retainer
- Kit includes stainless steel upright, aluminum calf band and stainless steel caliper foot plate

Description	Product No.	
	Left Small	Right Small
Kit	019015	019017
Foot plate	034041	034043
Upright	019014	019014



Ankle Joints
and Stirrups

Single Upright (Caliper) Brace Adjustable Stop Kit (POPE)

- Indicated for treatment of cerebral palsy and to stretch heel cords
- Stainless Steel upright and aluminum calf band
- Serrations on the adjustable stop allow both plantar and dorsiflexion adjustment
- Kit includes stainless steel upright, aluminum calf band and steel caliper foot plate

Size	Dimensions	Upright	Product No.	
			Foot plate	Kit
Left				
Small	1/8" x 1/2" x 10"	019001	034003	019010
Medium	1/8" x 1/2" x 16"	019004	034011	—
Large	3/36" x 1/2" x 17 1/2"	019007	034019	019028
Right				
Small	1/8" x 1/2" x 10"	019001	034006	019012
Medium	1/8" x 1/2" x 16"	019004	034014	019030
Large	3/36" x 1/2" x 17 1/2"	019007	034022	019034



Ankle Joint Spring Toe Lift Child

Product No. **20186-001**

Joint Rivet Adult

- 1/2" x 3/4"

Product No. **20715-001**

Becker Orthopedic - Knee Joint System

Numbering System Explanation

- Most Becker knee joints are available in four sizes: A (Adult), B (Youth), C (Child), and I (Infant)
- In Becker's system, as the sizes get smaller, the dimensions of the stainless steel midsections are proportionally reduced
- Many knee joints are now available with pre-contoured lower joint units for improved cosmesis
- **Step 1:** The first four numbers refer to the model number of the knee joint you wish to use, e.g., 1002.
- **Step 2:** This number is followed by a letter designating joint size, e.g., 1002-A.
- **Step 3:** The letter will be followed by a code number indicating upright thickness (see table), e.g., 1002-A4
Note: Not all joints available in all sizes or materials.
- **Step 4:** This will be followed by a code letter designating upright material and thickness (see table), e.g., 1002-A4T

Upright Material	Code Letter	Upright Thickness	Code No.
Round Edge Aluminum	None	5/32"	2
Square Edge Aluminum	T	1/4"	4
Stainless Steel	S	3/16"	6
Titanium	TI	1/8"	8

- **Step 5:** If the joint is available with contoured lower joint units, a final code letter will be added to indicate the combination you desire, e.g., 1002-A4TR.
- Code Letter "R"
Right Medial Contoured and Right Lateral Straight or Left Lateral Contoured and Left Medial Straight
- Code Letter "L"
Left Medial Contoured and Left Lateral Straight or Right Lateral Contoured and Right Medial Straight
- Code Letter "B"
Both Medial and Lateral Contoured

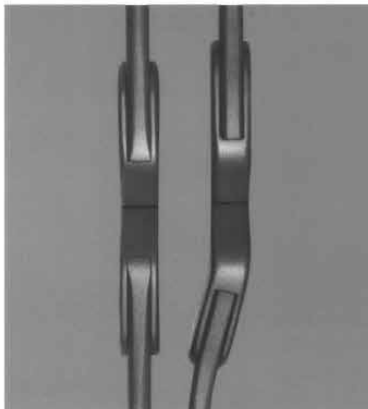

Right Medial Contoured
Right Lateral Straight.
Code Letter "R".

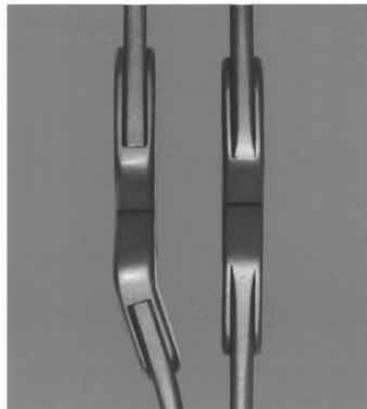

Left Medial Contoured
Left Lateral Straight.
Code Letter "L".

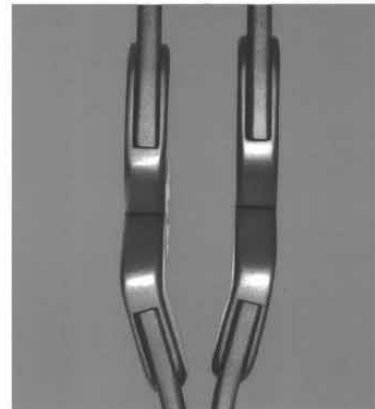

Both Medial and Lateral Contoured
Code Letter "B".

Model 1001 – Ring Lock Knee Joint

- Recommended for large patients and patients with knee flexion contractures, both of which increase the forces on the locking mechanism; ischial weight bearing and perthes orthoses
- NOTE: Do not remove medial or lateral rings



Size	Upright Dimensions	Aluminum Uprights		SS Uprights	Titanium Uprights
		Round Edge	Square Edge	Round Edge	Round Edge
Child	3/16" x 1/2"	1001-C6	1001-C6T	1001-C6S	—
Child	1/8" x 1/2"	1001-C8	1001-C8T	1001-C8S	—
Youth	1/4" x 5/8"	1001-B4	1001-B4T	—	—
Youth	3/16" x 5/8"	1001-B6	1001-B6T	1001-B6S	—
Youth	5/32" x 5/8"	—	—	1001-B2S	—
Adult	5/32" x 3/4"	—	—	1001-A2S	—
Adult	1/4" x 3/4"	1001-A4	1001-A4T	—	—
Adult	3/16" x 3/4"	1001-A6	1001-A6T	1001-A6S	1001-A6TI

Knee Joints

Model 1002 – Modified Ring Lock Knee Joint

- Eliminates the sharp protrusion of standard ring locks in the flexed position
- Infant size joints have no lower joint units: the distal upright is machined to fit into the upper joint unit
- Available with contoured lower joints upon request
- Note: Do not remove medial or lateral rings



Size	Upright Dimensions	Aluminum Uprights		SS Uprights	Titanium Uprights
		Round Edge	Square Edge	Round Edge	Round Edge
Infant	1/8" x 1/2"	1002-I8	1002-I8T	1002-I8S	—
Infant	1/8" x 1/2"	—	—	1002-IIS	—
Child	3/16" x 1/2"	1002-C6	1002-C6T	1002-C6S	—
Child	1/8" x 1/2"	1002-C8	1002-C8T	1002-C8S	—
Youth	5/32" x 5/8"	—	—	1002-B2S	—
Youth	3/16" x 5/8"	1002-B6	1002-B6T	1002-B6S	—
Youth	1/4" x 5/8"	1002-B4	1002-B4T	—	—
Adult	1/4" x 3/4"	1002-A4	1002-A4T	—	—
Adult	3/16" x 3/4"	1002-A6	1002-A6T	1002-A6S	1002-A6TI

To order with contoured lower joints:
Add "B" for medial and lateral contours.
Add "R" for right medial contours.
Add "L" for left medial contours.

Model 1002-A#4HD – Heavy Duty Rings

- Recommended for very large and/or active patients
- Can be used on any 1002-A size joint

Product No. **1002-A#4HD**



Model 1003 – Automatic Spring Lever Knee Joint

- Spring loaded lever system which automatically engages the locking device when the patient fully extends leg
- Since the lock may be disengaged with one hand and engages automatically, it is highly recommended for patients with impaired hand function
- Available with contoured lower joints upon request (specify left, right or both for contoured joints)



Size	Upright Dimensions	Aluminum Uprights		SS Uprights	Titanium Uprights
		Round Edge	Square Edge	Round Edge	Round Edge
Youth	1/4" x 5/8"	1003-B4	1003-B4T	—	—
Youth	3/16" x 5/8"	1003-B6	1003-B6T	1003-B6S	—
Adult	1/4" x 3/4"	1003-A4	1003-A4T	—	—
Adult	3/16" x 3/4"	1003-A6	1003-A6T	1003-A6S	1003-A6TI

Heavy Duty Lever Release Kit for 1003/1004/1007/1014/1015

- Replaces standard bail rod
- Simultaneously locks both joints with a single trigger

Description	Left Lateral/ Left Lever	Right Lateral/ Right Lever
Heavy Duty Lever Release Kit	MX-003-HD/L	MX-003-HD/R

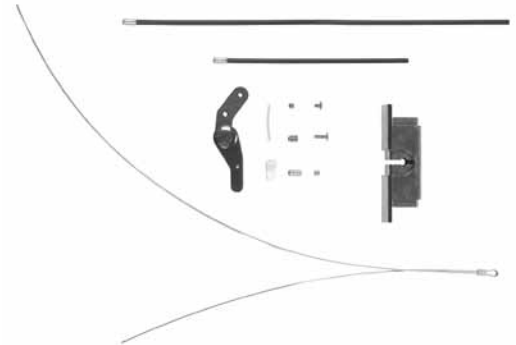

Model 1004 – Posterior Offset Lever Lock Knee Joint

- Designed with the axis of motion located posteriorly to the upright bars
- Ideally suited for patients with impaired hand function
- Optional Urethane Assist Strap can be used to automatically engage lever locks (For "A" Joints, use MX-002-101; For "B" Joints, use MX-005-101)
- Available with contoured lower joints upon request (specify left, right or both for contoured joints)

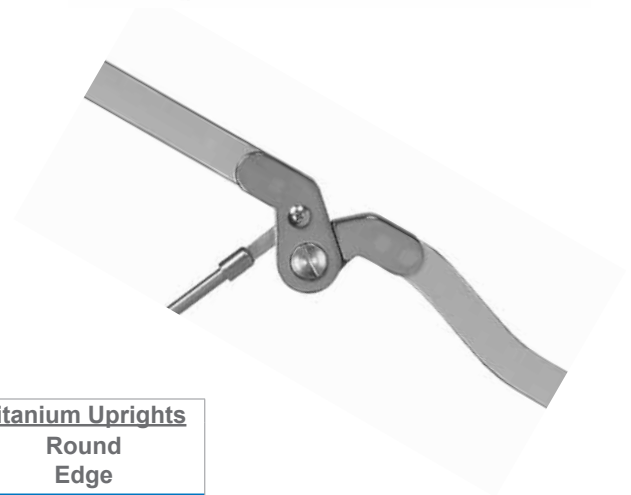

Size	Upright Dimensions	Aluminum Uprights		SS Uprights	Titanium Uprights
		Round Edge	Square Edge	Round Edge	Round Edge
Youth	1/4" x 5/8"	1004-B4	1004-B4T	—	—
Youth	3/16" x 5/8"	1004-B6	1004-B6T	1004-B6S	—
Adult	1/4" x 3/4"	1004-A4	1004-A4T	—	—
Adult	3/16" x 3/4"	1004-A6	1004-A6T	1004-A6S	1004-A6TI

To order with contoured lower joints:
 Add "B" for medial and lateral contours.
 Add "R" for right medial contours.
 Add "L" for left medial contours.

Model 1005 – Free Motion Knee Joint

- Free motion knee joint has a 180° extension stop
- Precision machined midsections move smoothly through the entire range-of-motion

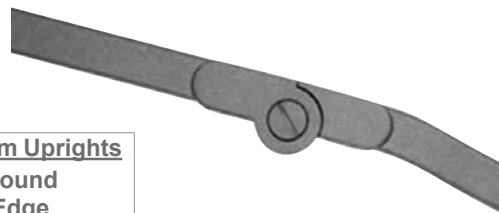

Size	Upright Dimensions	Aluminum Uprights		SS Uprights	Titanium Uprights
		Round Edge	Square Edge	Round Edge	Round Edge
Child	3/16" x 1/2"	1005-C6	1005-C6T	1005-C6S	—
Child	1/8" x 1/2"	1005-C8	1005-C8T	1005-C8S	—
Youth	3/16" x 5/8"	1005-B6	1005-B6T	1005-B6S	—
Youth	5/32" x 5/8"	—	—	1005-B2S	—
Adult	5/32" x 3/4"	—	—	1005-A2S	—
Adult	1/4" x 3/4"	1005-A4	1005-A4T	—	—
Adult	3/16" x 3/4"	1005-A6	1005-A6T	1005-A6S	1005-A6TI

Model 1006 – Adjustable Extension Ring Lock Knee Joint

- Increase or decrease the extension angle by 6° intervals
- Recommended for patients with knee flexion contractures
- Do not remove medial or lateral rings
- C-Size is manufactured differently, showing midsection
- Round edge uprights



Size	Upright Dimensions	Aluminum Uprights	Stainless Steel Uprights
Child	3/16" x 1/2"	1006-C6	1006-C6S
Child	1/8" x 1/2"	1006-C8	1006-C8S
Youth	1/4" x 5/8"	1006-B4	—
Youth	3/16" x 5/8"	1006-B6	1006-B6S
Youth	5/32" x 5/8"	—	1006-B2S
Adult	5/32" x 3/4"	—	1006-A2S
Adult	1/4" x 3/4"	1006-A4	—
Adult	3/16" x 3/4"	1006-A6	1006-A6S

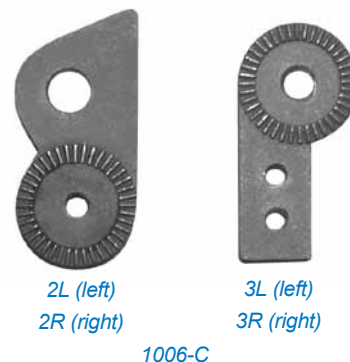

Model 1007 – Adjustable Extension Automatic Spring Lever Knee Joint

- Increase or decrease the extension stop with the serrated disc
- Unique feature of Model 1007 is the spring loaded lever lock to lock the joint at full extension
- Effective for patients with limited hand function
- Round edge uprights

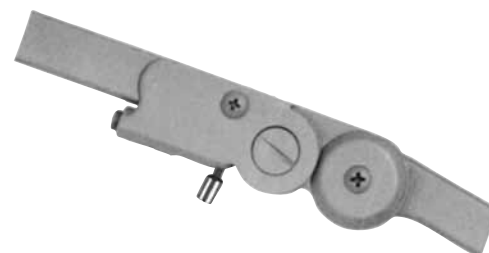

Size	Upright Dimensions	Aluminum Uprights	Stainless Steel Uprights
Youth	1/4" x 5/8"	1007-B4	—
Youth	3/16" x 5/8"	1007-B6	1007-B6S
Adult	1/4" x 3/4"	1007-A4	—
Adult	3/16" x 3/4"	1007-A6	1007-A6S

Model 1008 – Posterior Offset Free Motion Knee Joint

- Developed to create a knee joint with the axis of motion located posteriorly to the upright bars
- Fully interchangeable with the posterior offset ring lock (Model 1012), therefore easily converted to a ring lock by ordering the Model 1012 rings
- Infant size joints have no lower joint unit: the distal upright is machined to fit into the upper joint unit
- Available with contoured lower joints upon request (A & B sizes only)

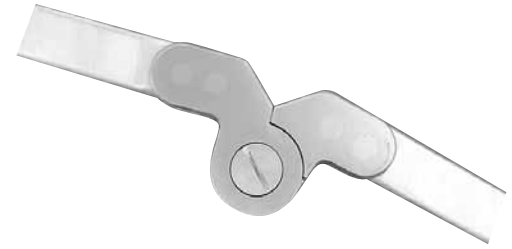

Size	Upright Dimensions	Titanium Uprights		Aluminum Uprights		SS Uprights
		Round Edge	Round Edge	Square Edge	Round Edge	
Infant	1/8" x 1/2"	—	1008-I8	1008-I8T	1008-I8S	
Child	3/16" x 1/2"	—	1008-C6	1008-C6T	1008-C6S	
Child	1/8" x 1/2"	—	1008-C8	1008-C8T	1008-C8S	
Youth	1/4" x 5/8"	—	1008-B4	1008-B4T	—	
Youth	3/16" x 5/8"	—	1008-B6	1008-B6T	1008-B6S	
Adult	1/4" x 3/4"	—	1008-A4	1008-A4T	—	
Adult	3/16" x 3/4"	1008-A6TI	1008-A6	1008-A6T	1008-A6S	

To order with contoured lower joints:
Add "B" for medial and lateral contours.
Add "R" for right medial contours.
Add "L" for left medial contours.

Model 1009 – Polycentric Free Motion Knee Joint

- Approximates the knee's anatomical movement more closely
- Stainless steel midsections for increased durability and strength



Size	Upright Dimensions	Titanium Uprights		Aluminum Uprights		SS Uprights
		Round Edge	Round Edge	Square Edge	Round Edge	
Child	3/16" x 1/2"	—	1009-C6	1009-C6T	1009-C6S	
Child	1/8" x 1/2"	—	1009-C8	1009-C8T	1009-C8S	
Youth	3/16" x 5/8"	—	1009-B6	1009-B6T	1009-B6S	
Adult	1/4" x 3/4"	—	1009-A4	1009-A4T	—	
Adult	3/16" x 3/4"	1009-A6TI	1009-A6	1009-A6T	1009-A6S	

Model 1010 – Adjustable Extension/Flexion Ring Knee Joint

- Provides the orthotist with an extension stop in 6° intervals as well as providing an adjustable flexion stop in 19° intervals (A or B Joints) or 23.75° intervals (C)
- Do not remove medial or lateral ring
- Do not use this joint unilaterally



Size	Upright Dimensions	Aluminum Uprights Round Edge	SS Uprights Round Edge
Child	3/16" x 1/2"	1010-C6	1010-C6S
Child	1/8" x 1/2"	1010-C8	1010-C8S
Youth	1/4" x 5/8"	1010-B4	—
Youth	3/16" x 5/8"	1010-B6	1010-B6S
Adult	1/4" x 3/4"	1010-A4	—
Adult	3/16" x 3/4"	1010-A6	1010-A6S

Model 1011 – Automatic Trigger Lock Knee Joint

- Essentially the same joint as the Model 1003 Automatic Spring Lever Lock; however, the lever is replaced with a locking tip which is attached by cable to a trigger
- Trigger allows patient to disengage locks without bending over
- Locks will automatically engage when leg is extended

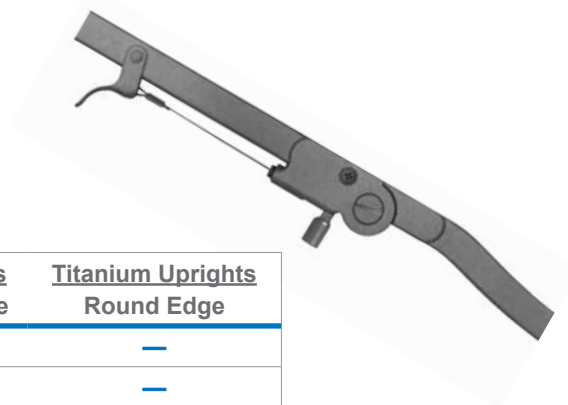

Size	Upright Dimensions	Aluminum Uprights		SS Uprights	Titanium Uprights
		Round Edge	Square Edge	Round Edge	Round Edge
Youth	1/4" x 5/8"	1011-B4	1011-B4T	—	—
Youth	3/16" x 5/8"	1011-B6	1011-B6T	1011-B6S	—
Adult	1/4" x 3/4"	1011-A4	1011-A4T	—	—
Adult	3/16" x 3/4"	1011-A6	1011-A6T	1011-A6S	1011-A6TI

Model 1012 – Posterior Offset Ring Lock Knee Joint

- Axis motion is offset posteriorly from the upright bars, thereby closely approximating the movement of the anatomical knee
- Joint can be easily changed to free motion by removing the rings
- Infant size joints have no lower joint unit: the distal upright is machined to fit into the upper joint unit
- Available with contoured lower joints upon request

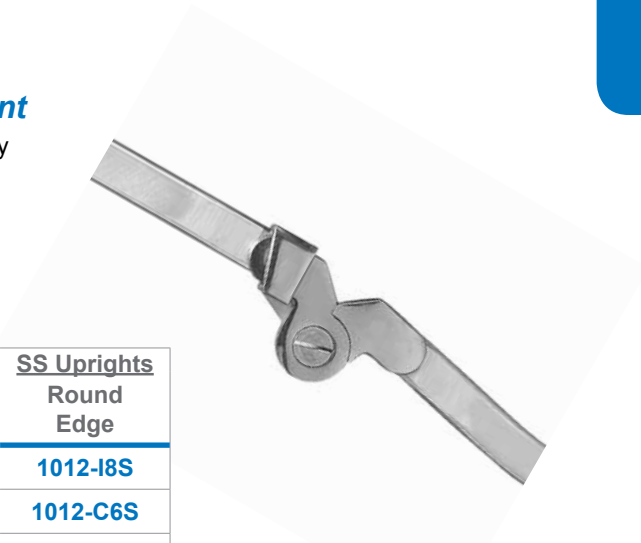

Size	Upright Dimensions	Titanium Uprights	Aluminum Uprights		SS Uprights
		Round Edge	Round Edge	Square Edge	Round Edge
Infant	1/8" x 1/2"	—	1012-I8	1012-I8T	1012-I8S
Child	3/16" x 1/2"	—	1012-C6	1012-C6T	1012-C6S
Child	1/8" x 1/2"	—	1012-C8	1012-C8T	1012-C8S
Youth	1/4" x 5/8"	—	1012-B4	1012-B4T	—
Youth	3/16" x 5/8"	—	1012-B6	1012-B6T	1012-B6S
Adult	1/4" x 3/4"	—	1012-A4	1012-A4T	—
Adult	3/16" x 3/4"	1012-A6TI	1012-A6	1012-A6T	1012-A6S

To order with contoured lower joints:
Add "B" for medial and lateral contours.
Add "R" for right medial contours.
Add "L" for left medial contours.

Model 1013 – Posterior Offset Adjustable Knee Joint

- A-P alignment and extension/flexion angle can be changed by simply removing two screws
- Includes optional bail lock that can be engaged at full extension
- Locking levers can be removed and replaced with included plugs, allowing the joint to function as a free motion posterior offset joint



Uprights	Size	Upright Dimensions	Product No.
Aluminum	Adult	3/16" x 3/4"	1013-A6
Stainless Steel	Adult	3/16" x 3/4"	1013-A6S
Titanium	Adult	3/16" x 3/4"	1013-A6TI

Model 1014 – Ratchet Lock™ Knee Joint

- Designed to promote full knee extension by providing knee stability through incremental range of knee flexion
- Distinctive, anterior low-profile locking mechanism
- Joint features a secure, semi-automatic locking mechanism that can be quickly and easily disengaged
- Weight limits: Adult up to 160 lbs, Youth up to 120 lbs, Child up to 60 lbs

Uprights	Size	Upright Dimensions	Product No.
Aluminum	Adult	3/16" x 3/4"	1014-A6
Aluminum	Youth	3/16" x 5/8"	1014-B6
Aluminum	Child	3/16" x 1/2"	1014-C6
Stainless Steel	Adult	3/16" x 3/4"	1014-A6S
Stainless Steel	Youth	3/16" x 5/8"	1014-B6S
Stainless Steel	Child	3/16" x 1/2"	1014-C6S
Titanium	Adult	3/16" x 3/4"	1014-A6TI



Model 1016 – Tricknee

- Developed for individuals with moderate quadricep weakness
- Differs from traditional drop lock systems by means of a dynamic pattern of spring action
- Spring arrangement provides force to resist flexion during weight bearing and assist extension during swing phase
- Not available with ball catches

Uprights	Size	Product No.
Round Aluminum	1/4" x 5/8"	1016-B4
Square Aluminum	1/4" x 5/8"	1016-B4T
Round Aluminum	3/16" x 5/8"	1016-B6
Square Aluminum	3/16" x 5/8"	1016-B6T
Stainless Steel	3/16" x 5/8"	1016-B6S

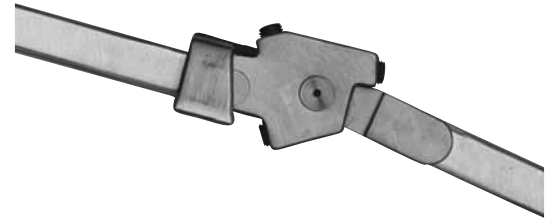

To order with contoured lower joints:
 Add "B" for medial and lateral contours.
 Add "R" for right medial contours.
 Add "L" for left medial contours.

Model 1017-A38

- Designed for patients up to 320 lbs or those with severe biomechanical deficits
- Equipped with 3/8" x 3/4" aluminum uprights
- May be used in either a unilateral or double upright configuration
- Can be fabricated into a variety of orthotic designs including conventional metal and leather, thermoplastics and composites

Product No. **1017-A38**



Model 1018 – Modular Ratchet Lock Knee Joint

- Designed to promote full knee extension by providing knee stability through an incremental range of knee flexion
- Long locking lever is easily operated by the patient
- Lever can also be shortened or configured into a standard bail
- Fully interchangeable with 1017, 9005 and 9006 knee models

Uprights	Size	Upright Dimensions	Product No.
Aluminum	Adult	3/16" x 3/4"	1018-A6
Stainless Steel	Adult	3/16" x 3/4"	1018-A6S
Titanium	Adult	3/16" x 3/4"	1018-A6TI

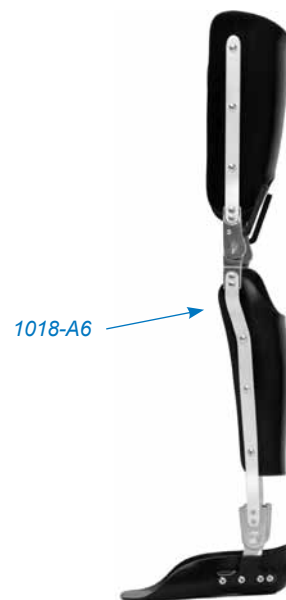

Model S2001 – Assembled and Disassembled Ring Lock Knee Joint

- Stainless steel side plates are riveted on the proximal upright to form the upper joint unit
- Distal bar is machined to fit into the upper joint unit
- NOTE: Do not remove medial or lateral ring
- Model S2001 is assembled with bushing and screw; flexion set at 180°
- Model R2001 is disassembled with rivet and requires distal bar to be shaped



Size	Upright Dimensions	Aluminum Round Edge w/Bushing & Screw	Aluminum Round Edge w/Joint Rivet	Stainless Steel w/Bushing & Screw	Stainless Steel w/Joint Rivet
Child	3/16" x 1/2"	S2001-C6	R2001-C6	S2001-C6S	R2001-C6S
Child	1/8" x 1/2"	S2001-C8	R2001-C8	S2001-C8S	R2001-C8S
Youth	1/4" x 5/8"	S2001-B4	R2001-B4	—	—
Youth	3/16" x 5/8"	S2001-B6	R2001-B6	S2001-B6S	R2001-B6S
Adult	1/4" x 3/4"	S2001-A4	R2001-A4	—	—
Adult	3/16" x 3/4"	S2001-A6	R2001-A6	S2001-A6S	R2001-A6S

Model S2005 – Assembled and Disassembled Free Motion Knee Joints

- Model S2005 is assembled with bushing and screw; flexion set at 180°
- Model R2005 is disassembled with rivet and requires distal bar to be shaped



Size	Upright Dimensions	Aluminum Round Edge w/Bushing & Screw	Aluminum Round Edge w/Joint Rivet	Stainless Steel w/Bushing & Screw	Stainless Steel w/Joint Rivet
Child	3/16" x 1/2"	S2005-C6	R2005-C6	S2005-C6S	R2005-C6S
Child	1/8" x 1/2"	S2005-C8	R2005-C8	S2005-C8S	R2005-C8S
Youth	1/4" x 5/8"	S2005-B4	R2005-B4	—	—
Youth	3/16" x 5/8"	S2005-B6	R2005-B6	S2005-B6S	R2005-B6S
Adult	1/4" x 3/4"	S2005-A4	R2005-A4	—	—
Adult	3/16" x 3/4"	S2005-A6	R2005-A6	S2005-A6S	R2005-A6S

Model 2009 – Automatic Ring Lock Knee Joint

- Model 2009 is a non-protrusion knee joint that combines the simplicity and security of a standard drop lock with automatic locking
- When the joints reach full extension the rings are automatically engaged by springs that are internally housed within the midsections, this feature gives the user the convenience of automatic locking

Size	Upright Dimensions	Product No.	
		Aluminum	Stainless Steel
Youth	$3/16'' \times 5/8''$	2009-B6	2009-B6S
Adult	$3/16'' \times 3/4''$	2009-A6	2009-A6S

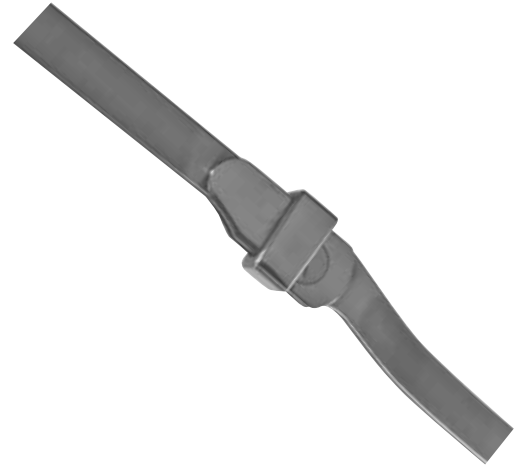

Load Response Knee Joint

- Provides shock absorption during stance phase knee flexion
- Allows 18° of knee flexion during the stance phase of gait
- Pre-loaded spiral torsional spring that maintains knee joint stability for quadricep weakness

Uprights	Size	Upright Dimensions	Product No.	
			Left	Right
Aluminum	Adult	$3/16'' \times 3/4''$	LR-9002-A6-L	LR-9002-A6-R
Stainless Steel	Adult	$3/16'' \times 3/4''$	LR-9002-A6S-L	LR-9002-A6S-R
Titanium	Adult	$3/16'' \times 3/4''$	LR-9002-A6TI-L	LR-9002-A6TI-R

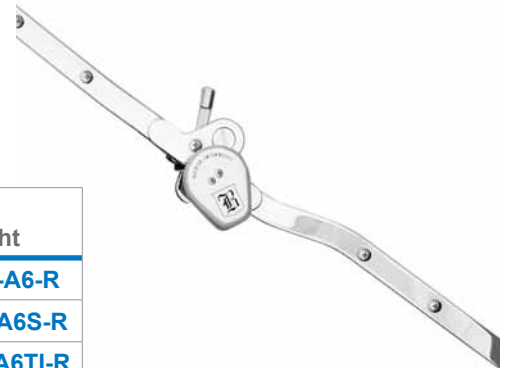

FullStride™ Knee Joint

- Automatic, mechanical locking and unlocking
- Flexible, adaptive, modular design allows joint to be configured as an automatic spring lever lock knee joint if patient needs change
- Durable, straightforward design

Uprights	Size	Upright Dimensions	Product No.
Aluminum	Youth	$3/16'' \times 5/8''$	9006-B6
Stainless Steel	Youth	$3/16'' \times 5/8''$	9006-B6S
Aluminum	Adult	$3/16'' \times 3/4''$	9006-A6
Stainless Steel	Adult	$3/16'' \times 3/4''$	9006-A6S
Titanium	Adult	$3/16'' \times 3/4''$	9006-A6TI

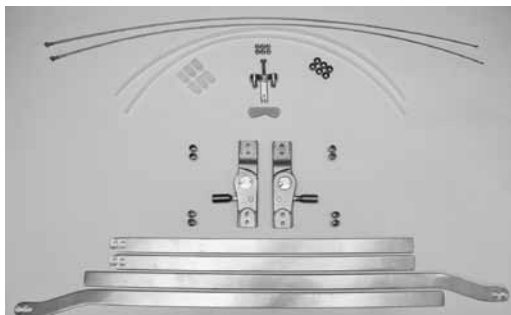

FullStride™ Kit with GX-Assist

- For individuals with significant weakness of hip musculature
- Available with GX-Assist option that incorporates a pneumatic spring on the lateral joint unit to assist in knee extension during the swing phase of gait
- Available in a 125N pneumatic spring (for standard application) or 175N (for high activity patients); also 75N
- To specify spring when ordering, replace ? with 75, 125 or 175

Uprights	Size	Upright Dimensions	Product No.	
			Left	Right
Aluminum	Youth	3/16" x 5/8"	9006-GX-B6-L-?	9006-GX-B6-R-?
Stainless Steel	Youth	3/16" x 5/8"	9006-GX-B6S-L-?	9006-GX-B6S-R-?
Aluminum	Adult	3/16" x 3/4"	9006-GX-A6-L-?	9006-GX-A6-R-?
Stainless Steel	Adult	3/16" x 3/4"	9006-GX-A6S-L-?	9006-GX-A6S-R-?
Titanium	Adult	3/16" x 3/4"	9006-GX-A6TI-L-?	9006-GX-A6TI-R-?



Knee Joints

Replacement Cable for FullStride/SafetyStride

- Stainless steel

Product No.	9006-A6#12
-------------	------------

Model 9005 – SafetyStride

- Ability to resist knee flexion at any angle
- Designed to unlock at terminal stance, an interval lever re-engages during swing phase to ensure knee joint stability prior to heel contact
- Available with GX-Assist option that incorporates a pneumatic spring on the lateral joint unit to assist in knee extension during the swing phase of gait
- Available in a 125N pneumatic spring (for standard application) or 175N (for high activity patients); also 75N
- To specify spring when ordering, replace ? with 75, 125 or 175

Uprights	Upright Dimensions	Product No.	
		Left	Right
SafetyStride			
Aluminum	3/16" x 3/4"	9005-A6-L	9005-A6-R
Stainless Steel	3/16" x 3/4"	9005-A6S-L	9005-A6S-R
Titanium	3/16" x 3/4"	9005-A6TI-L	9005-A6TI-R
With GX-Assist			
Aluminum	3/16" x 3/4"	9005-GX-A6-L-?	9005-GX-A6-R-?
Stainless Steel	3/16" x 3/4"	9005-GX-A6S-L-?	9005-GX-A6S-R-?
Titanium	3/16" x 3/4"	9005-GX-A6TI-L-?	9005-GX-A6TI-R-?



Model 9015 – GXL Knee Joint

- A free motion knee that is designed to provide extension assist, while not preventing knee flexion
- Has option of locking at full extension for use as a locked knee joint
- Switching between free motion with extension assist to locked is performed simply by rotating the Key Locks
- Available in a 125N pneumatic spring (for standard application) or 175N (for high activity patients); also 75N
- To specify spring when ordering, replace ? with 75, 125 or 175



Uprights	Upright Dimensions	Product No.	
		Left	Right
Aluminum	3/16" x 3/4"	9015-A6-L-?	9015-A6-R-?
Stainless Steel	3/16" x 3/4"	9015-A6S-L-?	9015-A6S-R-?
Titanium	3/16" x 3/4"	9015-A6TI-L-?	9015-A6TI-R-?

Knee Joint Add-On Codes	
Description	Code
With Ball Catches Installed (PR)	H-BC-P
With Ball Catches Installed (EA)	H-BC-HALF
With Heavy Duty Rings (EA)	K-1
Mixed Knee Joints (EA)	K-2
Flexion Set in Bars (EA)	K-3
Polished Uprights (EA)	K-5
Sand Blasted Joints (EA)	K-6
Knee Joint Flexion Stops (EA)	K-7
Straight Distal Uprights (EA)	K-8
Attachment of D-8 Spring Pull (EA)	K-9

Replacement Parts for Knee Joints						
Knee Joint Screw	Z993300 Screw 3A	Z093400 Bushing 3B	Z993301 Screw 3A	Z093401 Bushing 3B	Z993302 Screw 3A	Z093402 Bushing 3B
1001	A, B4	A, B4	B6, B2	B6, B2	C	C
1002	A, B4	A, B4	B6, B2	B6, B2	C I8, II	C I8, II
1003	A&B	A&B				
1004	A&B	A&B				
1005	A	A	B	B	C	C
1006	A, B4	A, B4	B6, B2	B6, B2	C	C
1007	A&B	A&B				
1008	A&B	A&B			C	C
1009	A	A	B	B	C	C
1010	A, B4	A, B4	B6	B6	C	C
1011	A&B	A&B				
1012	A&B	A&B			C	C
1023	A&B	A&B				
Please reference "Z" numbers when ordering						

Replacement Parts for Knee Joints - Continued									
Knee Joint Screw	Z190215 LVR TIP 5	Z993251 Screw 5A	Z993400 Bushing 5B	Z995102 Spring 5C	Z190235 LVR TIP 5	Z993250 Screw 5A	ZPP3401 Bushing 5B	Z995103 Spring 5C	Z993200 Set 5D
1001									
1002									
1003	A	A	A	A	B	B	B	B	A&B
1004	A	A	A		B	B	B		
1005									
1006									
1007	A	A	A	A	B	B	B	B	A&B
1008									
1009									
1010									
1011	(Z190218)	A	A	A	(Z190238)	B	B	B	Z995267
1012									
1023		A	A	A		B	B	B	A&B
Please reference "Z" numbers when ordering									

Knee Joints

Fillauer - King Pin™ Lock Knee Joint

- Secure, automatic locking at full extension
- Release lever allows for finger pull or bail rod
- Stainless steel construction
- Accepts 3/16" or 1/4" uprights



Description	Product No.
King Pin™ Knee Joint Kit with Lever Release & Bail	
Both Straight L/XL	025400
Left Medial Contoured L/XL	025410
Right Medial Contoured L/XL	025420
Both Contoured L/XL	025430
Note: also available in S/M lock kits	
King Pin™ Upright Kit	
1/4" x 3/4" Aluminum	025240
3/16" x 3/4" Aluminum	025242
3/16" x 3/4" Stainless Steel	025244
Fabrication Dummy Kit with 4 reusable plates	025300

Spring Loaded Lever Lift

- Complete assembly
- Stainless steel, polished

Description	Product No.
Spring Loaded Lever Kit	029033
Rod Only	029009
Spring Only	029017
Guide Post Only	029025



Trigger Release for Camlocks

- Proximal release for sitting
- Easy use from standing position
- Especially good for RGOs
- For medium and large CamLock Joint

Description	Product No.
Trigger Release with Dual Cable	023750
Trigger Release with Bail Rod	023751
Trigger Release with Single Cable	023753



Zippy Quick Release

- Allows easy removal and reattachment from AFO upper assemblies
- May have other applications

Description	Product No.
Zippy Quick Release w/Cleat	020700
Zippy Quick Release with Threaded Mounting Holes in Cleat	020710



Cam Lock Knee Joint Assemblies with Screws

- Secure and long wearing
- Stainless steel joint with aluminum or stainless steel bars
- Cable release kit (023463)
- Sold as a pair

Description	Stainless Steel	Aluminum
Small Joint Head - 1/8" (3 mm) x 1/2" (13 mm) Bar		
Straight	023620SS	023620SA
Left Medial Contoured	023620SSL	023620SAL
Right Medial Contoured	023620SSR	023620SAR
Both Contoured	023620SSB	023620SAB
Medium Joint Head - 3/16" (5 mm) x 5/8" (16 mm) Bar		
Straight	023660MS	023660MA
Left Medial Contoured	023660MSL	023660MAL
Right Medial Contoured	023660MSR	023660MAR
Both Contoured	023660MSB	023660MAB
Large Joint Head - 3/16" (5 mm) x 3/4" (19 mm) Bar		
Straight	023660LS	023660LA
Left Medial Contoured	023660LSL	023660LAL
Right Medial Contoured	023660LSR	023660LAR
Both Contoured	023660LSB	023660LAB

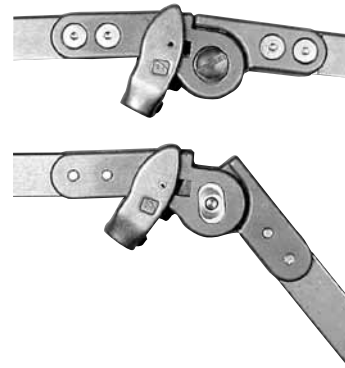
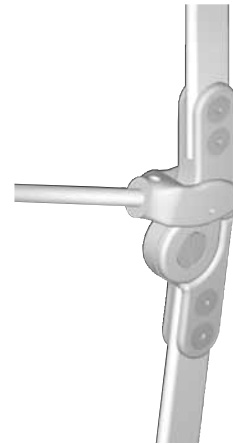

Knee Joints

Swing Phase Lock Kit

- Restore swing phase
- More cosmetic gait
- Easy to fabricate in-house or central fabrication
- Use any ankle or as KO

Side	Product No.
Left	IQ200L
Right	IQ200R



Swing Phase Lock Remote Auxiliary Mounting Bracket

- Aluminum

Product No. **029850**



Contoured Knee Joint with Drop Lock

- Side bars are press-fit and secured in corresponding channels with supplied screws
- Not intended for use as an articulating joint
- Use in pairs; specify both medial and lateral part numbers
- Note: General use is contoured/medial and straight/lateral

Channel Size	Left Leg		Right Leg	
	Lateral	Medial	Medial	Lateral
5/8" Upper and Lower	71305	71304	71305	71304
3/4" Upper and 5/8" Lower	71310	71311	71310	71311
3/4" Upper and Lower	71301	71300	71301	71300



OTS - InterLock Orthotic Knee Joint

- Functions as drop lock, bail lock, or lever release
- Built in spring loaded "bail stop"; no drilling or setting ball retainers required

Size	Style	Product No.
Small		
3/16" x 1/2"	Straight	IL512KS
3/16" x 1/2"	Left Medial Contoured	IL512KL
3/16" x 1/2"	Right Medial Contoured	IL512KR
Medium		
3/16" x 5/8"	Straight	IL516KS
3/16" x 5/8"	Left Medial Contoured	IL516KL
3/16" x 5/8"	Right Medial Contoured	IL516KR
1/4" x 5/8"	Straight	IL616KS
1/4" x 5/8"	Left Medial Contoured	IL616KL
1/4" x 5/8"	Right Medial Contoured	IL616KR
Large		
3/16" x 3/4"	Straight	IL519KS
3/16" x 3/4"	Left Medial Contoured	IL519KL
3/16" x 3/4"	Right Medial Contoured	IL519KR
1/4" x 3/4"	Straight	IL619KS
1/4" x 3/4"	Left Medial Contoured	IL619KL
1/4" x 3/4"	Right Medial Contoured	IL619KR



Lever Release Kits	
Description	Product No.
for 512 only	LRK512 SM
for 516 through 619	LRK1619 LG

StepLock Orthotic Knee Joint

- The StepLock is entirely CNC machined to high tolerances
- CNC Machining, coupled with our bright nickel finish, produces a smooth feel and high-tech appearance
- It is modular and interchangeable with the Interlock
- Its unique “ratchet action” makes it ideal as a standing assist or for flexion contractures



Knee Joints

Size	Style	Product No.
Small		
3/16" x 1/2"	Straight	SL512KS
3/16" x 1/2"	Left Medial Contoured	SL512KL
3/16" x 1/2"	Right Medial Contoured	SL512KR
3/16" x 1/2"	Double Contoured	SL512KB
Medium		
3/16" x 5/8"	Straight	SL516KS
3/16" x 5/8"	Left Medial Contoured	SL516KL
3/16" x 5/8"	Right Medial Contoured	SL516KR
3/16" x 5/8"	Double Contoured	SL516KB
1/4" x 5/8"	Straight	SL616KS
1/4" x 5/8"	Left Medial Contoured	SL616KL
1/4" x 5/8"	Right Medial Contoured	SL616KR
1/4" x 5/8"	Double Contoured	SL616KB
Large		
3/16" x 3/4"	Straight	SL519KS
3/16" x 3/4"	Left Medial Contoured	SL519KL
3/16" x 3/4"	Right Medial Contoured	SL519KR
3/16" x 3/4"	Double Contoured	SL519KB
1/4" x 3/4"	Straight	SL619KS
1/4" x 3/4"	Left Medial Contoured	SL619KL
1/4" x 3/4"	Right Medial Contoured	SL619KR
1/4" x 3/4"	Double Contoured	SL619KB
Hip Joints		
3/16" x 1/2"		SL512H
3/16" x 5/8"		SL516H
1/4" x 5/8"		SL616H
3/16" x 3/4"		SL519H
1/4" x 3/4"		SL619H

Lever Release Kits	
Description	Product No.
for 512 only	LRK512 SM
for 516 through 619	LRK1619 LG

Bail Kits

- For use on Original Series InterLock and StepLock

Description	Product No.
Soldered Stainless Steel Bail	SBK
Rod-Style Bail	RBK

Trulife - Drop Lock Non-Protrusion Joint

- Stainless Steel
- Sold as pairs or as single sides
- Upper section: 17"; Lower section: 22"

Description		1/8" x 1/2"	3/16" x 5/8"	3/16" x 3/4"
Pair		O229000051	O229000032	O229000033
Right Side Only		O11941	O11949	O11950
Left Side Only		O10941	O10949	O10950
Part No.	Parts			
1	17" Left Upper Section	—	10433	20886-001
1	17" Right Upper Section	—	10434	10436
2	22" Lower Section	10464	10446	10447
3	Joint Screw	O21033	O21035	20726-001
4	Bearing Nut	O22038	O22040	O22041
5	Nylatron Washer	22889-001	22890-001	22891-001
6	Drop Lock	23501-001	O28012	O28014



Aluminum Long Leg Drop Lock

- N.P.J. (Non-Protrusion Joint)
- Stainless Steel heads
- Upper section: 17"; Lower section: 22"
- Sold as pairs

Description		1/8" x 1/2"	3/16" x 5/8"	3/16" x 3/4"	1/4" x 5/8"	1/4" x 3/4"
Pair		O229000011	O229000012	O229000013	O229000022	O229000023
Right Side Only		O11942	O11943	O11944	O11946	O11947
Left Side Only		O10942	O10943	O10944	O10946	O10947
Part No.	Parts					
1	17" Left Upper Section	10154	O10433	O10367	O10371	O10373
1	17" Right Upper Section	11154	O10366	O10368	O10372	O10374
2	22" Lower Section	O10418	O10419	O10420	O10422	O10423
3	Joint Screw	O21033	O21035	20726-001	O21036	20726-001
4	Bearing Nut	O22038	O22040	O22041	O22041	O22041
5	Nylatron Washer	22889-001	23021	22891-001	22890-001	22891-001
6	Drop Lock	23501-001	O28012	O28014	23505-001	23506-001



Plain Aluminum Long Leg Drop Lock

- Sold as pairs

Description		1/4" x 1/2"	1/4" x 5/8"	1/4" x 3/4"
Pair		O002120510	O002120520	O002120530
Right Side Only		—	O11117	O11119
Left Side Only		—	O10117	O10119
Part No.	Parts			
1	17" Left Upper Section	22027-001	—	22032-001
1	17" Right Upper Section	22026-001	—	22031-001
2	22 1/2" Lower Section	—	2120505010	2120506010
3	Joint Screw	2011908504	—	2011908503
4	Bearing Nut	—	2021906010	2021906010
5	Nylatron Washer	21929-001	19604-001	—
7	Drop Lock	21960-001	19608-001	



Knee Joints

Offset Drop Lock Knee Joint

- Aluminum
- Upper Section: 16"; Lower section: 20 1/2"
- Sold as pairs

Description		1/4" x 5/8"
Pair		O006120000
Right Side Only		O11613
Left Side Only		O10613
Part No.	Parts	
1	16" Upper Bar	22027-001
1	Right Upper Head	227011R000
2	Left Upper Head	227011L000
3	20 1/2" Lower Bar	2210401700
4	Lower Head	2270120000
5	Joint Screw	19591-001
6	Bearing Nut	2021907010
7	Nylatron Washer	19604-001
8	Drop Lock	21957-001



Lerman Long Leg Drop Lock Knee Joint

- Aluminum
- Upper section: 17"; Lower section: 22"
- Sold as pairs

Size	Product No.
3/16" x 5/8"	O246000011
1/4" x 5/8"	O246000021



French Lock Knee Joint

- Stainless Steel
- Upper section: 17"; Lower section: 22¹/₂"
- Sold as pairs

Description		3/16" x 1/2"	3/16" x 3/4"
Pair		O002310020	O002310040
Part No.	Parts		
1	17" Right Upper Section	—	—
1	17" Left Upper Section	—	—
2	22 ¹ / ₂ " Lower Section	22142-002	2120709030
3	Joint Screw	19591-001	19591-001
4	Bearing Nut	2021907010	2021907010
5	Nylatron Washer	—	19604-001
6	Bail Screw	2011908604	2011908604
7	Drop Lock	22543-003	22543-003



Spring Release Lever Kit

- Automatically pushes drop lock down to lock brace when patient stands erect
- Finger loop permits ease of access for unlocking

Description	1/8"	3/16"
Kit	049001	049004
Replacement Parts		
Rod	20583-001	—
Spring	20582-001	—
Stud	—	20585-001

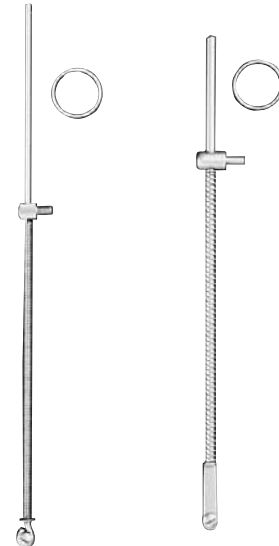

Polycentric Lerman Knee Joint

- Adjustable ROM
- Upper section: 17"; Lower section: 22¹/₂"
- Sold as pairs

Size	Product No.
3/16" x 3/4"	O22516
1/4" x 3/4"	O225000006



Becker Orthopedic - Model 1020 – Ring Lock Hip Joint

- Recommended for large or extremely active patients
- All mid-sections and uprights are stainless steel
- Available with a straight proximal upright instead of a “T” bar; when ordering, add an “S” to the beginning of the product number
- Note: Do not remove rings

Model 1022 – Modified Ring Lock Hip Joint

- No protrusions to catch or fray garments when the patient is in the seated position
- All mid-sections and uprights are stainless steel
- Available with a straight proximal upright instead of a “T” bar; when ordering, add an “S” to the beginning of the product number
- Note: Do not remove rings

Size	Upright Dimension	Side	Product No.	
			Standard	Modified
Child	3/16" x 1/2"	Left	1020-CL	1022-CL
Child	3/16" x 1/2"	Right	1020-CR	1022-CR
Child	3/16" x 1/2"	Pair	1020-CP	1022-CP
Youth	3/16" x 5/8"	Left	1020-BL	1022-BL
Youth	3/16" x 5/8"	Right	1020-BR	1022-BR
Youth	3/16" x 5/8"	Pair	1020-BP	1022-BP
Adult	3/16" x 3/4"	Left	1020-AL	1022-AL
Adult	3/16" x 3/4"	Right	1020-AR	1022-AR
Adult	3/16" x 3/4"	Pair	1020-AP	1022-AP



1020

1022

Hip Joints

Model 1023 – Trigger Lock Hip Joint

- Incorporates a lever mechanism which automatically engages the lock when the patient stands
- Trigger disengages the lock
- All mid-sections and uprights are stainless steel
- Available with a straight proximal upright instead of a “T” bar; when ordering, add an “S” to the beginning of the product number

Model 1025 – Free Motion Hip Joint with 180° Extension Stop

- All mid-sections and uprights are stainless steel
- Straight proximal upright is ideal for attaching a spinal orthosis
- Available with a straight proximal upright instead of a “T” bar; when ordering, add an “S” to the beginning of the product number

Size	Upright Dimension	Side	Product No.	
			Trigger Lock	Free Motion
Child	3/16" x 1/2"	Left	—	1025-CL
Child	3/16" x 1/2"	Right	—	1025-CR
Child	3/16" x 1/2"	Pair	—	1025-CP
Youth	3/16" x 5/8"	Left	1023-BL	1025-BL
Youth	3/16" x 5/8"	Right	1023-BR	1025-BR
Youth	3/16" x 5/8"	Pair	1023-BP	1025-BP
Adult	3/16" x 3/4"	Left	1023-AL	1025-AL
Adult	3/16" x 3/4"	Right	1023-AR	1025-AR
Adult	3/16" x 3/4"	Pair	1023-AP	1025-AP

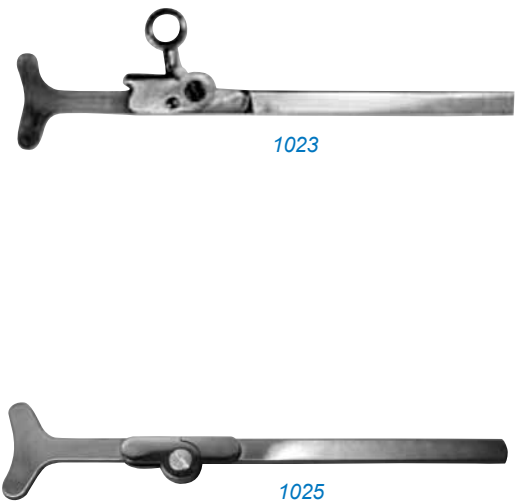

1023

1025

Model 1030 – Abduction Flexion Hip Joint

- Strong and versatile hip joint, manufactured of stainless steel
- Provides control in two planes
- Abduction adjustable in 9° increments

Side	Upright Dimensions	Product No.
Left	3/16" x 5/8"	1030-BL
Right	3/16" x 5/8"	1030-BR
Pair	3/16" x 5/8"	1030-BP

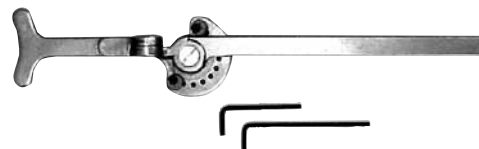

Model 1040 – Millennium Hip Joint

- Can be utilized to manage the right or left side
- Features motion control from 0° to 120° of flexion/extension
- Abduction/adduction adjustments in 9° increments
- Slotted uprights for height adjustment

Product No. **1040-B**



Polycentric Total Hip Replacement (THR) Joint

- 1/4" x 5/8"
- Aluminum
- Upper and lower bar is 7"

Side	Product No.
Left	O10065
Right	O10066

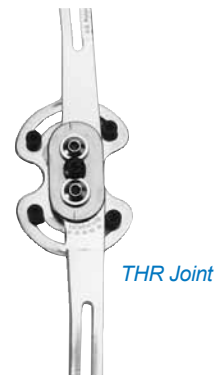

Multi-Axis Orthotic (MAO) Hip Joint

- 1/4" x 3/4"
- Aluminum
- Upper bar 8 3/4"; Lower bar 7 1/4"
- Slotted bars

Product No. **O237000000**



Lerman Drop Lock Hip Joint

- 3/16" x 3/4", stainless steel
- 1/4" x 3/4", aluminum
- Upper bar 8 1/2"; Lower bar 11 3/4"

Side	Product No.	
	Stainless Steel	Aluminum
Left	O27700	O27710
Right	O27701	O27711



Model 2020 – Ring Lock Hip Joint

- Standard ring lock hip joint
- Manufactured with aluminum or stainless steel proximal and distal uprights
- Joint side plates are stainless steel



Model 2020

Model 2025 – Free Motion Hip Joint

- Free motion hip joint with a 180° extension stop
- Manufactured with aluminum or stainless steel proximal and distal uprights
- Joint side plates are stainless steel



Model 2025

Model 2032 – Two Position Ring Lock Hip Joint

- Designed to lock at 180° and at 90°
- Suggested for patients who need additional support to sit upright
- Manufactured with aluminum or stainless steel proximal and distal uprights
- Joint side plates are stainless steel



Model 2032

Size	Upright Dimension	Side	Aluminum Ring Lock	Aluminum Free Motion	Aluminum Two Position
Child	3/16" x 1/2"	Left	2020-C6L	2025-C6L	2032-C6L
Child	3/16" x 1/2"	Right	2020-C6R	2025-C6R	2032-C6R
Child	3/16" x 1/2"	Pair	2020-C6P	2025-C6P	2032-C6P
Child	1/8" x 1/2"	Left	2020-C8L	2025-C8L	—
Child	1/8" x 1/2"	Right	2020-C8R	2025-C8R	—
Child	1/8" x 1/2"	Pair	2020-C8P	2025-C8P	—
Youth	1/4" x 5/8"	Left	2020-B4L	2025-B4L	2032-B4L
Youth	1/4" x 5/8"	Right	2020-B4R	2025-B4R	2032-B4R
Youth	1/4" x 5/8"	Pair	2020-B4P	2025-B4P	2032-B4P
Adult	1/4" x 3/4"	Left	2020-A4L	2025-A4L	2032-A4L
Adult	1/4" x 3/4"	Right	2020-A4R	2025-A4R	2032-A4R
Adult	1/4" x 3/4"	Pair	2020-A4P	2025-A4P	2032-A4P

Size	Upright Dimension	Side	Stainless Steel Ring Lock	Stainless Steel Free Motion	Stainless Steel Two Position
Child	3/16" x 1/2"	Left	2020-C6SL	2025-C6SL	2032-C6SL
Child	3/16" x 1/2"	Right	2020-C6SR	2025-C6SR	2032-C6SR
Child	3/16" x 1/2"	Pair	2020-C6SP	2025-C6SP	2032-C6SP
Child	1/8" x 1/2"	Left	2020-C8SL	2025-C8SL	—
Child	1/8" x 1/2"	Right	2020-C8SR	2025-C8SR	—
Child	1/8" x 1/2"	Pair	2020-C8SP	2025-C8SP	—
Youth	3/16" x 5/8"	Left	2020-B6SL	2025-B6SL	2032-B6SL
Youth	3/16" x 5/8"	Right	2020-B6SR	2025-B6SR	2032-B6SR
Youth	3/16" x 5/8"	Pair	2020-B6SP	2025-B6SP	2032-B6SP
Adult	3/16" x 3/4"	Left	2020-A6SL	2025-A6SL	2032-A6SL
Adult	3/16" x 3/4"	Right	2020-A6SR	2025-A6SR	2032-A6SR
Adult	3/16" x 3/4"	Pair	2020-A6SP	2025-A6SP	2032-A6SP

**Becker Orthopedic
Model L-400 – Bilateral Hip-Ankle Torsion Splint**

- Flexible rotator cables are attached at the hip and the ankle
- Includes: pelvic band, hip joints, stirrups, cables, and webbing straps

ORDERING INFORMATION:

1. Choose the product number that matches the cable diameter you desire
 2. Specify the pelvic circumference
 3. Specify the A-C length (top of pelvic band to floor)
- Note: A deduction will be made from the A-C length to get the actual cable length

Cable Diameter	Product No.
1/4"	L-400B
5/16"	L-400A
3/8"	L-400X

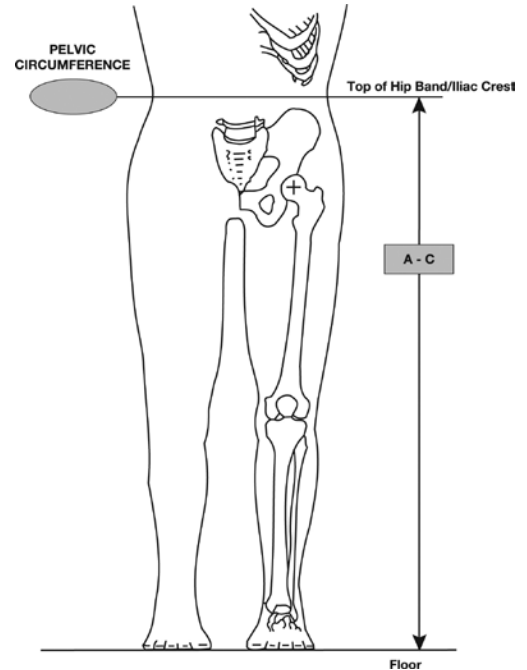

Torsion Splints

Model H-400 – Bilateral Hip-Knee Torsion Shafts (attached to AFO's)

- Flexible rotator cables are attached to the hip and the knee
- Includes: pelvic band, hip joints, AFO attachments, and cables

ORDERING INFORMATION:

1. Choose the product number that matches the cable diameter you desire
 2. Specify the pelvic circumference
 3. Specify the A-B length (top of pelvic band to knee center)
 4. Specify the B-D length (knee center to bottom edge of calf band)
- Note: A deduction will be made from the A-B length to get the actual cable length

Cable Diameter	Product No.
1/4"	H-400B
5/16"	H-400A
3/8"	H-400X

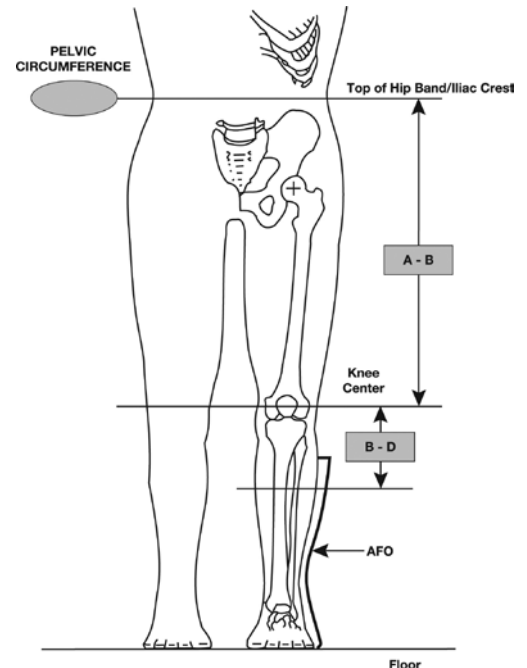

Model K-400 – Bilateral Hip KAFO Torsion Splint

- Flexible rotator cables are attached to the hip and the lateral up-right of the K.A.F.O.
- Includes: Pelvic band, hip joints, thigh attachments, and cables
- ORDERING INFORMATION:
 1. Choose the product number that matches the cable diameter you desire
 2. Specify the pelvic circumference
 3. Specify the A-E length (top of pelvic band to mid-thigh)
- Note: A deduction will be made from the A-E length to get the actual cable length

Cable Diameter	Product No.
1/4"	K-400B
5/16"	K-400A
3/8"	K-400X

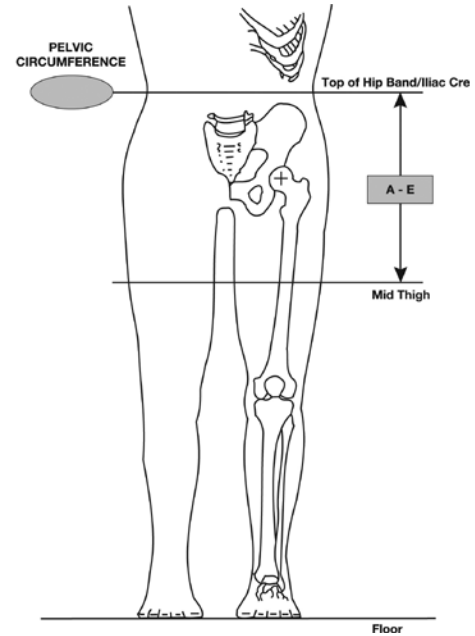

Torsion Splints

Model R-400 – Bilateral Hip-Knee-Ankle Torsion Splint

- Flexible rotator cables are attached to the knee joint and stirrup
- Includes: pelvic band, rigid thigh uprights and knee joints, stirrups, cables, and webbing straps
- ORDERING INFORMATION:
 1. Choose the product number that matches the cable diameter you desire
 2. Specify the pelvic circumference
 3. Specify the A-B length (top of pelvic band to knee center)
 4. Specify the B-C length (knee center to floor)
- Note: A deduction will be made from the B-C length to get the actual cable length

Cable Diameter	Product No.
1/4"	R-400B
5/16"	R-400A
3/8"	R-400X

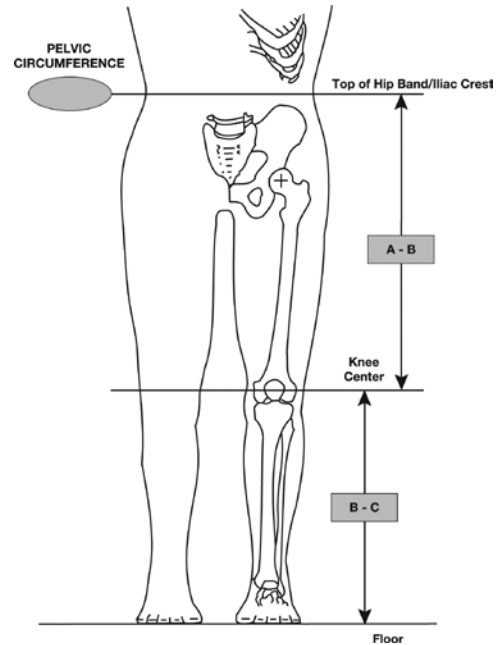

Model 400-1 – Flexible Torsion Cable

- Specify length from the end of one connector to the other, internal or external rotation, and right or left leg
- Sold individually

Cable Diameter	Product No.
1/4"	400-1B
5/16"	400-1A
3/8"	400-1X



Model 400-1

Model 400-2 – Hip Joint

- Sold individually

Cable Diameter	Product No.
1/4"	400-2B
5/16"	400-2A
3/8"	400-2X



Model 400-2

Model 400-4 – Stirrup

- Left, right, or pair

Cable Diameter		Product No.		
		Left	Right	Pair
1/4"		400-4BL	400-4BR	400-4BP
5/16"		400-4AL	400-4AR	400-4AP
3/8"		400-4XL	400-4XR	400-4XP



Model 400-4

Model 400-6 – Thigh Attachment

- Sold individually, left or right

Cable Diameter	Product No.
1/4"	400-6B
5/16"	400-6A
3/8"	400-6X



Model 400-6

Model 400-7 – AFO Attachment

- Sold individually

Cable Diameter	Product No.	
	Left	Right
1/4"	400-7BL	400-7BR
5/16"	400-7AL	400-7AR
3/8"	400-7XL	400-7XR



Model 400-7

Becker Orthopedic - Knee Pads

- 5-buckle, 4-buckle and 3-buckle pads
- Replace ? with P (pediatric), S (small), M (medium) or L (large)
- Replace ?? with color from color chart below

Description	Product No.
5-Buckle Knee Pad	D-9-?-??
4-Buckle Knee Pad	D-10-?-??
3-Buckle Knee Pad	D-11-?-??

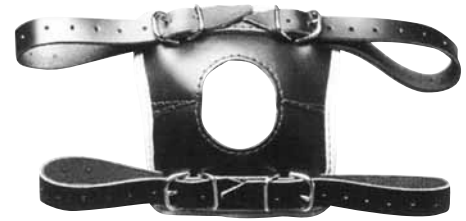

Ordering Example
 Model **D-9**
 Size **S**
 Color **BEIGE**
D-9-S-BEIGE

Condyle Pads

- Round condyle pad for Free Motion or Lever Lock joints

Size	Product No.
Infant	D-14-I
Child	D-14-C
Youth	D-14-Y
Adult	D-14-A



T-Strap

- Padded and non-padded
- Replace ? with S (small), M (medium) or L (large)
- Replace ?? with color from color chart below

Description	Left Lateral Right Medial	Right Lateral Left Medial
T-Strap	D-21-LL/RM-?-??	D-21-RL/LM-?-??
Padded T-Strap	D-21P-LL/RM-?-??	D-21P-RL/LM-?-??



Color Chart	
Color	Code
Beige	BEIGE
Brown	BRWN
Smoked Elk	S.ELK
Black	BLK
White	WHITE

Ordering Example
 Model **D-21-LL/RM**
 Size **S**
 Color **BEIGE**
D-21-LL/RM-S-BEIGE

Leather Parts

Model 400-8 – Pelvic Band

- May be used with A, B and X sizes of hip joints
- Available circumference sizes: 15-30
- Replace ? with pelvic circumference

Product No. **400-8-?**

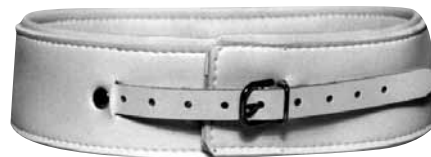

Model 400-9 – Pelvic Band with Hip Joints Attached

- Specify pelvic circumference
- Diameter ⁵/₁₆" and ³/₈" available in circumference sizes: 15-30
- Replace ? with pelvic circumference

Cable Diameter	Product No.
¹ / ₄ "	400-9B
⁵ / ₁₆ "	400-9A-?
³ / ₈ "	400-9X-?



Trulife - T-Straps Standard Design

- Made of 6-7 oz. leather
- Lined with cowhide

Color	Dimensions	Left Lateral Right Medial	Right Lateral Left Medial
Black	1 ¹ / ₂ " x 3 ¹ / ₂ " x 11"	209LLM-00B-L302	209LRM-00B-L302
Brown	1 ¹ / ₂ " x 3 ¹ / ₂ " x 11"	209LLM-00B-R302	209LRM-00B-R302
Smoked Elk	1 ¹ / ₂ " x 3 ¹ / ₂ " x 11"	209LLM-00S-E302	209LRM-00S-E302
Black	1 ³ / ₄ " x 4 ¹ / ₂ " x 15"	209LLL-00B-L303	209LRL-00B-L303
Brown	1 ³ / ₄ " x 4 ¹ / ₂ " x 15"	209LLL-00B-R303	209LRL-00B-R303
Smoked Elk	1 ³ / ₄ " x 4 ¹ / ₂ " x 15"	209LLL-00S-E303	209LRL-00S-E303
Black	2 ¹ / ₂ " x 5" x 16"	209LLX-L0B-L304	209LRX-L0B-L304
Brown	2 ¹ / ₂ " x 5" x 16"	209LLX-L0B-R304	209LRX-L0B-R304
Smoked Elk	2 ¹ / ₂ " x 5" x 16"	209LLX-L0S-E304	209LRX-L0S-E304

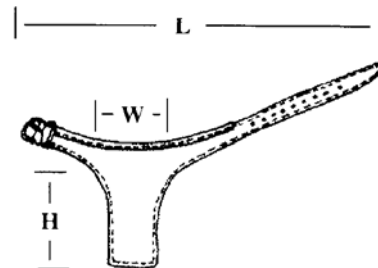

T-Straps Standard with Soft Center

- Made of 6-7 oz. leather
- Padded with volara and lined with cowhide
- Available in Black

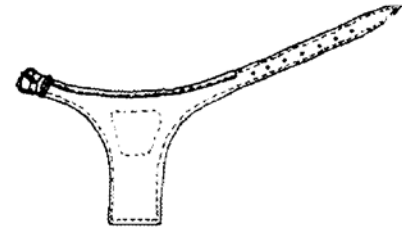

Dimensions	Left Lateral Right Medial	Right Lateral Left Medial
1 ¹ / ₂ " x 3 ¹ / ₂ " x 11"	209LLM-00B-L312	209LRM-00B-L312
1 ³ / ₄ " x 4 ¹ / ₂ " x 15"	209LLL-00B-L313	209LRL-00B-L313
2 ¹ / ₂ " x 5" x 16"	209LLX-L0B-L314	209LRX-L0B-L314

Knee Cap, Soft Center Style

- Top grade leather
- Padded with felt and lined with cowhide



Size	Width	Height	Black	Product No.	
				Brown	Smoked Elk
2X-Small	3"	3 ¹ / ₂ "	209L0X-XSB-L098	209L0X-XSB-R098	209L0X-XSS-E098
X-Small	3 ³ / ₄ "	3"	209L0X-S0B-L099	209L0X-S0B-R099	209L0X-S0S-E099
Small	3 ³ / ₄ "	4 ¹ / ₄ "	209L0S-00B-L100	209L0S-00B-R100	209L0S-00S-E100
Medium	4 ¹ / ₄ "	4 ³ / ₄ "	209L0M-00B-L101	209L0M-00B-R101	209L0M-00S-E101
Large	4 ¹ / ₂ "	5"	209L0L-00B-L102	209L0L-00B-R102	209L0L-00S-E102
X-Large	5"	5 ¹ / ₂ "	209L0X-L0B-L103	209L0X-L0B-R103	209L0X-L0S-E103
2X-Large	5 ¹ / ₄ "	6"	209L0X-XLB-L104	209L0X-XLB-R104	209L0X-XLS-E104

Leather Parts

