

## LOWER EXTREMITY COMPONENTS

### Feet

- Foresee Orthopedic..... 658
- Freedom Innovations..... 659
- Kingsley..... 660
- Ossur Americas..... 660-661
- Trulife..... 661-662
- WillowWood..... 663

### Endoskeletal and Knees

- ESP..... 664-665
- Fillauer Companies..... 665-667
- Grace Prosthetics..... 668
- Ossur Americas..... 668-669
- Otto Bock..... 669
- TiMed..... 670-672
- Trulife..... 672-674
- WillowWood..... 675-676

### Liners

- ALPS..... 677-680
- ESP..... 680-681
- Euro International..... 682-683
- Evolution..... 683
- Medi USA..... 684-685
- Ossur..... 685
- WillowWood..... 686

### Sleeves

- ALPS..... 687-688
- Comfort Products..... 689
- ESP..... 690
- Euro International..... 690
- New Options Sports..... 691
- P.O.R. Inc..... 691
- Silipos..... 692
- SPS..... 693
- Syncor..... 693-694

### Suspension

- Knit-Rite..... 694-695
- Syncor..... 696

### Valves

- ALPS..... 696
- ESP..... 697
- Evolution Industries..... 698
- Fillauer Companies..... 698
- Trulife..... 698

### Locks

- Coyote Designs..... 699-700
- Fillauer Companies..... 701
- KISS Suspension..... 702
- Ossur Americas..... 703
- WillowWood..... 703

### Socks and Sheaths

- Comfort..... 704
- Knit-Rite..... 704-707
- Silipos..... 708
- STS..... 708

### Shrinkers

- Knit-Rite..... 709

## UPPER EXTREMITY COMPONENTS

### Hosmer

- Hooks..... 710-711
- Terminal Device..... 711
- Baby Mitt..... 712
- Hands..... 712-713
- Wrist and Elbows..... 715
- Elbow Hinges and Harnesses..... 716



**Foresee Orthopedic - S.A.F.E. II**

- Stores and releases energy throughout its full length
- When the foot bends, the keel compresses, much like a spring
- As the body moves forward, the keel releases its energy, thrusting the leg forward
- Size Availability:
  - 1/4" heel wide, 14-17 cm
  - 3/8" heel narrow, 18-21 cm
- 12 month warranty



Ordering Example	
Style .....	<b>S2</b>
Type .....	<b>S</b>
Keel .....	<b>O</b>
Heel Height .....	<b>38</b>
Heel Density .....	<b>M</b>
Width .....	<b>N</b>
Size .....	<b>18</b>
Side .....	<b>L</b>
Color .....	<b>1</b>
<b>S2SO38MN18L1</b>	

Ordering Chart for S.A.F.E. II									
Style	Type	Keel	Heel Height	Heel Density	Width	Size cm	Left/Right	Color	
S2=SAFE II	S=Standard	O=Orange	38=3/8"	S=Soft	W=Wide	13-24	L=Left R=Right	1=Caucasian 2=Light Negroid 3=Medium Negroid 4=Dark Negroid 5=Light Latin 6=Medium Latin 7=Dark Latin	
	W=Waterproof (1/4" wide only)	Standard-Moderate Activity	14=1/4"	M=Medium F=Firm	N=Narrow				
	R=Red	Firm-High Activity							
	Y=Yellow	Flexible Low Activity							

\*Some styles not available in all sizes



### Freedom Innovations - Defender

- Smooth rollover with exceptional ground compliance in a foot that is lightweight, robust, and maintenance free
- Increased toe lever length provides the highest degree of energy storage-return available in pediatric foot
- Integrated pediatric pyramid attachment and patented technology eliminates bolt holes in the forefoot; ensuring optimal strength and performance
- User Weight Rating: 100 lbs
- 18 month warranty; 60 day trial period



Description	Model No.
Defender Foot	<b>FS3-P</b>
Foot Shell Sizes 16-18	<b>FTC-1M-1</b>
Foot Shell Sizes 19-21	<b>FTC-2M-1</b>

**Please provide the following when ordering a foot shell:**

- Model number
- Generation: 1 or 2
- Profile: Mid (M)
- Cap: 1
- Size: 16-21
- Skin Tone: Light (L), Medium (M) or Dark (D)
- Side: Left (L) or Right (R)
- Please refer to Foot Shell Ordering Example



Foot Shell Ordering Example	
Model . . . . .	<b>FTC</b>
Generation . . . . .	<b>2</b>
Profile . . . . .	<b>M</b>
Cap . . . . .	<b>1</b>
Size . . . . .	<b>20</b>
Skin Tone . . . . .	<b>L</b>
	<b>4-R</b>
Side . . . . .	<b>R</b>
<b>FTC-2M-120L4-RR</b>	

Build Height and Weight		
Sizes	Height	Weight
16-18 cm	2 <sup>3</sup> / <sub>8</sub> " (61 cm)	6 oz (175 g)
19-21 cm	3" (76 cm)	8 oz (225 g)

Defender Stiffness Category Chart							
Weight (lbs)	20-30	31-40	41-50	51-60	61-70	71-80	81-100
Category	1P	2P	3P	4P	5P	6P	1A



**Kingsley - Pediatric Feet**

Description	Heel Cushions	Heel Height	Sizes	Part No.	
<b>Juvenile SACH Foot</b>	Medium	10-13 cm Flat 14-17 cm 1/4" 18-22 cm 3/8"	10-22 cm	<b>K06</b>	
<b>Juvenile Smooth SACH Foot</b> • Excellent for active children	Medium	14-17 cm 1/4" 18-21 cm 3/8"	14-21 cm	<b>KJ6</b>	
<b>Juvenile Symes</b> • Aluminum plate keel • 1" clearance	Medium	10-13 cm Flat 14-17 cm 1/4" 18-22 cm 3/8"	10-22 cm	<b>K07J</b>	

**Ossur - Flex-Foot® Junior**

- Low Profile energy storing foot with integrated male pyramid
- Pyramid shape contributes to progressive stiffening of the foot
- 3/8" heel height
- Rated to 100 lbs
- Build Height: 1<sup>13</sup>/<sub>16</sub>"
- Weight: 10.2 oz
- 8 month limited warranty



Description	Model No.
Male Pyramid	<b>JRP0</b>
Foot Shell	<b>JRX50</b>

Category Selection Chart		
Weight (kg)	Weight (lbs)	Category
15-24 kg	33-53 lbs	1
25-34 kg	54-75 lbs	2
35-45 kg	76-99 lbs	3

**Flex Foot Ordering Example**

Model .....**JRP0**  
 Category.....**2**  
 Size.....**19**  
 Side.....**R**  
**JRP0219R**

**Foot Cover Example**

Model .....**JRX50**  
 Size.....**19**  
 Side.....**R**  
**JRX5019R**



### Flex-Run™ Junior

- Custom designed solution for children
- Vertical compliance and efficient energy return are must-haves for high active children
- Designed to be the most flexible of running feet
- Increased cushioning, lower frequency dynamic make this foot ideal for transfemoral and transtibial users
- Impact Level: High to Extreme
- Weight rating up to 325 lbs (130 kg)
- Weight of Foot: 11.9 oz (336 g)
- Build height: 8<sup>1</sup>/<sub>4</sub>" (209 mm)
- One size available
- Adapter Options: Male or Female bolt on pyramid



Description	Model No.
Flex-Run Kit	<b>FSX107</b>
<b>Components</b>	
Attachment Plate	<b>FWX40001</b>
Male Pyramid Foot Adapter Set (75 g, M10 x 30 mm)	<b>FWX00030</b>
Female Pyramid Foot Adapter Set (100 g, M10 x 35 mm)	<b>CM150161</b>

Flex-Run Junior Category Selection Guide								
Patient Weight (lbs)	99-115	116-130	131-150	151-170	171-194	195-220	221-256	257-287
High to Extreme Impact Level	2	3	4	5	6	7	8	9

### Trulife - Child's Play Foamer Foot

- Solid foam foot without a keel
- Designed to be incorporated into a prosthesis for patients with partial foot amputations
- Minimum Clearance: 3" (7.6 cm)
- Available in sizes 13-21 cm
  - Solid toe sizes 13-15 cm
  - Split toe sizes: 16-21 cm
- 1 year warranty

Foot Size	Heel Height
13-15	1/4" (6 mm)
16-18	3/8" (9.5 mm)
19-21	1/2" (13 mm)

Description	Model No.
Caucasian	<b>SFF132</b>
Light Brown	<b>SFF142</b>
Dark Brown	<b>SFF144</b>



**Foamer Foot  
Ordering Example**

Model ..... **SFF132**  
 Foot Size ..... **13**  
 Side ..... **L**  
**SFF132-13-L**



**Child's Play Foot**

- Sculpted cosmesis reflect natural appearance of child's foot
- Delrin keel offers shock absorption and a smooth roll over
- Appropriate for all lower limb pediatric amputees, including Symes
- Weight limit 65 kg/144 lbs
- Available in sizes 13-21 cm
- Solid Toe sizes 13-15; Split Toe sizes 16-21
- 24 month warranty on Keel and 12 month warranty on shell

**Keel Selection Instructions:**

1. In the charts below, find the appropriate weight, activity level and limb length factors.
2. Sum these three factors.
3. With the factor sum, find the appropriate keel in the Keel Selection Table and check for availability by foot size.

**Note:** Sizes 13-15 cm do not have split toes cosmesis.

**Warning:** Choosing a lower strength keel than what is suggested based on the above procedure and patient data will void the warranty.



Table I			
Weight	Factor	Weight	Factor
13-14 kg 30-33 lbs	0.8	31-34 kg 70-75 lbs	3.8
15-16 kg 34-37 lbs	1.0	35-37 kg 76-83 lbs	4.0
17-18 kg 38-41 lbs	1.2	38-40 kg 84-89 lbs	4.2
19-20 kg 42-45 lbs	1.8	41-44 kg 90-97 lbs	4.8
21-22 kg 46-49 lbs	2.0	45-48 kg 98-105 lbs	5.0
23-24 kg 50-53 lbs	2.2	49-51 kg 106-113 lbs	5.2
25-26 kg 54-58 lbs	2.8	52-56 kg 114-123 lbs	5.8
27-28 kg 59-63 lbs	3.0	57-60 kg 124-133 lbs	6.0
29-30 kg 64-69 lbs	3.2	61-65 kg 134-144 lbs	6.2

Table II	
Activity Level	Factor
Low	-0.6
Medium-Low	-0.4
Medium	0
Medium-High	0.3
High	0.5

Table III	
Limb Length	Factor
AK/Short BK	-0.4
Medium BK	0
Long BK/Symes	0.3

**Childs Play Foot  
Ordering Example**

Caucasian ..... **SLF132**  
 Light Brown ..... **SLF142**  
 Dark Brown ..... **SLF144**  
 Foot Size ..... **19**  
 Side ..... **R**  
 Keel ..... **D3**  
**SLF132-19-R-D3**

Child's Play Foot Bolt,  
 8 x 60 mm (included)  
**SFB544**

Keel Selection Table		
FactorSum	Keel	Foot Sizes (cm)
0.5 – 1.4	D1	13, 14, 15
1.5 – 2.4	D2	13, 14, 15, 16, 17, 18
2.5 – 3.4	D3	13, 14, 15, 16, 17, 18, 19, 20, 21
3.5 – 4.4	D4	16, 17, 18, 19, 20, 21
4.5 – 5.4	D5	19, 20, 21
5.5 – 6.4	D6	19, 20, 21



### WillowWood - P-POD™ SACH Foot

- Made of composite, which makes it extremely durable
- Weight limit of 132 lbs (60 kg)
- Available in Buff (B), Medium Brown (M), or Tan (T)
- Heel Height: 9-17 cm are 1/4"; 18-22 cm are 3/8"
- Heel Inserts: Soft, medium, and firm heel inserts are included with size 15-22 cm; not used with size 9-14 cm
- 12 month warranty

Model No.

PPS

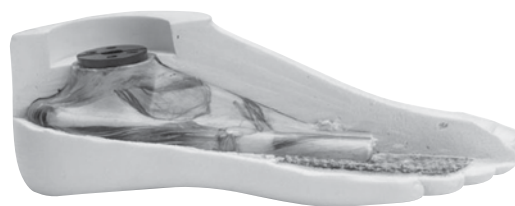

#### SACH Ordering Example

Model .....PPS  
 Size .....10  
 Side .....R  
 Color.....B  
 Toe Stiffness .....2

**PPS-10RB-2**

### P-POD™ Impulse Feet

- Uses Pathfinder™ composite material with a Kevlar® heel; material combination provides durability and energy return
- Weight limit of 132 lbs (60 kg)
- Withstands the wear and tear children put it through
- Available in Buff (B), Medium Brown (M), or Tan (T)
- Heel Height: Sizes 13-17 cm are 1/4", 18-22 cm are 3/8"
- Heel Inserts: Soft, medium, and firm heel inserts are included with size 15-22 cm; not used with size 13-14 cm
- 12 month warranty

Model No.

PPI



Pediatrics

Foot Size	Low Toe (2)	Regular Toe (3)	High Toe (4)
13-14	<20 lbs	20-35 lbs	>35 lbs
15-16	<30 lbs	30-45 lbs	>45 lbs
17-18	<35 lbs	35-50 lbs	>50 lbs
19-20	<45 lbs	45-70 lbs	>70 lbs
21-22	<60 lbs	60-90 lbs	>90 lbs

#### Impulse Ordering Example







Model .....PPI  
 Size .....17  
 Side .....L  
 Color.....M  
 Toe Stiffness .....3

**PPI-17LM-3**





**ESP - Haberman Alignment Devices**

- High grade, lightweight Titanium construction

Description and Part Weights	Product No.	
<b>Central Core</b> <ul style="list-style-type: none"> <li>• Foundation for attachment of all other modules</li> <li>• Build height: .650 in</li> <li>• 97 g</li> </ul>	<b>HAD-CC-P</b>	
<b>Locking Bar Wedge</b> <ul style="list-style-type: none"> <li>• One included with every HAD-CC-P</li> <li>• 10 g</li> </ul>	<b>HAD-W-P</b>	
<b>Sliding 4-Hole Plate (threaded)</b> <ul style="list-style-type: none"> <li>• Build height: .200 in</li> <li>• 63 g</li> </ul>	<b>HAD-4HPT-P</b>	
<b>Sliding 4-Hole Plate (unthreaded)</b> <ul style="list-style-type: none"> <li>• Build height: .200 in</li> <li>• 60 g</li> </ul>	<b>HAD-4HPU-P</b>	
<b>Sliding Pyramid</b> <ul style="list-style-type: none"> <li>• Build height: .400 in</li> <li>• 45 g</li> </ul>	<b>HAD-SP-P</b>	
<b>Sliding Pyramid Receiver</b> <ul style="list-style-type: none"> <li>• Build height: .600 in</li> <li>• 44 g</li> </ul>	<b>HAD-SPR-P</b>	
<b>Rotating Housing Plate</b> <ul style="list-style-type: none"> <li>• Must be used with HAD-RSA-P</li> <li>• Build height: .200 in</li> <li>• 31 g</li> </ul>	<b>HAD-RHP-P</b>	
<b>Sliding Rotating Threaded Adapter</b> <ul style="list-style-type: none"> <li>• Must be used with HAD-TP-P or HAD-TPR-P</li> <li>• Build height: .600 in</li> <li>• 43 g</li> </ul>	<b>HAD-SRTA-P</b>	
<b>Threaded Pyramid</b> <ul style="list-style-type: none"> <li>• Build height: .75 in</li> <li>• 39 g</li> </ul>	<b>HAD-TP-P</b>	
<b>Threaded Pyramid Receiver</b> <ul style="list-style-type: none"> <li>• Build height: 1.062 in</li> <li>• 41 g</li> </ul>	<b>HAD-TPR-P</b>	



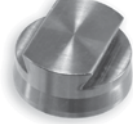



ESP - Haberman Alignment Devices - Continued		
<ul style="list-style-type: none"> <li>High grade, lightweight Titanium construction</li> </ul>		
Description and Part Weights	Product No.	
<b>Rotating Slide Adapter</b> <ul style="list-style-type: none"> <li>Must be used with HAD-RHP</li> <li>Build height: .400 in</li> <li>527 g</li> </ul>	HAD-RSA-P	
<b>Sliding Tube Clamp Adapter</b> <ul style="list-style-type: none"> <li>Build height: .125 in</li> <li>50 g</li> </ul>	HAD-STCA-P	
<b>Threaded Female Dovetail</b> <ul style="list-style-type: none"> <li>Build height: .600 in</li> <li>42 g</li> </ul>	HAD-TFD-P	







Fillauer - MightyMite® Components		
Description	Product No.	
<b>Sach Foot Adapter with Medium Ti Pyramid</b> <ul style="list-style-type: none"> <li>Includes foot bolt</li> <li>Rated to 132 lbs</li> </ul>	FC100110	
<b>1/4" Sach Foot Growth Compensation Spacer</b> <ul style="list-style-type: none"> <li>Includes lock washer</li> <li>Rated to 132 lbs</li> </ul>	FC100104	
<b>1/2" Sach Foot Growth Compensation Spacer</b> <ul style="list-style-type: none"> <li>Includes lock washer</li> <li>Rated to 132 lbs</li> </ul>	FC100102	
<b>4-Hole Connector with Medium Ti Pyramid</b> <ul style="list-style-type: none"> <li>Rated to 132 lbs</li> </ul>	FC100114	
<b>Rotatable Medium Pyramid Receiver</b> <ul style="list-style-type: none"> <li>Rated to 132 lbs</li> <li>Includes screw set</li> </ul>	FC100134	
<b>Rotatable Small Pyramid Receiver</b> <ul style="list-style-type: none"> <li>Rated to 99 lbs</li> <li>Includes screw set</li> </ul>	FC100144	
<b>Rotatable Pyramid</b> <ul style="list-style-type: none"> <li>Rated to 132 lbs</li> </ul>	FC100135	



**Fillauer - MightyMite® Components - Continued**

Description	Product No.	
<p><b>AK Socket Adapter with Rotation</b></p> <ul style="list-style-type: none"> <li>• With lamination dummy</li> <li>• Rated to 132 lbs</li> </ul>	<p><b>FC100130</b></p>	
<p><b>4-Hole Adapter with Rotation</b></p> <ul style="list-style-type: none"> <li>• Rated to 132 lbs</li> <li>• Includes screw set</li> </ul>	<p><b>FC100132</b></p>	
<p><b>4-Hole Distal Attachment Block</b></p> <ul style="list-style-type: none"> <li>• Rated to 132 lbs</li> <li>• Includes screws, vinyl caps and lamination plate</li> </ul>	<p><b>FC100150</b></p>	
<p><b>BK Socket Adapter with Medium Titanium Pyramid</b></p> <ul style="list-style-type: none"> <li>• Includes lamination cap</li> <li>• Rated to 132 lbs</li> </ul>	<p><b>FC100152</b></p>	
<p><b>Alignment Adaptor</b></p>	<p><b>FC100160</b></p>	
<p><b>Tube Clamp - Aluminum</b></p> <ul style="list-style-type: none"> <li>• Rated to 132 lbs</li> </ul> <p><b>Tube Clamp - Titanium</b></p> <ul style="list-style-type: none"> <li>• Rated to 132 lbs</li> </ul>	<p><b>FC100122</b></p> <p><b>FC100123</b></p>	
<p><b>Integrated 22 mm Pylon - Aluminum</b></p> <ul style="list-style-type: none"> <li>• Medium Pyramid Receiver</li> <li>• Rated to 99 lbs</li> </ul>	<p><b>FC100118</b></p>	
<p><b>Integrated 22 mm Pylon - Alloy Steel</b></p> <ul style="list-style-type: none"> <li>• Medium Titanium Pyramid Receiver</li> <li>• Medium Aluminum Pyramid Receiver</li> <li>• Rated to 132 lbs</li> </ul>	<p><b>FC100119</b></p> <p><b>FC100120</b></p>	



Fillauer MightyMite® Components - Continued		
Description	Product No.	
<p><b>Integrated 22 mm Pylon - Alloy Steel</b></p> <ul style="list-style-type: none"> <li>• Adult Pyramid Receiver</li> <li>• Rated to 132 lbs</li> </ul>	FC100121	
<p><b>Pylon Tube - Alloy Steel</b></p> <ul style="list-style-type: none"> <li>• Rated to 132 lbs</li> </ul> <p><b>Pylon Tube - Aluminum</b></p> <ul style="list-style-type: none"> <li>• Rated to 99 lbs</li> </ul>	FC100142 FC100140	
<p><b>4-Bar Knee with pyramid attachment</b></p> <ul style="list-style-type: none"> <li>• Rated to 132 lbs</li> <li>• Standard 22 mm pylon</li> <li>• Adjustable Extension Assist</li> </ul>	FC100510	
<p><b>4-Bar Knee without proximal attachment</b></p> <ul style="list-style-type: none"> <li>• Rated to 132 lbs</li> <li>• Standard 22 mm pylon</li> <li>• Adjustable Extension Assist</li> </ul>	FC100500	
<p><b>MiniMac Knee with pyramid attachment</b></p> <ul style="list-style-type: none"> <li>• Automatic locking mechanism</li> <li>• Rated to 132 lbs</li> <li>• Lightweight (11.1 oz)</li> <li>• Adjustable stance flexion</li> </ul>	FC100520	
<p><b>Proximal Pyramid Adapter</b></p> <ul style="list-style-type: none"> <li>• Rated to 132 lbs</li> </ul>	FC100501	
<p><b>Proximal Threaded Adapter</b></p> <ul style="list-style-type: none"> <li>• Rated to 132 lbs</li> </ul>	FC100504	

Pediatrics



**Grace Prosthetics - Pediatric Grace Plate**

- A 4-hole thermoplastic or laminated socket adaptor that fits almost all pediatric prosthetic components
- Comes complete with necessary screws for attachment

Product No. **1210-P**

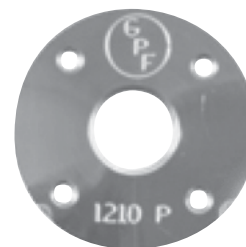





**Ossur - Components**

Description	Weight Limit	Material	Weight	Product No.	
4-Prong Socket Adapter	100 lbs	Stainless Steel	79 g/2.8 oz	<b>AJ-114040</b>	
Female Pyramid Insert	100 lbs	Aluminum	36 g/1.3 oz	<b>AJ-142300</b>	
Male Pyramid Insert	100 lbs	Stainless Steel/ Aluminum	36 g/1.3 oz	<b>AJ-133300</b>	
4-Hole Socket Adapter	100 lbs	Aluminum	46 g/1.6 oz	<b>AJ-122100</b>	
4-Hole Male Pyramid Adapter	100 lbs	Stainless Steel/ Aluminum	39 g/1.4 oz	<b>AJ-233100</b>	
4-Prong Female Pyramid Adapter	100 lbs	Aluminum	34 g/1.2 oz	<b>AJ-242100</b>	
Female Pyramid Tube Clamp	100 lbs	Aluminum	48 g/1.7 oz	<b>AJ-342100</b>	



### Ossur - Components - Continued

Description	Weight Limit	Material	Weight	Product No.	
<b>22 mm Tube</b> <ul style="list-style-type: none"> <li>Length: 250 mm</li> </ul>	100 lbs	Aluminum	104 g/ 3.7 oz	<b>AJ-712010</b>	
<b>Sach Foot Adapter</b>	100 lbs	Stainless Steel/ Aluminum	54 g/ 1.9 oz	<b>AJ-833100</b>	
<b>Total Knee JR</b> <ul style="list-style-type: none"> <li>Polycentric knee with geometric locking system</li> <li>Adjustable stance flexion; Adjustable extension promoter</li> <li>160 degrees of knee flexion available</li> <li>24 month warranty</li> </ul>	100 lbs		395 g/ 0.87 lbs	<b>1100</b>	
<b>Total Knee JR 4-Hole Adapter</b>	100 lbs	Aluminum		<b>AJ-122300</b>	
<b>Total Knee JR Pyramid Adapter</b>	100 lbs	Aluminum/ Titanium		<b>AJ-831300</b>	
<b>Junior Shin Ferrule</b> <ul style="list-style-type: none"> <li>Protects knee unit and increases ease of foam cover application</li> </ul>				<b>1145</b>	
<b>Junior Knee Cap (small/black)</b>				<b>1150</b>	
<b>Junior Knee Cap (large/beige)</b>				<b>1151</b>	

### Otto Bock - Components

Description	Weight Limit	Product No.	
<b>Child's Rotatable AK Socket Adapter</b> <ul style="list-style-type: none"> <li>With (4) 506G3=M6 adjustment set screws</li> <li>Laminated into the socket</li> <li>Connects with components distally</li> </ul>	Up to 45 kg/99 lbs.	<b>4R110</b>	



**TiMed - Components**

Description	Weight Limit	Product No.	
<b>Titanium Adapter, 25mm to 30mm</b> <ul style="list-style-type: none"> <li>• 32 g</li> </ul>	300 lbs / 136 kg	<b>A-30-25</b>	
<b>Titanium Adapter, 25mm to 30mm</b> <ul style="list-style-type: none"> <li>• 49 g</li> </ul>	176 lbs / 80 kg	<b>A-25-30</b>	
<b>Aluminum Tube, 22mm</b> <ul style="list-style-type: none"> <li>• 105 g</li> <li>• Color: Red</li> <li>• Length: 13" (330 mm)</li> </ul>	99 lbs / 45 kg	<b>A-400B</b>	
<b>Carbon Fiber Tube, 22mm</b> <ul style="list-style-type: none"> <li>• 68 g</li> <li>• Length: 13" (330 mm)</li> </ul>	176 lbs / 80 kg	<b>A-422C</b>	
<b>4-Hole Connector with Pyramid</b> <ul style="list-style-type: none"> <li>• 59 g</li> </ul>	176 lbs / 80 kg	<b>P-192</b>	
<b>4-Hole Connector with Pyramid Receiver</b> <ul style="list-style-type: none"> <li>• 63 g</li> </ul>	176 lbs / 80 kg	<b>P-193</b>	
<b>Titanium Tube Clamp, 22mm Pyramid Receiver</b> <ul style="list-style-type: none"> <li>• 49 g</li> </ul>	150 lbs / 68 kg	<b>P-203A</b>	
<b>Aluminum Tube Clamp, 22mm</b> <ul style="list-style-type: none"> <li>• 49 g</li> <li>• Color: Orange</li> </ul>	99 lbs / 45 kg	<b>P-203B</b>	
<b>Small Double Ended Adapter, 32mm</b> <ul style="list-style-type: none"> <li>• 86 g</li> </ul>	176 lbs / 80 kg	<b>P-401</b>	
<b>Small Double Ended Adapter, 45mm (not pictured)</b> <ul style="list-style-type: none"> <li>• 80 g</li> </ul>	176 lbs / 80 kg	<b>P-402</b>	
<b>Small Double Ended Adapter, 60 mm</b> <ul style="list-style-type: none"> <li>• 84 g</li> </ul>	176 lbs / 80 kg	<b>P-403</b>	





**TiMed - 22 mm Components - Continued**

Description	Weight Limit	Product No.	
<b>Small Double Ended Adapter, 75 mm</b> • 86 g	176 lbs / 80 kg	<b>P-404</b>	
<b>Titanium Tube with Pyramid Receiver, 22 mm</b> • 72 g	176 lbs / 80 kg	<b>P-422</b>	
<b>Small 4-Hole Rotating Base</b> • 39 g	176 lbs / 80 kg	<b>P-502</b>	
<b>Small Titanium Rotating Pyramid</b> • 26 g	176 lbs / 80 kg	<b>P-505</b>	
<b>Small Titanium Rotating Pyramid Receiver</b> • 38 g	176 lbs / 80 kg	<b>P-506</b>	
<b>Small Titanium SACH Foot Adapter with M8 Bolt</b> • 50 g	176 lbs / 80 kg	<b>P-509</b>	
<b>Small 4-Ear Titanium Connector</b> • 34 g	176 lbs / 80 kg	<b>P-510</b>	
<b>22 mm Small Flexible 3-Ear Titanium Connector</b> • 45 g	176 lbs / 80 kg	<b>P-511-3</b>	
<b>25 mm Titanium Tube Clamp (not pictured)</b> • 48 g	176 lbs / 80 kg	<b>P-503</b>	
<b>Titanium Tube Clamp with standard 30 mm Pyramid Receiver, 22mm</b> • 65 g	150 lbs / 68 kg	<b>P-523</b>	







Pediatrics



**TiMed - 22 mm Components - Continued**

Description	Weight Limit	Product No.	
<b>Aluminum Pediatric Single Axis Knee</b> <ul style="list-style-type: none"> <li>• 183 g</li> <li>• Color: Orange</li> </ul>	99 lbs / 45 kg	<b>PK-100</b>	
<b>Aluminum Pediatric 4-Bar Knee</b> <ul style="list-style-type: none"> <li>• 176 g</li> <li>• Color: Blue &amp; Red</li> </ul>	120 lbs / 55 kg	<b>PK-400</b>	

**Trulife - Child's Play® System**

Description	Weight Limit	Product No.	
<b>Child's Play Foot Pyramid</b> <ul style="list-style-type: none"> <li>• Foot bolt not included (SFB544)</li> <li>• Titanium</li> <li>• 27 g</li> </ul>	120 lbs	<b>SCA297</b>	
<b>Child's Play SACH Foot Adapter</b> <ul style="list-style-type: none"> <li>• Includes 8 mm foot bolt</li> <li>• Aluminum</li> <li>• 67 g</li> </ul>	110 lbs	<b>P13035</b>	
<b>Child's Play 22 mm Clamp Adapter</b> <ul style="list-style-type: none"> <li>• Titanium</li> <li>• 35 g</li> </ul>	120 lbs	<b>SCA292</b>	
<b>Child's Play 22 mm Pyramid Clamp</b> <ul style="list-style-type: none"> <li>• Aluminum body with SS pyramid insert</li> <li>• Color: Blue</li> <li>• 40 g</li> </ul>	88 lbs	<b>P13025</b>	
<b>Child's Play 23 mm Variable Height Adapter</b> <ul style="list-style-type: none"> <li>• Titanium</li> <li>• 34 g</li> </ul>	120 lbs	<b>SCA293</b>	
<b>Child's Play 32 mm Variable Height Adapter</b> <ul style="list-style-type: none"> <li>• Titanium</li> <li>• 43 g</li> </ul>	120 lbs	<b>SCA294</b>	









Trulife - Child's Play® System			
Description	Weight Limit	Product No.	
<b>Child's Play 45 mm Variable Height Adapter</b> <ul style="list-style-type: none"> <li>• Titanium</li> <li>• 56 g</li> </ul>	120 lbs	<b>SCA295</b>	
<b>Child's Play 60 mm Variable Height Adapter</b> <ul style="list-style-type: none"> <li>• Titanium</li> <li>• 70 g</li> </ul>	120 lbs	<b>SCA296</b>	
<b>Child's Play 22 mm 4-hole Pyramid Adapter</b> <ul style="list-style-type: none"> <li>• For use with laminating block SLB240</li> <li>• Titanium</li> <li>• 48 g</li> </ul>	120 lbs	<b>SCA290</b>	
<b>Child's Play 22 mm Female Pyramid Receiver</b> <ul style="list-style-type: none"> <li>• 4-hole pattern may be mounted to laminating block SLB240</li> <li>• Aluminum</li> <li>• 54 g</li> <li>• Color: Blue</li> </ul>	88 lbs	<b>P13003</b>	
<b>Child's Play Knee</b> <ul style="list-style-type: none"> <li>• 4-Bar polycentric design</li> <li>• Friction swing control and extension spring assist</li> <li>• Height: 4" (11 cm)</li> <li>• 140° flexion</li> <li>• For long residual limbs, remove pyramid and use Symes Nut lamination adapter SSY303</li> <li>• Color: Blue &amp; Red</li> <li>• 55 g</li> </ul>	121 lbs	<b>SSK610A</b>	
<b>Child's Play 22 mm 4-Ear Socket Pyramid</b> <ul style="list-style-type: none"> <li>• Aluminum with SS pyramid insert</li> <li>• 41 g</li> <li>• Color: Orange</li> </ul>	110 lbs	<b>P13043</b>	
<b>Child's Play 22 mm x 12" Tube</b> <ul style="list-style-type: none"> <li>• Aluminum</li> <li>• 114 g</li> <li>• Color: Blue</li> </ul>	88 lbs	<b>P13010</b>	
<b>Child's Play Composite Flex 22 mm x 16" Pylon</b> <ul style="list-style-type: none"> <li>• 120 g</li> <li>• Color: Purple</li> </ul>	120 lbs	<b>SSL260-P3</b>	
<b>Child's Play Laminating Block</b> <ul style="list-style-type: none"> <li>• Rigid polyurethane foam surrounding a nylon core</li> <li>• Height: 1.3"; Diameter: 3.6"</li> <li>• 93 g</li> </ul>	144 lbs	<b>SLB240</b>	



**Trulife - Child's Play® System - Continued**

Trulife - Child's Play® System - Continued					
Description	Product Wt.	Sizes	Weight Limit	Product No.	
<b>Child's Play Ankle Block</b> <ul style="list-style-type: none"> <li>High strength rigid polyurethane foam surrounding a nylon core</li> <li>Height: 3.5"</li> </ul>	123 g	13-15 cm	69 lbs	<b>SAB311</b>	
	146 g	16-18 cm	89 lbs	<b>SAB312</b>	
	179 g	19-21 cm	144 lbs	<b>SAB313</b>	
<b>Child's Play Foot Spacer</b> <ul style="list-style-type: none"> <li>Permits access to alignment devices or use permanently to allow setup on existing limb systems</li> </ul>	<b>Height</b>	<b>Sizes</b>	<b>Weight Limit</b>	<b>Product No.</b>	
	6 mm (.25")	13-15 cm	69 lbs	<b>SFS240</b>	
	25 mm (1")	13-15 cm	69 lbs	<b>SFS241</b>	
	6 mm (.25")	16-18 cm	89 lbs	<b>SFS242</b>	
	25 mm (1")	16-18 cm	89 lbs	<b>SFS243</b>	
	6 mm (.25")	19-21 cm	144 lbs	<b>SFS244</b>	
30 mm (1.2")	19-21 cm	144 lbs	<b>SFS245</b>		
<b>Child's Play Laminating Core</b> <ul style="list-style-type: none"> <li>Alternative to the ankle block</li> <li>Laminates directly to the socket providing adaptation to the foot</li> </ul>	<b>Height</b>	<b>Sizes</b>	<b>Weight Limit</b>	<b>Product No.</b>	
	63 mm	13-15 cm	144 lbs	<b>SLC301</b>	
	79 mm	16-18 cm	144 lbs	<b>SLC302</b>	
	75 mm	19-21 cm	144 lbs	<b>SLC303</b>	
	<b>Height</b>	<b>Sizes</b>	<b>Weight Limit</b>	<b>Product No.</b>	
<b>Child's Play Symes Nut</b> <ul style="list-style-type: none"> <li>Abrasive etched finish of the aluminum ensures secure socket adhesion during fabrication</li> <li>Minimum clearance 4 cm (1.6")</li> </ul>	13 mm (0.5")	13-15 cm	69 lbs	<b>SSY301</b>	
		16-18 cm	89 lbs	<b>SSY302</b>	
		19-21 cm	144 lbs	<b>SSY303</b>	
			<b>Color</b>	<b>Product No.</b>	
<b>Child's Play Cosmesis</b> <ul style="list-style-type: none"> <li>Calf circumference 20 cm (10.25")</li> <li>Available for sizes 13 to 21 cm (specify when ordering)</li> <li>Specify side</li> </ul>			Caucasian	<b>SEC220</b>	
			Light Brown	<b>SEC221</b>	
			Dark Brown	<b>SEC223</b>	



WillowWood - P-POD™ Foundation Components		
Description	Product No.	
<b>Titanium Symes Nut</b> <ul style="list-style-type: none"> <li>Rated to 132 lbs</li> <li>30 g</li> </ul>	PPF-FS006	
<b>Laminated Socket Attachment Block</b> <ul style="list-style-type: none"> <li>Rated to 132 lbs</li> <li>33 g</li> </ul>	PPF-700250	
<b>4-Hole Titanium Pyramid</b> <ul style="list-style-type: none"> <li>Rated to 132 lbs</li> <li>30 g</li> </ul>	PPF-227014	
<b>4-Hole Aluminum Pyramid Receiver</b> <ul style="list-style-type: none"> <li>Rated to 132 lbs</li> <li>30 g</li> <li>Color: Blue</li> </ul>	PPF-137004	
<b>51 mm Aluminum Dual Receiver</b> <ul style="list-style-type: none"> <li>Rated to 132 lbs</li> <li>65 g</li> <li>Color: Blue</li> </ul>	PPF-138051	
<b>27 mm Aluminum Dual Receiver</b> <ul style="list-style-type: none"> <li>Rated to 132 lbs</li> <li>44 g</li> <li>Color: Blue</li> </ul>	PPF-138027	
<b>Aluminum Foot Pyramid Receiver</b> <ul style="list-style-type: none"> <li>Rated to 132 lbs</li> <li>35 g</li> <li>Color: Blue</li> </ul>	PPF-1209	
<b>Titanium Foot Pyramid Adapter</b> <ul style="list-style-type: none"> <li>Rated to 132 lbs</li> <li>15 g</li> </ul>	PPF-1208	
<b>Aluminum 22 mm Tube Clamp Adapter</b> <ul style="list-style-type: none"> <li>Rated to 132 lbs</li> <li>45 g</li> </ul>	PPF-130000	

Pediatrics



**WillowWood P-POD™ Foundation Components - Continued**

Description		Product No.		
<b>22 mm Aluminum Pylons</b> <ul style="list-style-type: none"> <li>• 300 mm/11.8" (91 g)</li> <li>• 400 mm/15.7" (160 g)</li> </ul>		<b>PPF-130030</b> <b>PPF-130040</b>		
<b>22 mm Pylons with Fixed Aluminum Adapter</b> <ul style="list-style-type: none"> <li>• 300 mm/11.8" (160 g)</li> <li>• 400 mm/15.7" (199 g)</li> </ul>		<b>PPF-131330</b> <b>PPF-131340</b>		
<b>1/4" 4-Hole Spacer Plates</b> <ul style="list-style-type: none"> <li>• 10 g</li> </ul>		<b>PPF-994114</b>		
<b>1/8" 4-Hole Spacer Plates</b> <ul style="list-style-type: none"> <li>• 5 g</li> </ul>		<b>PPF-994118</b>		
<b>Growth Plate Kit</b> <ul style="list-style-type: none"> <li>• Enables prosthesis to be lengthened without having to use a new pylon or adapters</li> <li>• Kit includes 1/8", 1/4", 1/2" and 1 foot bolt</li> </ul>		<b>PPF-GKIT</b>		
<b>1/8" Growth Plate</b>		<b>PPF-G125</b>		
<b>1/4" Growth Plate</b>		<b>PPF-G250</b>		
<b>1/2" Growth Plate</b>		<b>PPF-G500</b>		
<b>Exoskeletal Laminating Core</b> <ul style="list-style-type: none"> <li>• Color: Blue</li> </ul>		<b>PPF-1540</b>		
Description	Right Product No.	Left Product No.		
<b>P-POD™ Exoskeletal Ankle Block Sach 15-18 cm (small)</b>	<b>PPS-1518SR</b>	<b>PPS-1518SL</b>		
<b>P-POD™ Exoskeletal Ankle Block Sach 19-22 cm (large)</b>	<b>PPS-1922LR</b>	<b>PPS-1922LL</b>		
<b>P-POD™ Exoskeletal Ankle Block Impulse 15-18 cm (small)</b>	<b>PPI-1518SR</b>	<b>PPI-1518SL</b>		
<b>P-POD™ Exoskeletal Ankle Block Impulse 19-22 cm (large)</b>	<b>PPI-1922LR</b>	<b>PPI-1922LL</b>		



### ALPS - General Purpose (GP) Locking and Cushion Liners

- Distal end encapsulation retrofits most competitors' liners
- Slightly tacky feel reduces bunching in the popliteal region
- Warranty: one liner - 12 months, two liners - 24 months

Size	Product No.	
	3 mm Locking	6 mm Locking
16-19 cm	<b>GPDT16-3</b>	<b>GPDT16-6</b>
20-23 cm	<b>GPDT20-3</b>	<b>GPDT20-6</b>
24-25 cm	<b>GPDT24-3</b>	<b>GPDT24-6</b>
Please see the adult section for larger sizes.		

Size	Product No.	
	3 mm Cushion	6 mm Cushion
16-19 cm	<b>GPFR16-3</b>	<b>GPFR16-6</b>
20-23 cm	<b>GPFR20-3</b>	<b>GPFR20-6</b>
24-25 cm	<b>GPFR24-3</b>	<b>GPFR24-6</b>
Please see the adult section for larger sizes.		



GP Locking Liner

GP Cushion Liner

### Proximal Seal Interface (PSI) Liner

- Unlimited restriction of stretch on the proximal portion of the liner where there is no fabric
- Terry fabric acts as an air wick
- Works well with elevated vacuum systems currently available on the market
- Excellent redistribution of forces will soothe the skin
- Measurement is taken 6 cm up from the distal end
- Warranty: One liner, 12 months; two liners, 24 months

Size	Product No.	
	Tapered	6 mm
16-19 cm	<b>PSI16-6/3</b>	<b>PSI16-6</b>
20-23 cm	<b>PSI20-6/3</b>	<b>PSI20-6</b>
24-25 cm	<b>PSI24-6/3</b>	<b>PSI24-6</b>
Please see the adult section for larger sizes.		



### EasyLiner™ Fabric Reinforced Liner

- Combines the softness, strength and elasticity of the ALPS EasyGel offering comfort and durability
- Provides a lower coefficient of friction relieving the skin of any shear force
- Measurement is taken 6 cm up from the distal end
- 12 mm distal pad protects bony prominence
- Contains antioxidants that help with the skin healing process
- Warranty: one liner - 12 months, two liners - 24 months

EasyLiner™ Locking			
Size	3 mm Uniform	6 mm Uniform	6/3 mm Tapered
16-19 cm	<b>ELDT-16-3HP</b>	<b>ELDT-16-6HP</b>	<b>ELDT-16-6/3HP</b>
20-23 cm	<b>ELDT-20-3HP</b>	<b>ELDT-20-6HP</b>	<b>ELDT-20-6/3HP</b>
24-25 cm	<b>ELDT-24-3HP</b>	<b>ELDT-24-6HP</b>	<b>ELDT-24-6/3HP</b>

Please see the adult section for larger sizes.

EasyLiner™ Cushion			
Size	3 mm Uniform	6 mm Uniform	6/3 mm Tapered
16-19 cm	<b>ELFR-16-3</b>	<b>ELFR-16-6</b>	<b>ELFR-16-6/3</b>
20-23 cm	<b>ELFR-20-3</b>	<b>ELFR-20-6</b>	<b>ELFR-20-6/3</b>
24-25 cm	<b>ELFR-24-3</b>	<b>ELFR-24-6</b>	<b>ELFR-24-6/3</b>

Please see the adult section for larger sizes.

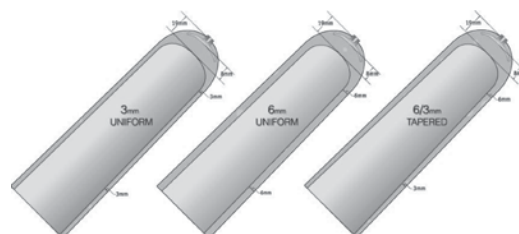

### EasyLiner™ Super Stretch

- Allows complete freedom of movement and at the same time achieves superior total contact with the skin without restricting blood flow
- Beneficial for scar and difficult-to-fit patients
- Measurement is taken 6 cm up from distal end
- Warranty: 6 months

Size	6 mm Uniform Product No.
10-15 cm	<b>ELPX-10</b>
16-19 cm	<b>ELPX-16</b>
20-23 cm	<b>ELPX-20</b>
24-25 cm	<b>ELPX-24</b>

Please see the adult section for larger sizes.



### Clearpro™

- Fabricated from transparent silicone, allowing constant observation of the residual limb
- Medical grade silicone allows freedom of movement with the added comfort of as little as 1.5 mm of material behind the knee
- Designed with additional silicone along the distal end to reduce pistoning and increase distal stabilization
- Measurement is taken 6 cm up from the distal end
- Warranty: 12 months

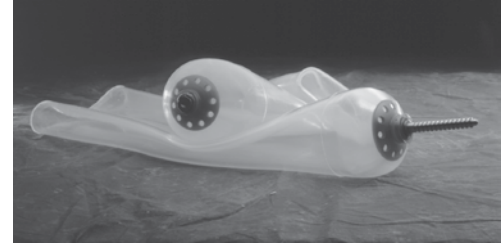

Size	Product No.	
	1.5 mm	3 mm
14-15 cm	<b>SSA14-1.5</b>	<b>SSA14-3.0</b>
16-17 cm	<b>SSA16-1.5</b>	<b>SSA16-3.0</b>
18-19 cm	<b>SSA18-1.5</b>	<b>SSA18-3.0</b>
20-21 cm	<b>SSA20-1.5</b>	<b>SSA20-3.0</b>
22-23 cm	<b>SSA22-1.5</b>	<b>SSA22-3.0</b>
24-25 cm	<b>SSA24-1.5</b>	<b>SSA24-3.0</b>
Please see the adult section for larger sizes.		

### Clear Gen™

- Fabricated from transparent silicone, allowing constant observation of the residual limb
- Available in two thicknesses and 6 sizes
- Measurement is taken 6 cm up from the distal end
- Warranty: 12 months

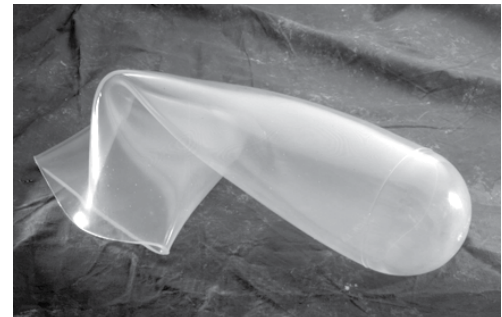

Size	Product No.	
	1.5 mm	3 mm
14-15 cm	<b>GL-14</b>	<b>GL-14-T</b>
16-17 cm	<b>GL-16</b>	<b>GL-16-T</b>
18-19 cm	<b>GL-18</b>	<b>GL-18-T</b>
20-21 cm	<b>GL-20</b>	<b>GL-20-T</b>
22-23 cm	<b>GL-22</b>	<b>GL-22-T</b>
24-25 cm	<b>GL-24</b>	<b>GL-24-T</b>
Please see the adult section for larger sizes.		

Pediatrics



**Thermoliner™ Custom Liner**

- Available in Locking or Cushion
- Easily customize and shape a gel interface to the configuration of the user
- Apply the Thermoliner over the positive and place it in the oven for 30 minutes at 194°F or 90°C and customization is complete
- Can be pulled on like a sock, making donning easier
- Gel durometer and contour provide additional control and support
- Softer version indicated BK's or bony AK's
- Measurement is taken 6 cm up from the distal end
- Warranty: one liner - 12 months, two liners - 24 months

Size	Product No.	
	3 mm Locking	6 mm Locking
16-19 cm	<b>TFDT16-3</b>	<b>TFDT16-6</b>
20-23 cm	<b>TFDT20-3</b>	<b>TFDT20-6</b>
24-25 cm	<b>TFDT24-3</b>	<b>TFDT24-6</b>
Please see the adult section for larger sizes.		

Size	Product No.	
	3 mm Cushion	6 mm Cushion
16-19 cm	<b>TFFR16-3</b>	<b>TFFR16-6</b>
20-23 cm	<b>TFFR20-3</b>	<b>TFFR20-6</b>
24-25 cm	<b>TFFR24-3</b>	<b>TFFR24-6</b>
Please see the adult section for larger sizes.		



**ESP - Aegis Ultimate Liner**

- Anatomically shaped for maximum comfort
- Pre-flexed design at 43°
- Newly formulated pure silicone gel; does not cold-flow; standard or T.S.B. mold modifications may be used
- Seamless fabric cover eases donning/doffing; reduces pistoning while stretching to accommodate wider limbs
- Uniform 6 mm thickness



Aegis Ultimate - Cushion Liner				
Limb Size	Liner Size	4"	6"	8"
14-20 cm	X-Small	<b>BKUXS4C</b>	<b>BKUXS6C</b>	<b>BKUXS8C</b>
20-26 cm	Small	<b>BKUS4C</b>	<b>BKUS6C</b>	<b>BKUS8C</b>
Please see the adult section for larger sizes.				

Aegis Ultimate - Locking Liner				
Limb Size	Liner Size	4"	6"	8"
14-20 cm	X-Small	<b>BKUXS4L</b>	<b>BKUXS6L</b>	<b>BKUXS8L</b>
20-26 cm	Small	<b>BKUS4L</b>	<b>BKUS6L</b>	<b>BKUS8L</b>
Please see the adult section for larger sizes.				





### Aegis Streamline Liner - Clear

- This silicone liner features the same anatomical shape as the Aegis Ultimate liner but in a uniform 2 mm wall thickness
- Pre-flexed at 43°
- 10-durometer pigment free silicone to minimize adverse skin reactions; 2 mm thickness
- The locking liner comes with threaded end and adapter nut to accept all current pin options
- Available lengths: 4", 6", 8" or 10" (10" only available in size 20 cm)
- Replace ? with desired length

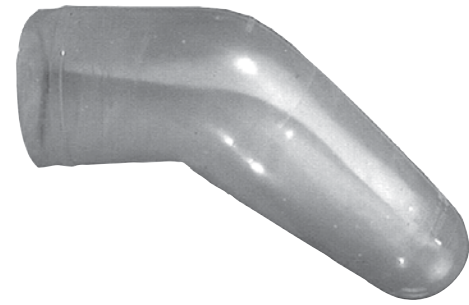

Limb Size	Liner Size	Product No.	
		Cushion	Locking
17-19 cm	14 cm	BK14?G	BK14?S
19-21 cm	16 cm	BK16?G	BK16?S
21-23 cm	18 cm	BK18?G	BK18?S
23-25 cm	20 cm	BK20?G	BK20?S

**To determine proper sizing:**

1. Take circumference measurement 2" (5-6 cm) proximal to distal end of residual limb.
2. Take length measurement from mid-patella tendon to distal end of residual limb.

### Aegis Streamline Liner- Covered

- Anatomically Shaped for maximum comfort
- Pre-flexed design at 43°
- Standard or T.S.B. mold modifications may be used; does not cold-flow
- Compatible with any locking system (free adapter included)
- Seamless fabric cover eases donning/doffing; reduces pistoning while stretching to accommodate wider limbs
- Uniform 2-3 mm thickness

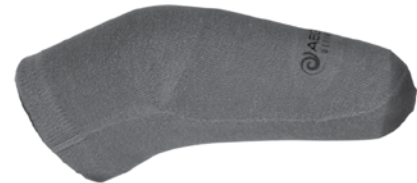

Limb Size/ Liner Size	Length	Product No.	
		Cushion Liner	Locking Liner
17-19 cm/ 14 cm	4"	BK144G-C	BK144S-C
	6"	BK146G-C	BK146S-C
	8"	BK148G-C	BK148S-C
	10"	—	—
19-21 cm/ 16 cm	4"	BK164G-C	BK164S-C
	6"	BK166G-C	BK166S-C
	8"	BK168G-C	BK168S-C
	10"	—	—
21-23 cm/ 18 cm	4"	BK184G-C	BK184S-C
	6"	BK186G-C	BK186S-C
	8"	BK188G-C	BK188S-C
	10"	—	—
23-25 cm/ 20 cm	4"	BK204G-C	BK204S-C
	6"	BK206G-C	BK206S-C
	8"	BK208G-C	BK208S-C
	10"	BK2010G-C	BK2010S-C

Please see the adult section for larger sizes.

**To determine proper sizing:**

1. Take circumference measurement 2" (5-6 cm) proximal to distal end of residual limb.
2. Take length measurement from mid-patella tendon to distal end of residual limb.



**Euro International - Assurance First Class**

- Medical grade silicone offers skin compatibility and comfort
- Durable bi-elastic single jersey fabric on the outside provides easy handling for your patient
- Offered in both tapered (6 mm distally to 2 mm proximally) and 6 mm uniform version; locking and cushion
- Alleviates pressure over bony prominences
- To select the correct size, measure the circumference of the residual limb approx. 4 cm from the distal end
- Sizes Available: 16, 18, 20, 22, 23.5
- Replace ? with size; please specify when ordering

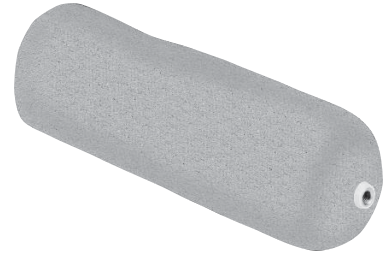

Description	Product No.	
	Cushion	Locking
1st Class 3 mm Tapered	5-EU-1S7-?	5-EU-1S5-?
1st Class + Uniform 6 mm	5-EU-1S8-?	5-EU-1S6-?
Please see the adult section for larger sizes.		

**Clear-Liner, Matrix 10**

- Made of top quality medical grade silicone
- The distal matrix reinforcement is essential for preventing pistoning
- To select the correct size, measure the circumference of the residual limb approximately 4 cm from the distal end
- Sizes Available: 12, 14, 16, 18, 20, 21, 22, 23.5
- See the adult section for larger sizes
- Replace ? with size; please specify when ordering



Description	Thickness	Product No.	
		Cushion	Locking
Two-Color	2 mm	—	5-1S18-?
Clearline	2.5 mm	5-1S2-?	5-1S1-?



### ContexGel Liner

- Streifeneder polymer Gel - SPG
- Uniform-styling
- 3 mm, 6 mm, and 9 mm available
- Easy rolling up through hard-wearing cover
- Thermoplastically deformable at 65°C
- To select the correct size, measure the circumference of the residual limb approx. 4 cm from the distal end

Size	Distal/ Proximal	Thickness	With Distal Connection	Without Distal Connection
Small	16-23 cm/ 25-36 cm	3 mm	<b>5-2S10-3S</b>	<b>5-2S11-3S</b>
Small	16-23 cm/ 25-36 cm	6 mm	<b>5-2S10-6S</b>	<b>5-2S11-6S</b>
Small	16-23 cm/ 25-36 cm	9 mm	<b>5-2S10-9S</b>	<b>5-2S11-9S</b>
Medium	18-30 cm/ 24-41 cm	3 mm	<b>5-2S10-3M</b>	<b>5-2S11-3M</b>
Medium	18-30 cm/ 24-41 cm	6 mm	<b>5-2S10-6M</b>	<b>5-2S11-6M</b>
Medium	18-30 cm/ 24-41 cm	9 mm	<b>5-2S10-9M</b>	<b>5-2S11-9M</b>

Please see the adult section for larger sizes.

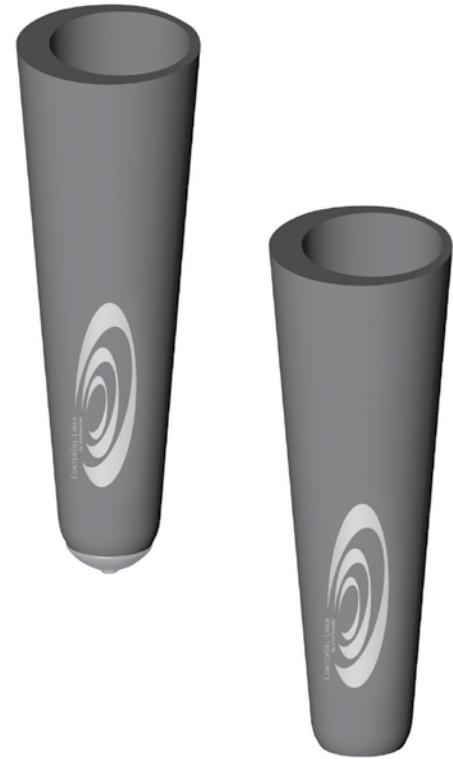

### Evolution - Chameleon Liner

- Specifically designed for kids - sizing and colors have been chosen for kids; electric blue, hot pink, neon green and fluorescent orange
- Available in both cushion and locking
- Matrix is standard in Chameleon locking liners and as a special order option in the cushion liners
- Silky surface allows the liner to slide on itself
- Unique medical grade silicone formula was specifically developed to ensure product quality and performance
- No cover to tear or run
- No coating to crack, peel or wear off

Circumference (inches)	Cushion Liner*	Locking Liner*
5 <sup>1</sup> / <sub>2</sub> " - 6 <sup>1</sup> / <sub>4</sub> "	<b>ECC-1</b>	<b>ECL-1</b>
6 <sup>1</sup> / <sub>4</sub> " - 7"	<b>ECC-2</b>	<b>ECL-2</b>
7" - 6 <sup>7</sup> / <sub>8</sub> "	<b>ECC-3</b>	<b>ECL-3</b>
7 <sup>7</sup> / <sub>8</sub> " - 8 <sup>3</sup> / <sub>4</sub> "	<b>ECC-4</b>	<b>ECL-4</b>

\*Specify color when ordering

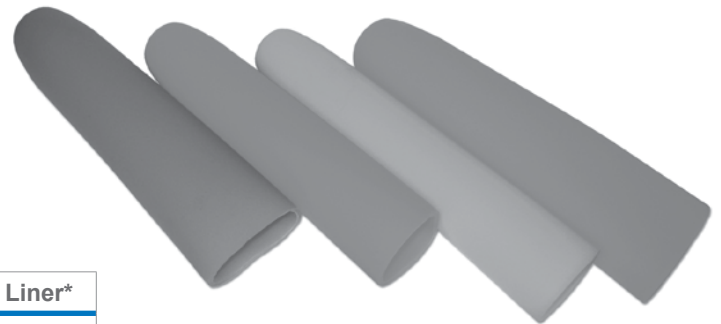

**Medi USA - Sensitive Liner**

- Designed for the transtibial amputee with standard or conical shaped limbs
- Soft silicone gel provides the ultimate in comfort and durability
- Available in 3 mm and 6 mm profiles
- Accommodates bony prominences as well as fleshy limbs
- Twelve sizing options
- Comfortable fit for the majority of transtibial amputees

Size	Product No.	
	3 mm	6 mm
18 cm	<b>M893118000</b>	<b>M893218000</b>
20 cm	<b>M893120000</b>	<b>M893220000</b>
22 cm	<b>M893122000</b>	<b>M893222000</b>
23.5 cm	<b>M893123000</b>	<b>M893223000</b>
Please see the adult section for larger sizes.		



*Every Medi liner comes with a distal plug and a locking pin adapter*

**Protect Care Liner**

- Protect Care silicone includes vitamin E, reduces adhesion, and allows easy donning and doffing
- Wall 2 mm thick, thicker distal wall, 10 cm matrix
- Fabric covered; can be used with and without the pin adapter
- Indicated for residual limbs with limitations due to skin problems

Size	Product No.
18 cm	<b>MC99118000</b>
20 cm	<b>MC99120000</b>
22 cm	<b>MC99122000</b>
23.5 cm	<b>MC99123000</b>
Please see the adult section for larger sizes.	



### RELAX and Plus RELAX Liner

- The Medi Liner RELAX is distinguished by its uniquely formulated silicone gel and the special materials used in its cover
- With its Umbrellan textile cover, long term effectiveness against phantom pain, is now possible without negative side effects
- This cover shields amputees who already have a disturbed nerve structure from electromagnetic influences around the limb

Size	Product No.	
	3 mm Relax	6 mm Plus Relax
18 cm	<b>M892118000</b>	<b>M892218000</b>
20 cm	<b>M892120000</b>	<b>M892220000</b>
22 cm	<b>M892122000</b>	<b>M892222000</b>
23.5 cm	<b>M892123000</b>	<b>M892223000</b>
25 cm	<b>M892125000</b>	<b>M892225000</b>
Please see the adult section for larger sizes.		



### RELAX Night Care Sock

- Umbrellan® for phantom pain, phantom sensations and idiopathic residual limb pain
- Clima-Comfort® material wicks moisture away from the skin
- Double-knitted fabric protects the residual limb from cold, slight impacts, friction, and other external influences
- 5 sizes for a wide range of transtibial and transfemoral limbs\*

Size	TT-Lower Circ.	TT-Upper Circ.	Length	TF Groin Circ.	Product No.
Small	18-23 cm	20-26 cm	40 cm	N/A	<b>1880322</b>
Medium	23-30 cm	26-33 cm	40 cm	26-33 cm	<b>1880323</b>
Please see the adult section for larger sizes.					



### Ossur - Iceross Junior Locking Liner

- Active skin care moisturizes and soothes skin
- Stabilizing matrix and umbrella minimizes pistoning
- Nylon outer cover offers good radial strength combined with comfortable elasticity (strong adhesion between silicone and cover)
- Indicated for young and users with sensitive skin engaging medium impact daily activities
- Children can decorate their liners and personalize them, there are 4 different colored permanent markers included with the liner
- Matrix: 10 cm
- 6 Month Warranty
- Replace ?? with size 12, 14, 16 or 18

Description	Product No.
3 mm Stabilo Junior	<b>I-8501??</b>
3 mm Dermo Junior	<b>I-8502??</b>



**WillowWood - Alpha<sup>®</sup> P-POD<sup>™</sup> Liners**

- Surrounds the residual limb in a layer of skin-friendly, mineral oil-based gel that contains Vitamin E and is heat-moldable
- Alpha P-POD Liners are sized with young amputees in mind bringing comfort to young amputees for the first time
- The new MAX fabric is three times more abrasion-resistant than many other liners on the market and helps to increase the durability around the trim lines and other common wear areas
- This liner is made for those who are highly active and require a heavy-duty liner and have proven to be ideal for children
- 12 month warranty



Size	Color	3 mm Uniform Product No.	
		Cushion	Locking
X-Small	Buff	<b>ALC-5839-E</b>	<b>ALL-5839-E</b>
X-Small +	Buff	<b>ALC-5832-E</b>	<b>ALL-5832-E</b>
X-Small	Med. Brown	<b>ALC-5939-E</b>	<b>ALL-5939-E</b>
X-Small +	Med. Brown	<b>ALC-5932-E</b>	<b>ALL-5932-E</b>

**Distance from Distal End**

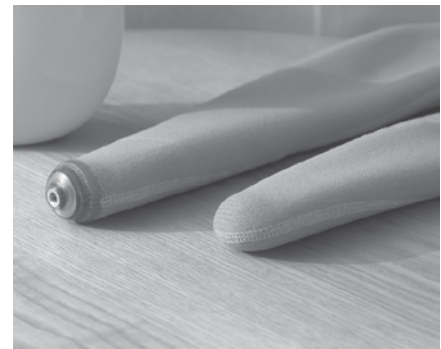
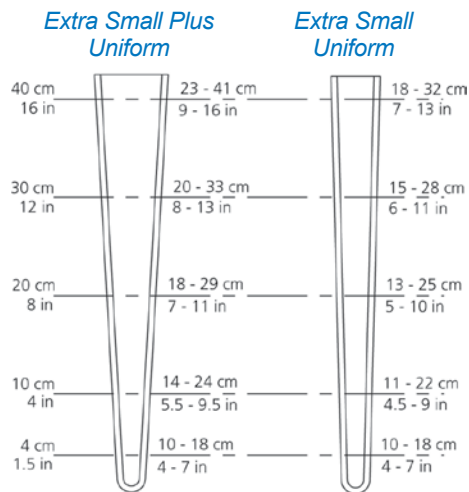

**Alpha<sup>®</sup> P-POD<sup>™</sup> Titanium Suction Pyramid**

- Recommended for laminated sockets
- Features a duckbill valve and works well with an Alpha Suction Seal to create a secure fit
- PPF-SP471 includes 1 suction pyramid, 1 porous plastic insert and 1 foam muffler. When buying PPF-SP470, you receive a laminated socket attachment block in addition to the above
- Patient weight limit is 132 lbs



Description	Product No.
Titanium 4-Hole Suction Pyramid	<b>PPF-SP471</b>
Titanium 4-Hole Suction Pyramid Kit	<b>PPF-SP470</b>
Duckbill Valve Only	<b>PPF-484</b>



### ALPS - Extreme Sleeve Fabric Reinforced

- Provides superior comfort due to ALPS GripGel™, which seals to the user's skin without creating shear forces
- Provides secure suspension by sealing against the skin without restricting circulation
- Available in 6 mm and 3 mm uniform thickness
- 3 month warranty

Size	Measurement (cm)	Product No.	
		6 mm	3 mm
XS	20-24	<b>SFK16-6</b>	<b>SFK16-3</b>
S	25-30	<b>SFK20-6</b>	<b>SFK20-3</b>

Please see the adult section for larger sizes.



### V.I.V.A Valve Integrated Vacuum Activated Sleeve

- Built in valve to evacuate the air in the socket
- Minimizes compression and irritation proximally
- The 6 mm is recommended for very active users
- Measurements taken 10 cm above patella
- Warranty: 3 months

Size	Measurement (cm)	Product No.	
		3 mm	6 mm
X-Small	20-24	<b>VIVA16-3</b>	<b>VIVA16-6</b>
Small	25-30	<b>VIVA20-3</b>	<b>VIVA20-6</b>

Please see the adult section for larger sizes.

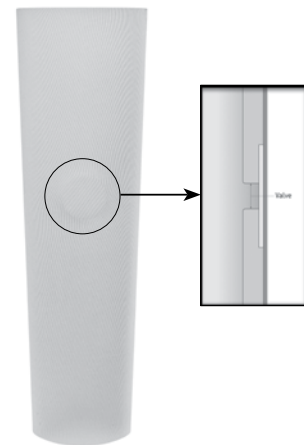

Pediatrics

### EasySleeve™ Fabric Reinforced

- Gel suction suspension sleeve with HP (high performance) fabric
- Elasticity of the fabric cover allows superior freedom of movement throughout knee flexion and while achieving a secure suspension by sealing against the skin without restricting circulation
- Also available in a sticky version
- Measurements taken 10 cm above patella
- Warranty: 3 months

Size	Measurement (cm)	Product No.	
		3 mm Uniform	6 mm Uniform
XXS	16-19	<b>SFR-10-3 HP</b>	<b>SFR-10-6 HP</b>
XS	20-24	<b>SFR-16-3 HP</b>	<b>SFR-16-6 HP</b>

Please see the adult section for larger sizes.



### EasySleeve™ Super Stretch

- Gel suction suspension sleeve — no fabric
- Allows complete freedom of movement and at the same time achieves superior secure suspension by sealing with the skin without restricting circulation
- Separate fabric cover keeps dirt and clothes away from gel
- Measurements taken 10 cm above patella
- Warranty: 3 months

Size	Measurement (cm)	Product No.	
		6 mm Uniform	Spandex Cover
XX-Small	10-15	<b>SLE-10</b>	—
X-Small	16-19	<b>SLE-16</b>	<b>CSLE-16</b>
Small	20-23	<b>SLE-20</b>	<b>CSLE-20</b>

Please see the adult section for larger sizes.



### Reinforced Clearline™

- Silicone suspension sleeve with fabric
- Elasticity of the fabric cover allows freedom of movement throughout knee flexion; secure suspension achieved by sealing against the skin without restricting circulation
- 1.5 mm Silicone with Lycra® Fabric
- Measurements taken 10 cm above patella
- Sizes: 28-37 cm; larger sizes available in adult section
- Custom sizes available
- Available in Beige, Brown and Black
- Warranty: 3 months

Size	Measurement (cm)	Product No.		
		Beige	Brown	Black
Small	28-32	<b>SLR-S</b>	<b>SLR-S-N</b>	<b>SLR-S-BLK</b>
Medium	33-34	<b>SLR-M</b>	<b>SLR-M-N</b>	<b>SLR-M-BLK</b>
Large	35-37	<b>SLR-L</b>	<b>SLR-L-N</b>	<b>SLR-L-BLK</b>

Please see the adult section for larger sizes.

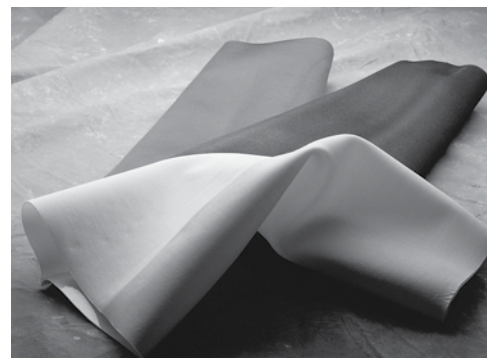



**Comfort Products - Endurance CRITERION**

- The Criterion features a smooth skin lining that gives superior comfort against the skin and reduces the chance for popliteal bunching
- For patients without strenuous activity levels, the Criterion is an excellent choice for comfort and durability
- Smoother feel; tougher and more durable neoprene material
- Rugged outer nylon cover; 15" length
- Manufactured using an intensive blind stitching and gluing process that greatly reduces seam failure



Size	Circ. 4" above KC	Product No.	
		Black	Beige
00	9-10"	<b>SUC00</b>	<b>SUCB00</b>
0	10 <sup>1</sup> / <sub>2</sub> -12"	<b>SUC0</b>	<b>SUCB0</b>

Please see the adult section for larger sizes.

**Endurance SPORT**

- The Sport has all the features of the Criterion with the added benefit of a nylon lined center section to reduce abrasion
- This design allows the sleeve to give excellent suspension in even the most demanding of conditions
- Smoother feel; tougher and more durable neoprene material
- Rugged outer nylon cover; 15" length
- Manufactured using an intensive blind stitching and gluing process that greatly reduces seam failure

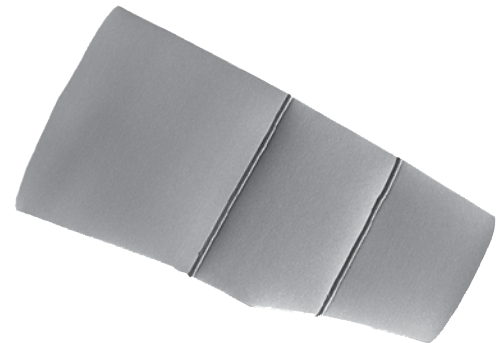

Size	Circ. 4" above KC	Product No.	
		Black	Beige
00	9-10"	<b>SUS00</b>	<b>SUSB00</b>
0	10 <sup>1</sup> / <sub>2</sub> -12"	<b>SUS0</b>	<b>SUSB0</b>

Please see the adult section for larger sizes.

**Endurance ZipSleeve**

- Zip Sleeves are made of a higher grade of neoprene than most of the neoprene suspension sleeves available on the market
- Has a smoother feel and is a much tougher and more durable neoprene material than others
- Has a rugged outer nylon cover; 15" length
- Manufactured using an intensive blind stitching and gluing process that greatly reduces seam failure



Size	Circ. 4" above KC	Product No.	
		Black	Beige
00	9-10"	<b>SUZ00</b>	<b>SUSZ00</b>
0	10 <sup>1</sup> / <sub>2</sub> -12"	<b>SUZ0</b>	<b>SUSZ0</b>

Please see adult section for larger sizes.

Pediatrics



**ESP - FlexiKids™**

- Suction suspension sleeve
- Maximizes comfort and freedom of movement
- Preflexed at 43°
- 1/8" latex-free neoprene
- Measure circumference 3"-4" above the patella
- Colors available: Chocolate Brown, Tan, or Black

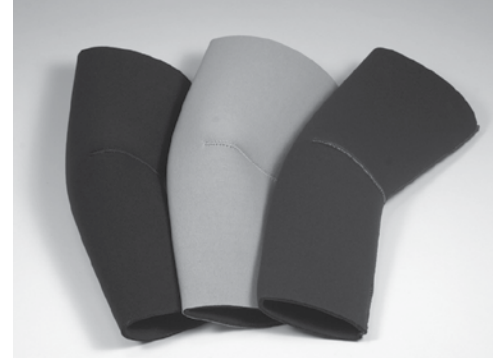

Size	Measurement	Product No.		
		Tan	Black	Chocolate Brown
X-Small	6" - 6 1/2"	<b>KS-ESP-XS-T</b>	<b>KS-ESP-XS-B</b>	<b>KS-ESP-XS-C</b>
Small	6 1/2" - 7 1/2"	<b>KS-ESP-S-T</b>	<b>KS-ESP-S-B</b>	<b>KS-ESP-S-C</b>
Medium	7 1/2" - 8 1/2"	<b>KS-ESP-M-T</b>	<b>KS-ESP-M-B</b>	<b>KS-ESP-M-C</b>
Large	8 1/2" - 9 1/2"	<b>KS-ESP-L-T</b>	<b>KS-ESP-L-B</b>	<b>KS-ESP-L-C</b>
X-Large	9 1/2" - 10 1/2"	<b>KS-ESP-XL-T</b>	<b>KS-ESP-XL-B</b>	<b>KS-ESP-XL-C</b>
XX-Large	10 1/2" - 11 1/2"	<b>KS-ESP-XXL-T</b>	<b>KS-ESP-XXL-B</b>	<b>KS-ESP-XXL-C</b>

**Euro International - Contex Gel Suspension Sleeve**

- High quality gel offers maximum strength and stretch
- Excellent memory
- Contoured proximally to distal to mimic anatomical shape
- No bulky seams at front of knee to limit knee flexion
- Upper circumference: 23-35 cm; Lower circumference: 15-23 cm; 36 cm length



Size	Product No.	
	Beige	Gray
Small	<b>3S10/S</b>	<b>3S10/S-G</b>
Please see the adult section for larger sizes.		



### New Options Sports - Hybrid™ Suspension

- Exclusively designed adjustable suspension for all pediatric below the knee amputees
- Circumferential Velcro strap to help prevent migration
- Protective knee pad for comfort and added longevity
- Adjustable Velcro posterior closure; Open popliteal for comfort
- Shark Skin material inside grips prosthesis for superior hold

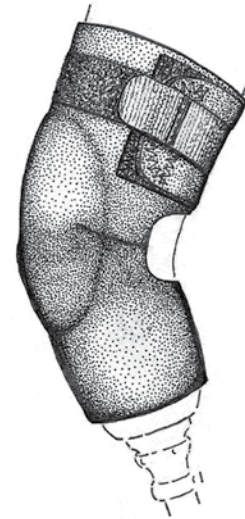

Size	Dimensions	Product No.
X-Small	6" - 6.6"	<b>PK77-XS</b>
Small	6.5" - 7.5"	<b>PK77-S</b>
Medium	7.5" - 8.5"	<b>PK77-M</b>
Large	8.5" - 9.5"	<b>PK77-L</b>
X-Large	9.5" - 10.5"	<b>PK77-XL</b>
XX-Large	10.5" - 11.5"	<b>PK77-XXL</b>
Circumference measurement 3" - 4" above knee		

### P.O.R. Inc. - Latex Rubber

- Dip molded, latex rubber
- Provides effective suspension
- Covers the border of the prosthesis and prosthetic sock
- To choose the proper size, measure leg circumference 5" above the knee to establish thigh size; length 13½"

Size	Thigh Size	Product No.
0	10½" - 12½"	<b>por0</b>
1	11½" - 13½"	<b>1</b>
Please see the adult section for larger sizes.		



### Heavy Duty Latex Rubber

- Dip molded, latex rubber
- Provides effective suspension
- Covers the border of the prosthesis and prosthetic sock
- To choose the proper size, measure leg circumference 5" above the knee to establish thigh size; length 13½"

Size	Thigh Size	Product No.
1	11½" - 13½"	<b>1HD</b>
1.5	13" - 14½"	<b>1.5HD</b>
Please see the adult section for larger sizes.		



**Silipos - DuraGel Suspension Sleeve**

- Easy to don and doff
- Mineral oil gel moisturizes and conditions the skin
- Made with DuraGel for added durability
- 3 mm gel thickness



Description	Product No
Suspension Sleeve	<b>18181</b>
Reinforced Sleeve	<b>18191</b>

DuraGel Sizing Guidelines		
	Proximal	Distal
Relaxed	9" (23 cm)	8" (20 cm)
Fully Stretched	15" (38 cm)	13" (33 cm)
Please see the adult section for larger sizes.		

**HD-BK Heavy Duty Suspension Sleeve™**

- Helps to prevent rotation while allowing full range of motion
- Does not bunch-up behind the popliteal area, and keeps skin conditioned
- Circumference: 11"-17"
- Length: 12" (30.5 cm)
- Size: 1

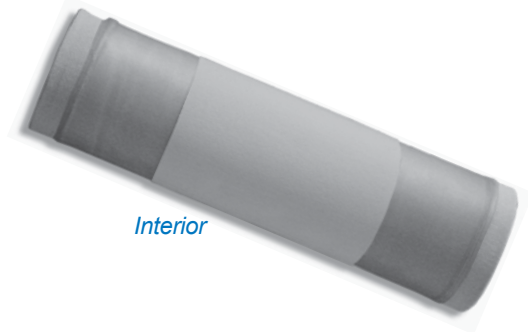

**Product No.** **1310**

**Arm Suspension Sleeve™**

- Helps to maintain suspension
- May be used as BK-Sleeve with children and small adult sizes
- Circumference: 8"-13" (20-30 cm)
- Length: 8<sup>3</sup>/<sub>4</sub>" (22 cm)



**Product No.** **13005**



**SPS - Neoprene**

- Constructed of 1/8" neoprene
- Nylon covering on one side
- Glued seam in front – no air leakage
- Contour shaped to knee
- Lasts longer than latex sleeves
- Beige color

Regular Knee Sleeve		
Size	Measurement	Product No.
0	10 <sup>1</sup> / <sub>2</sub> " - 12"	3530075200
1	12 <sup>1</sup> / <sub>4</sub> " - 14"	3530075300
1.5	13 <sup>1</sup> / <sub>2</sub> " - 15"	3530075350
Please see the adult section for larger sizes.		

Reinforced Knee Sleeve		
Size	Measurement	Product No.
0	10 <sup>1</sup> / <sub>2</sub> " - 12"	3530179200
1	12 <sup>1</sup> / <sub>4</sub> " - 14"	3530179300
1.5	13 <sup>1</sup> / <sub>2</sub> " - 15"	3530179350
Please see the adult section for larger sizes.		

Reinforced Knee Sleeve with Strap		
Size	Measurement	Product No.
0	10 <sup>1</sup> / <sub>2</sub> " - 12"	—
1	12 <sup>1</sup> / <sub>4</sub> " - 14"	3530207300
1.5	13 <sup>1</sup> / <sub>2</sub> " - 15"	—
Please see the adult section for larger sizes.		



Pediatrics

**Syncor - BK Durasleeve™**

- Sleeve is airtight
- No seam over patella
- No seam over stress prone area
- 15° initial flexion produces a contoured area for patella and increases sitting comfort and suspension during full extension
- Lycra® Reinforcement Panel reduces wear at socket to sleeve interface

Size	Measurement 4" Above Knee	Product No.
00	8" - 10"	DUR-A00
0	10" - 12"	DUR-000
1	12" - 14"	DUR-100
Please see the adult section for larger sizes.		



**Durasleeve EZ**

- Airtight hypobaric suction
- Friction control panel minimizes prosthetic wear
- Seamless pre-flexed knee reduces pressure on the patella

Size	Measurement 4" Above Knee	Product No.
X-Small (0)	11" - 12"	<b>DUR-EZ-0</b>
Small (1)	12" - 14"	<b>DUR-EZ-1</b>
Please see the adult section for larger sizes.		

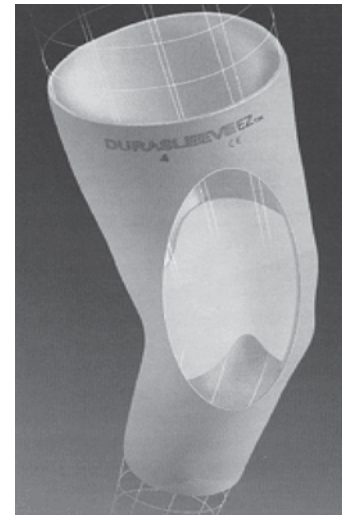

**Knit-Rite - Power Belt Auxiliary Suspension Belt™**

- Highly porous 1 mm thin material to keep patients cooler and minimize bulk, yet remain dynamically strong and durable
- The benefits of design and material application can expand the range of trans-femoral users who may benefit from improved body integration and prosthesis control from auxiliary suspension, during daily use or for selected activities, while minimizing objections encountered with other belts
- Adjustable Waist Left and Right with silicone gripper

Size	Waist	Fits Leg	Product No.	
			Right	Left
X-Small	21 - 28"	12 - 15+"	<b>3L928RXS</b>	<b>3L928LXS</b>
Small	23 - 30"	15 - 20+"	<b>3L928RSM</b>	<b>3L928LSM</b>
Please see the adult section for larger sizes.				



### Power Short Auxiliary Suspension Belt™

- Power Short Auxiliary Suspension Belt™ option, with continuous waist configuration, eliminates the bulk of Velcro closures and is preferred by some patients, especially those who are active
- The wearable stretch/compression range of the Power Short Auxiliary Suspension Belt™ is up to 8-10" in the waist and hip, depending on size and wearer preference
- Power Short is universal – for left or right application

Continuous Waist Plain Leg with Silicone Gripper				
Size	Waist/Hip Unstretched	Waist/Hip Circ.	Fits Leg	Product No.
X-Small	26/28"	28-36+"	12-15"	<b>3L911CXS</b>
Small	28/30"	30-38+"	15-20"	<b>3L911CSM</b>
Please see the adult section for larger sizes.				

Continuous Waist Adjustable Leg with Silicone Gripper				
Size	Waist/Hip Unstretched	Waist/Hip Circ.	Fits Leg	Product No.
X-Small	26/28"	28-36+"	14-21"	<b>3P911AXS</b>
Small	28/30"	30-38+"	16-22"	<b>3P911ASM</b>
Please see the adult section for larger sizes.				



### Cool-Flex AK Suspension Belt

- Gun-Slinger "Hip-Hugger" design of this suspension belt improves fit and comfort
- The Cool-Flex material is breathable, lets moisture out, and lets air in to keep the wearer cool and comfortable
- Universal design for either right or left application
- The Sure-Grip silicone suspension band effectively secures the prosthesis in place
- Reverse trimable Velcro attachment to waistband
- Proximal Brim measurement = 16-20" (40-50 cm)
- Size: Small (Please see the adult section for larger sizes)

Product No. **3LCFAKSM**

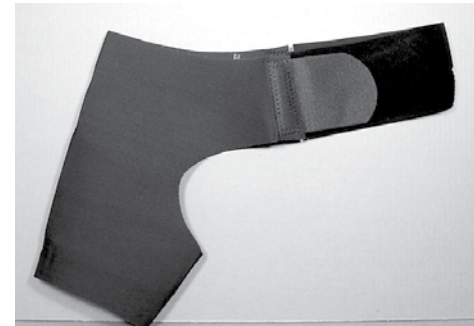

**Syncor - TES Belt (Total Elastic Suspension)**

- Total Elastic Suspension; Made of neoprene with nylon on the inside; Velcro compatible fabric on the outside
- Features a low profile, anti-roll, anti-bunch panel
- Cuff area has exposed textured neoprene on inside to securely grasp the socket

<b>Unilateral Belts</b>						
Size	<u>Socket Brim Circ.</u>		<u>Waist Measurement</u>		<u>Product No.</u>	
	Inches	Metric	Inches	Metric	Left	Right
Infant	9"-12"	23-30 cm	18"-22"	45-56 cm	<b>TES-INF-L</b>	<b>TES-INF-R</b>
Juvenile	11"-14"	28-36 cm	21"-26"	53-66 cm	<b>TES-JUV-L</b>	<b>TES-JUV-R</b>
X-Small	13"-17"	33-43 cm	27"-32"	68-81 cm	<b>TES-000-L</b>	<b>TES-000-R</b>
Small	16"-20"	41-51 cm	33"-41"	84-104 cm	<b>TES-100-L</b>	<b>TES-100-R</b>

Please see the adult section for larger sizes.

<b>Unilateral Belts with No Lateral Cutout</b>						
Size	<u>Socket Brim Circ.</u>		<u>Waist Measurement</u>		<u>Product No.</u>	
	Inches	Metric	Inches	Metric	Left	Right
Infant	9"-12"	23-30 cm	18"-22"	45-56 cm	<b>TES-INF-LN</b>	<b>TES-INF-RN</b>
Juvenile	11"-14"	28-36 cm	21"-26"	53-66 cm	<b>TES-JUV-LN</b>	<b>TES-JUV-RN</b>
X-Small	13"-17"	33-43 cm	27"-32"	68-81 cm	<b>TES-000-LN</b>	<b>TES-000-RN</b>
Small	16"-20"	41-51 cm	33"-41"	84-104 cm	<b>TES-100-LN</b>	<b>TES-100-RN</b>

Please see the adult section for larger sizes.

<b>Bilateral Belts</b>						
Size	<u>Socket Brim Circ.</u>		<u>Waist Measurement</u>		<u>Product No.</u>	
	Inches	Metric	Inches	Metric	Regular	No Lateral Cutout
Infant	9"-12"	23-30 cm	18"-22"	45-56 cm	<b>TES-INF-B</b>	<b>TES-INF-BN</b>
Juvenile	11"-14"	28-36 cm	21"-26"	53-66 cm	<b>TES-JUV-B</b>	<b>TES-JUV-BN</b>
X-Small	13"-17"	33-43 cm	27"-32"	68-81 cm	<b>TES-000-B</b>	<b>TES-000-BN</b>
Small	16"-20"	41-51 cm	33"-41"	84-104 cm	<b>TES-100-B</b>	<b>TES-100-BN</b>

Please see the adult section for larger sizes.

**ALPS - Mini-Valve**

- The Mini-Valve essentially is a one way expulsion valve releasing at approximately 1.5 psi, used to release any air trapped within the socket and the limb
- The mini-valve is very easy to use in both laminated and thermoplastic sockets
- Supplied with a rubber seal and a dummy plug for fabrication, and upon completion of fabrication the dummy plug is easily pushed out of the rubber seal and replaced with the valve



Product No.

**LMV-009**





### ESP - Lyn RV Slide

- Suction socket valve with reliable auto expulsion with the added feature of maintained, hands free, open operation
- Slide the operator button in any direction and the valve stays open for easy donning and doffing

Product No. **PA0400**



### Lyn Valve BK

- 1. Drill hole 2. Tap hole 3. Screw in valve
- New or retro-installation outside of socket
- Constructed of lightweight, durable plastic
- Low profile, 7/8" diameter
- Releases air at 1/2 psi without adjustment
- Optional threaded housing used for installation into soft thermoplastics



Description	Product No.
Lyn Valve BK	<b>PA0200</b>
Lyn Valve BK with Manual Release	<b>PA0202</b>
BK Valve threaded housing	<b>PA0222</b>
Disassembly Tool	<b>PA-PWSI-T</b>

### Pee Wee Valve

- Use with thermoplastic, blister molded sockets
- Manually operated expulsion
- Reusable installation tool, "The Fork"
- Optional threaded housing used for installation into soft thermoplastics

Description	Product No.
Pee Wee Valve	<b>PA0001</b>
"The Fork" for installation	<b>PA0009</b>
Pee Wee SI	<b>PA-PWSI</b>
Pee Wee SI threaded housing	<b>PA-PWSI-H</b>
Disassembly Tool	<b>PA-PWSI-T</b>

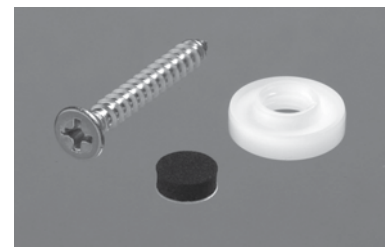

**Evolution Industries - Pediatric Valve Starter Kit**

- Is similar in content to the Adult Velocity Valve Starter Kit, except everything is sized specifically for Pediatrics
- If you have not purchased Pediatric Valves or Valve Kits from Evolution Industries previously, this should be included in your first purchase order
- The kit contains the Pediatric Valve Mounting Plate, Pediatric Expulsion Valve Housing, Pediatric Duckbill Valve, a Pediatric Valve Lamination Dummy, Pediatric Plate Lamination Dummy and Wrench

**Product No. PVV01-001**

**Pediatric Expulsion Valve Kit**

- Is similar in content, design and function to the Adult Expulsion Valve Kit

Description	Product No.
Pediatric Expulsion Valve Kit	<b>PVV01-002</b>
Pediatric Valve Mounting Plate	<b>PVMP-007</b>
Pediatric Expulsion Valve Housing	<b>PVV03-001</b>
Pediatric Duckbill Valve	<b>PVV03-003</b>

**Fillauer - Mini-Valve for Vacuum Sockets**

- Ideal for use with Silicone TEC or Alpha liners together with any type of air proof sleeve for below knee and knee-disarticulated amputees
- One way air flow

**Product No. 721000060**

**Trulife - Suction Socket Valve**

Description	Product No.
<b>Small Suction Socket Valve-SFS Style (Push)</b>	
Plastic Adjustable Leak Rate	<b>P19000008</b>
Plastic Non-Adjustable Leak Rate	<b>P19000009</b>
Housing Only	<b>P20276</b>
<b>Small Suction Socket Valve for Laminating (Push)</b>	
Aluminum Adjustable Leak Rate	<b>P19000005</b>
Aluminum Non-Adjustable Leak Rate	<b>P19000006</b>
Housing Only	<b>P20328</b>
<b>Small Suction Socket Valve with 2-part Housing (Push or Pull)</b>	
Plastic Adjustable Leak Rate	<b>P19000002</b>
Plastic Non-Adjustable Leak Rate	<b>P19000003</b>
Housing Only	<b>P20326</b>

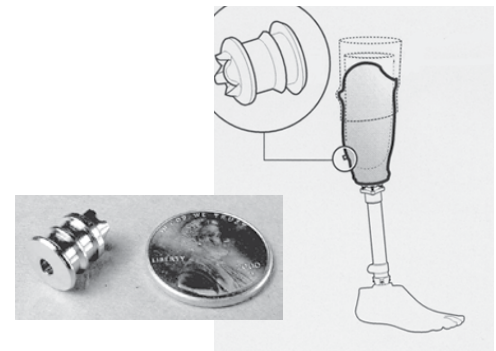

### Coyote Designs - Grommet Lock

- Ideal for pediatrics upper and lower extremity with easy engagement
- 1" cube in size, can be modified for areas with less space available
- Water resistant, durable, and lightweight
- 100 lb weight limit



Description	Product No.
Grommet lock with 10 mm threaded pin	<b>CD104TM</b>
Grommet lock with 6 mm threaded pin	<b>CD104SM</b>
Grommet Lock with 1/4 x 20" threaded pin	<b>CD104QT</b>
<b>Additional Pins</b>	
Pin with 10 mm threaded pin	<b>CD104P10</b>
Pin with 6 mm threaded pin	<b>CD104P6</b>
Pin with 1/4 x 20" threaded pin	<b>CD104PQ</b>

### Small Air-Lock™ with Pin

- Lock with suction valve built in for superior suspension
- Water resistant, lightweight, and very little wear
- One stage fabrication that separates pin and prosthetic alignment
- Accommodates small limb shapes and upper extremity
- Includes 1.3" standard pin and lamination dummy



Description	Product No.
Air-Lock Lock with Pin	<b>CD103S</b>
1.4" Lock Pin Only	<b>CD103P8</b>
1.6" Lock Pin Only	<b>CD103P9</b>

### Air-Lock Wrench

- Easy to use
- Makes lock maintenance fast and easy
- Equivalent to 13 mm deep well socket

Product No. **CD103WH**



**Aligned 4-Hole Connector**

- Separates pin and prosthetic alignments
- Improves lock function and eliminates need for offset connectors
- One stage fabrication in thermoformed or laminated sockets
- Pediatric Size

Product No. **CD103PAF**

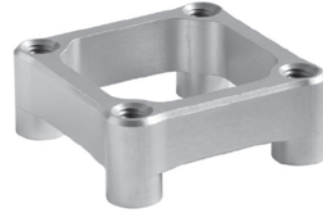

**Fast 4-Hole Connector**

- Creates quick and easy sockets with built-in 4-hole connector
- Fast four can be used multiple times in thermoformed sockets
- Can be fabricated in thermoformed or laminated sockets
- Pediatric Size

Product No. **CD103PFF**

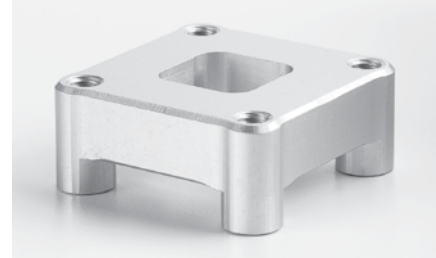

**Coyote Quick Adhesive**

- Easy to use
- 50 ml
- Sets up extremely fast with no sag, or smell
- Replaces methyl methacrylate for socket repair
- Used for Air-Lock fabrication and reinforcing socks for use with distal pins
- Dispensing gun and mix tips required (see below)

Product No. **CD4150**



**50 ml Dispensing Gun**

- Easy to use
- Drive design provides smooth operation and excellent control
- Easily operated with one hand to start and stop flow

Product No. **CDDMA51**



**Adhesive Mix Tips**

- Quad design mix tip reduces flow pressure and improves consistency of mixture
- Mix tip precisely combines the two component adhesive eliminating the need for hand mixing
- Allows you to dispense the exact amount of adhesive desired, reducing waste

Description	Product No.
6 Pack	<b>CD401</b>
20 Pack	<b>CD402</b>



**Fillauer - MightyMite® Shuttle Locks**

- Small, rugged design for active lightweight amputees
- Tested to 132 lbs
- Removable locking mechanism for easy service and replacement
- Thermoforming or lamination options
- Compatible with 22 mm endoskeletal systems

Description	Product No.
Cylindrical Housing Modular Shuttle Lock (Does not include Plunger)	<b>FC100204</b>
Titanium Pyramid Modular Shuttle Lock (Does not include Plunger)	<b>FC100202</b>
1" Plunger 1/4-20 thread	<b>809826</b>
1 1/2" Plunger 1/4-20 thread	<b>809827</b>
1" Plunger metric thread	<b>809826mm</b>
1 1/2" Plunger metric thread	<b>809827mm</b>
Fabrication Kit	<b>125420</b>



**Small Modular Shuttle Lock with Delrin Housing**

- For pediatrics, upper extremities and select light duty transtibials
- Weight limit: 220 lbs

Description	Product No.
Small Modular Shuttle Lock w./ Delrin Housing (Includes 1" Plunger)	<b>125410</b>
Small Modular Shuttle Lock w./ Delrin Housing (Includes 1 1/2" Plunger)	<b>125412</b>
1" Plunger metric thread	<b>809826mm</b>
1 1/2" Plunger metric thread	<b>809827mm</b>
Fabrication Kit	<b>125420</b>

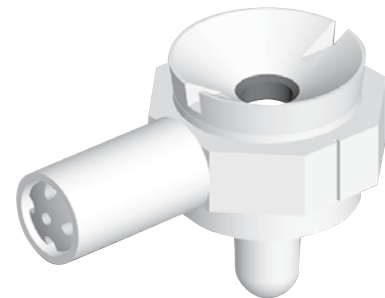

***KISS - Pediatric Delrin KISS® Kit***

- Features a delrin distal base which can be laminated into a socket or vacuum formed in a flexible inner socket
- Includes an aluminum tab to assist in fabrication
- Designed for a 1 socket, 2 liner application
- Total build height: 3 mm

***Pediatric 4-Hole Endo KISS® Kit***

- Features an aluminum 4-hole distal base which also serves as an attachment base for endoskeletal componentry
- Easily retrofits with PDI and Bulldog shuttle locks
- Designed for a 1 socket, 2 liner application
- Total build height: 3 mm



*Pediatric Delrin KISS Kit*

Description	Product No.
Delrin KISS Kit	<b>PKS1/A</b>
4-Hole Endo KISS Kit	<b>PKS2/A</b>
<b>Kit Includes:</b>	
Delrin Distal Base for PKS1/A	<b>PCMP1/A</b>
4-Hole Endo Distal Base for PKS2/A	<b>PCMP2/A</b>
Pediatric Adhesive Placard Set (1)	<b>PCMP5/A</b>
Pediatric Velcro Placard Set (1) (includes Ped. Proximal Nuts & Screws)	<b>PCMP22/A</b>
Pediatric Proximal Strap Set (1)	<b>PCMP7/A</b>
Pediatric Distal Strap Set (1)	<b>PCMP6/A</b>
Pediatric Distal Screw Set (1)	<b>PCMP8/A</b>
Pediatric KISS® Muffler Set (1)	<b>PCMP9/A</b>
10 mm - 6 mm Distal Threaded Insert (1)	<b>PCMP15/A</b>



*Pediatric 4-Hole Endo KISS Kit*



### Ossur - Icelock<sup>®</sup> 700 Series, Small

- Ratchet lock without distal adapter designed to be used in conjunction with Upper Extremity and Pediatric liners
- Extremely low build height and lightweight
- Very strong and durable
- Removable from inside of socket
- Reusable fabrication tools
- 1 Year Warranty

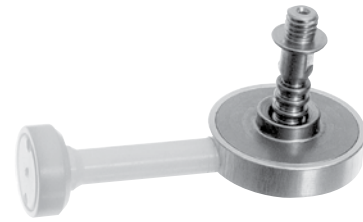

Description	Weight Rating	Product No.
Icelock Ratchet 721 Small		<b>L-721000</b>
<b>Lock Adapters</b>		
Stainless Steel Pyramid	99 lbs	<b>L-773000</b>
Alloy 4-hole Adapter	99 lbs	<b>L-774000</b>
<b>Accessories</b>		
Ratchet Attachment Pin Small		<b>L-792100</b>
Fabrication Tooling Kit		<b>L-780000</b>

### WillowWood - Mini G-Lock

- Designed to meet the needs of upper extremity and pediatric amputees
- Weight limit: 132 lbs
- Standard pin locking mechanism with pin seal; secures locking pin at nearest groove
- Use in Exoskeletal and Endoskeletal prostheses; only use in laminated sockets



**Product No.** **700-MGL480**

Pediatrics



**Comfort Products - Regal Acrylic Prosthetic Sock**

- The Regal™ Acrylic prosthetic sock is made of 98% acrylic and 2% Lycra
- It is a very soft stretchable sock which provides the patient with the latest advancement in fiber technology and knitting methods
- With the combination of fibers it gives a degree of stretch and conformance for the residual limb not possible with other fibers while wicking away moisture to ensure greater comfort
- Can be machine washed and dried in the dryer on delicate cycles
- To order, replace ? with desired ply
- Add 3 to product number for sock with hole in distal end
- Available by special order in 2 ply, 4 ply and 7 ply. Special order sizes from XX-Short to XX-Long and XX-Wide available, as well as a Wide/Mid Length size



Regal Sock (3 Ply, 5 Ply, and 6 Ply Weight)								
Size	Fits Current Size	Length		Top		Toe		Product No.
		In.	cm	In.	cm	In.	cm	
Narrow X Short	00, 0, A0, A1	8-10	20-25	4-6	10-15	3-3½	7.6-9	<a href="#">PSRNAXS?</a>
Narrow Short	00, 0, A0, A1	10-12	25-30	4-6	10-15	3-3½	7.6-9	<a href="#">PSRNASH?</a>
Narrow Regular	00, 0, A0, A1	14-16	35-40	4-6	10-15	3-3½	7.6-9	<a href="#">PSRNARG?</a>
Narrow Long	00, 0, A0, A1	18-20	45-50	4-6	10-15	3-3½	7.6-9	<a href="#">PSRNALG?</a>
Narrow X Long	00, 0, A0, A1	22-24	55-60	4-6	10-15	3-3½	7.6-9	<a href="#">PSRNAXL?</a>
Please see the adult section for larger sizes								

**Knit-Rite - Sterling Stretch Wash & Wear Prosthetic Sock**

- The sterling Stretch sock adds Lycra Spandex to the acrylic to allow the sock to conform to the shape of the limb better
- Fleecing adds softness to the inside next to the skin
- Available in 3, 5 and 6 ply weight
- Wash and wear stretch
- Conforms to shape of limb
- Transports moisture from skin
- Reinforced toe
- To order, replace ? with desired ply



Sterling Stretch Sock								
Size	Fits Current Size	Length		Top		Toe		Product No.
		In.	cm	In.	cm	In.	cm	
Narrow X Short	00, 0, AS, AL	8-10	20-25	4-6	10-15	3-3½	7.6-9	<a href="#">1SS?NAXS</a>
Narrow Short	00, 0, AS, AL	10-12	25-30	4-6	10-15	3-3½	7.6-9	<a href="#">1SS?NASH</a>
Narrow Regular	00, 0, AS, AL	14-16	35-40	4-6	10-15	3-3½	7.6-9	<a href="#">1SS?NARG</a>
Narrow Long	00, 0, AS, AL	18-20	45-50	4-6	10-15	3-3½	7.6-9	<a href="#">1SS?NALG</a>





### Knit-Rite - Soft Sock Cuddly N'Soft

- Full fashion knit sock made of CoolMax®/Lycra spandex in easy-to-fit sizes
- The fiber wicks moisture away from skin
- The skin remains drier and more comfortable
- Soft-Sock feels soft and cuddly worn next to the skin



Soft Sock Regular							
Size	Fits Current Size	Length		Product No.		Product No.	
		In.	cm	1 Ply	3 Ply	5 Ply	6 Ply
Child X Short	A	6	15	<b>1SP1CHXS</b>	—	—	—
Child Short	A	8	20	<b>1SP1CHSH</b>	<b>1SP3CHSH</b>	<b>1SP5CHSH</b>	<b>1SP6CHSH</b>
Child Medium	A	12	30	<b>1SP1CH12</b>	<b>1SP3CH12</b>	<b>1SP5CH12</b>	—
Narrow Short	B, 0, 1	10-14	25-35	<b>1SP1NASH</b>	<b>1SP3NASH</b>	<b>1SP5NASH</b>	<b>1SP6NASH</b>
Narrow Medium	B, 0, 1	16-20	40-50	<b>1SP1NAMD</b>	<b>1SP3NAMD</b>	<b>1SP5NAMD</b>	<b>1SP6NAMD</b>
Narrow Long	B, 0, 1	22-28	55-70	<b>1SP1NALG</b>	<b>1SP3NALG</b>	<b>1SP5NALG</b>	<b>1SP6NALG</b>

Please see adult section for larger sizes

Soft Sock Hole-In-Toe							
Size	Fits Current Size	Length		Product No.		Product No.	
		In.	cm	1 Ply	3 Ply	5 Ply	6 Ply
Child X Short	A	6	15	<b>1SPSCHXS</b>	—	—	—
Child Short	A	8	20	<b>1SPSCHSH</b>	<b>1SP3SCSH</b>	<b>1SP5SCSH</b>	<b>1SP6SCSH</b>
Narrow Short	B, 0, 1	10-14	25-35	<b>1SPSNASH</b>	<b>1SP3SNSH</b>	<b>1SP5SNSH</b>	<b>1SP6SNSH</b>
Narrow Medium	B, 0, 1	16-20	40-50	<b>1SPSNAMD</b>	<b>1SP3SNMD</b>	<b>1SP5SNMD</b>	<b>1SP6SNMD</b>

Please see adult section for larger sizes

### Spacer Socks

- This 1-ply sock has a reciprocal toe that has the seam one inch up from the distal end (like a sheath)
- Toe is rounded and reinforced for good fit and long wear
- Blended cotton polyester fabric is soft, comfortable and absorbent
- Prewashed so size remains true wash after wash
- Machine wash, tumble dry
- 6 per package



Weight	Fits Sizes	Length	Product No.
Narrow lightweight	#B, #0	15"	<b>6S-8035-LT</b>
Narrow heavyweight	#B, #0	15"	<b>6S-8035-HV</b>

Please see adult section for larger sizes



### Stretch Spacer Socks

- Made of cotton/Lycra spandex/nylon
- Like the original Spacer Socks, they feature a very soft and smooth cotton finish with a durable sheath type nylon toe
- Elasticity allows over 50% greater range than non-elastic version
- 6 per package

Size	Fits Sock		Product No.	
	Sizes	Length	Regular	Hole-In-One
Narrow	A,B	12"	<b>6S-8S35-MD</b>	<b>6S-SS35-MD</b>
Medium	0, 1	15"	<b>6S-8S40-MD</b>	<b>6S-SS40-MD</b>
Please see adult section for larger sizes				



### X-Wool™ Prosthetic Sock

- A blend of wool, lycra, and featuring X-Static™ — the Silver Fiber, a performance fiber system made with pure silver
- Silver is naturally antimicrobial, enabling X-Static to safely inhibit the growth of odor causing bacteria
- Silver also has the best possible thermodynamic properties, so the patient stays cooler in the summer and warmer in the winter
- Absorbent virgin wool is thick and cushioning. Lycra allows garment to contour without stretching out and accommodates flexion
- Fleece to add softness
- Machine washable, resists shrinkage



Size	Fits Sock		Product No.	
	Sizes	Length	3 Ply	5 Ply
Narrow X-Short	00, 0, AS, AL	8-10"	<b>1WX3NAXS</b>	<b>1WX5NAXS</b>
Narrow Short	00, 0, AS, AL	10-12"	<b>1WX3NASH</b>	<b>1WX5NASH</b>
Narrow Regular	00, 0, AS, AL	14-16"	<b>1WX3NARG</b>	<b>1WX5NARG</b>
Please see adult section for larger sizes				

### Power Tube Prosthetic Pull Sock

- A lower-friction donning sock
- Open on both end

Size	Max. Circumference	Product No.
X-Small	16"	<b>3M-PT08-XS</b>
Small	20"	<b>3M-PT10-SM</b>



### Power Pull Donning Sock

- Made of slicker, more supple fabric for easier donning
- Single-piece integral design provides a more direct and effective pull transfer and eliminates stress points for a more durable product

Size	Top	Proximal Circum.	Product No.
Size A	4"	less than 8"	<b>3MPP04AS</b>
Size B	6"	8-12"	<b>3MPP06BS</b>
X-Small	8"	12-16"	<b>3MPP08XS</b>
Small	10"	16-20"	<b>3MPP10SM</b>



### New Style Sheaths

- 100% Stretch Nylon permits a given sheath size to cover a range of prosthetic sock sizes
- Size range accommodates prosthetic sock sizes A (arm) through AK sizes 4, 5, or wider
- 3 pair per box

Description	Size	Product No.	
		White	Dusk
Child Short	A	<b>2HPWCHSH</b>	<b>2HPBCHSH</b>
Child 12"	A	<b>2HPWCH12</b>	<b>2HPBCH12</b>
Narrow Short	B, 0, 1	<b>2HPWNASH</b>	<b>2HPBNASH</b>
Narrow Medium	B, 0, 1	<b>2HPWNAMD</b>	<b>2HPBNAMD</b>
Narrow Long	B, 0, 1	<b>2HPWNALG</b>	<b>2HPBNALG</b>
Please see adult section for larger sizes			
<b>Hole-in-Toe Sheath</b>			
Narrow Short	B, 0	<b>2HPWNHSH</b>	<b>2HPBNHSH</b>
Regular Short	1, 2	<b>2HPWRHSH</b>	<b>2HPBRHSH</b>



Pediatrics



**Silipos - Silosheath Original**

- 2 ply, 2 mm gel
- Minimizes skin breakdown
- Reduces friction, shearing and abrasion on residual limb
- Cushions and protects
- Softens, soothes and improves the appearance of skin
- Product is washable and reusable

**Double Cushion Silosheath™**

- 2 ply, 3 mm gel, extra gel at distal end
- Minimizes skin breakdown
- Reduces friction, shearing and abrasion on residual limb
- Cushions and protects
- Softens, soothes and improves the appearance of skin
- Product is washable and reusable

**Silosheath Extra Life™**

- 3 ply, 2 mm gel, increased durability
- Minimizes skin breakdown
- Reduces friction, shearing and abrasion on residual limb
- Cushions and protects
- Softens, soothes and improves the appearance of skin
- Product is washable and reusable



Size	Gel Length	Approx. Length	Approx. Distal Circ.	Approx. Proximal Circ.	Original	Double Cushion	Extra Life
1	8" (20 cm)	10"-13" (25-33 cm)	6 1/2"-9" (17-23 cm)	6 1/2"-10" (17-25 cm)	<b>92815</b>	<b>13415</b>	<b>13815</b>
Please see adult section for larger sizes							

**STS - AFO Casting Socks**

- Designed for use in obtaining lower extremity molds of children
- Available in 4 sizes to cover a broader range of anatomy and ages
- Impressions are as accurate as plaster of Paris
- Easily removed with small scissors; Cast cutter not needed
- Glass-smooth finish is ideal for CAD/CAM
- Can be shipped with little chance of damage to central fab; ideal for custom pediatric AFOs

Size	Foot Length	Heel to Sock Top	Product No.
Small	3 1/2"	4"	<b>904-S</b>
Medium	4"	5"	<b>904-M</b>
Large	4 1/2"	6 1/2"	<b>904-L</b>
X-Large	5 1/2"	7 1/2"	<b>904-XL</b>



### Knit-Rite - Compressogrip Elastic Shrinkers

- Tubular elastic compression material for control or prevention of edema following amputation surgery
- Speeds fabrication, fitting and delivery of a prosthesis by uncomplicating application of an elastic bandage
- Approximate single layer pressure at 50% stretch is 20-25 mmHg
- At 100% stretch, compression is doubled. Doubled layers will double compression at both 50% and 100% stretch
- Applications of more than two layers should be monitored as compression may exceed the limits of desired therapeutic pressure
- 92% polyester, 8% spandex; Latex free

Size	Length	Circ.	Product No.	
			White	Beige
2	18"	5"-7"	<b>2H0S0218</b>	<b>2H0B0218</b>
2	24"	5"-7"	<b>2H0S0224</b>	<b>2H0B0224</b>
2 <sup>1</sup> / <sub>2</sub>	18"	7"-10"	<b>2H0S0S18</b>	<b>2H0B0S18</b>
2 <sup>1</sup> / <sub>2</sub>	24"	7"-10"	<b>2H0S0S24</b>	<b>2H0B0S24</b>

Please see adult section for larger sizes

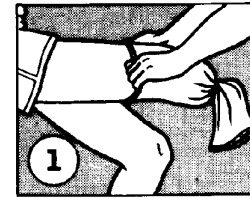

1 APPLY THE FIRST LAYER

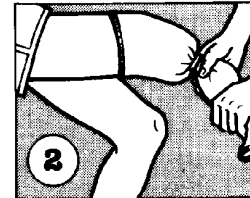

2 POSITION THE RING SNUGLY

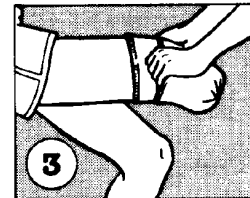

3 APPLY THE SECOND LAYER TO A POINT OF DESIRED MAXIMUM COMPRESSION.

### Compressogrip Tubular Elastic Bandage

- Proven effective for: Edema reduction and control
- Interim control of hypertrophic scarring following burn injury
- Dressing and monitoring device retention
- Smoothing irregularities when casting
- Wide range of sizes; cost effective
- All sizes provided in 11 yard (10 meter) rolls
- 92% polyester, 8% spandex
- Machine wash and dry, warm, no bleach
- Fabric will relax 20% in length after first washing

Size	Circ.	Product No.	
		White	Beige
2"	5"-7"	<b>6S762802</b>	<b>6S763102</b>
2 <sup>1</sup> / <sub>2</sub> "	7"-10"	<b>6S7628S2</b>	<b>6S7631S2</b>
2 <sup>3</sup> / <sub>4</sub> "	8"-11"	<b>6S7628T2</b>	<b>6S7631T2</b>

Please see adult section for larger sizes



**Hosmer - Child Size Hook- Model 12P**

- Stainless steel, canted fingers, plastisol coated
- 2<sup>3</sup>/<sub>4</sub>" (7 cm) long; 3 oz (85 g)
- Available in brown and Caucasian colors
- Standard 1/2" - 20 thread

Description	Product No.	
	Left	Right
12P Caucasian	<b>55056</b>	<b>55057</b>
12PN Brown	<b>54281</b>	<b>54282</b>



**Child Size - Model 10X**

- Aluminum, canted fingers, nitrile rubber lined
- 3<sup>3</sup>/<sub>8</sub>" (8.6 cm) long; 3 oz (85 g)
- Standard 1/2" - 20 thread

Description	Product No.	
	Left	Right
10X Hook	<b>55053</b>	<b>55054</b>



**Child Size - Model 10P**

- Aluminum, canted fingers, plastisol coated
- 2<sup>1</sup>/<sub>4</sub>" (8.6 cm) long; 3.5 oz (99 g)
- Available in brown and caucasian colors
- Standard 1/2" - 20 thread

Description	Product No.	
	Left	Right
10P Caucasian	<b>55050</b>	<b>55051</b>
10PN Brown	<b>54283</b>	<b>54284</b>



**Small Adult Size - Model 99X**

- Aluminum, canted fingers, nitrile rubber lined
- 3<sup>7</sup>/<sub>8</sub>" (9.8 cm) long; 3 oz (85 g)
- Standard 1/2" - 20 thread

Description	Product No.	
	Left	Right
99X Hook	<b>55043</b>	<b>55044</b>

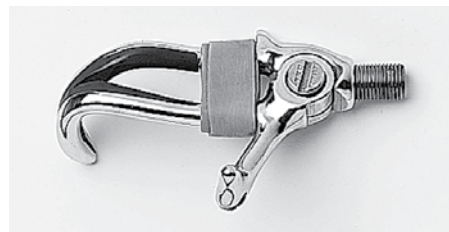

### Small Adult Size - Model 99P

- Aluminum, canted fingers, plastisol coated
- 3<sup>7</sup>/<sub>8</sub>" (9.8 cm) long; 3.5 oz (99 g)
- Available in brown and caucasian colors
- Standard 1<sup>1</sup>/<sub>2</sub>" - 20 thread

Description	Product No.	
	Left	Right
99P Caucasian	52946	53604
99PN Brown	56871	56872

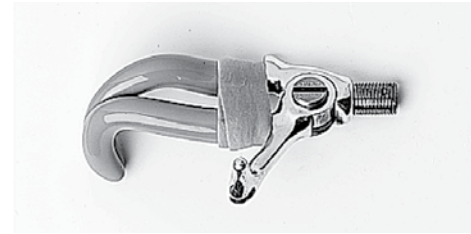

### UCLA CAPP Terminal Device

- Child size, sturdy alternative terminal device
- Wider palmar face and resilient friction cover for secure prehension
- Fits right or left with center or outside pull; available in Caucasian and Dark brown
- Soft, regular or heavy duty prehension springs are easily interchanged with an installation tool
- 1<sup>1</sup>/<sub>2</sub>" - 20 thread stud; length: 2<sup>15</sup>/<sub>16</sub>" (7.47 cm); 3 oz (85 g)
- Base diameter 1<sup>1</sup>/<sub>2</sub>" (3.8 mm); thumb opening 2<sup>5</sup>/<sub>8</sub>" (6.7 cm)

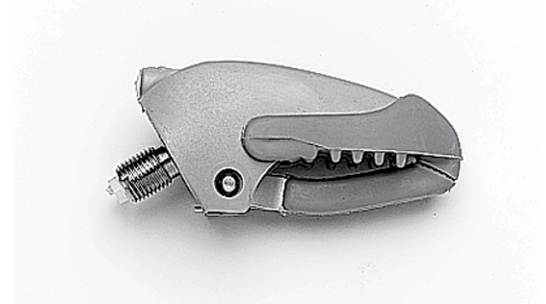

Description	Product No.
<b>Caucasian</b>	
Regular Spring	71620
Soft Spring	71630
Heavy Duty Spring	71633
<b>Dark Brown</b>	
Regular Spring	59321
Soft Spring	59322
Heavy Duty Spring	71634
Replacement Spring Kit	71632

### UCLA CAPP Delrin Body Friction Wrist

- These lightweight wrists incorporate a friction adjustment, which completely encircles the threaded interface of the terminal device and wrist, eliminating frequent changes in the friction setting

Description	Weight	Product No.
2" Diameter	1.5 oz	55110
1 <sup>3</sup> / <sub>4</sub> " Diameter	1.0 oz	55109
1 <sup>1</sup> / <sub>2</sub> " Diameter	.75 oz	55108



### Baby Mitt

- Soft foam passive hands
- Passive hand which allows the child to begin bi-manular activity, achieves body symmetry, helps to protect child during a fall, aids in standing or sitting balance, incorporation of the prosthesis in the body image
- Hands are available in two sizes for infants and toddlers, and two colors
- Does not require the addition of a cosmetic glove
- Standard 1/2"-20 thread stud



Hand Size	Length	MCP		Product No.	
		Circ.	with Thumb	Left	Right
<b>Caucasian</b>					
X-Small	3" (7.6 cm)	3 <sup>3</sup> / <sub>4</sub> " (9.5 cm)	5 <sup>1</sup> / <sub>8</sub> " (13 cm)	<b>50484</b>	<b>50483</b>
Small	3 <sup>1</sup> / <sub>4</sub> " (8.3 cm)	4 <sup>1</sup> / <sub>2</sub> " (11.4 cm)	5 <sup>3</sup> / <sub>4</sub> " (14.6 cm)	<b>50486</b>	<b>50485</b>
<b>Dark Brown</b>					
X-Small	3" (7.6 cm)	3 <sup>3</sup> / <sub>4</sub> " (9.5 cm)	5 <sup>1</sup> / <sub>8</sub> " (13 cm)	<b>59121</b>	<b>59120</b>
Small	3 <sup>1</sup> / <sub>4</sub> " (8.3 cm)	4 <sup>1</sup> / <sub>2</sub> " (11.4 cm)	5 <sup>3</sup> / <sub>4</sub> " (14.6 cm)	<b>59123</b>	<b>59122</b>

### Child CAPP Hand

- Soft, durable urethane cosmesis with life-like appearance
- More functional than most hands
- Adjustable spring tension
- Improved parent acceptance of cosmesis
- Does not require cosmetic glove
- Smooth, voluntary opening performance
- Standard 1/2"-20 thread stud



Color	Wrist to Finger Tip	Weight	Cable Exit	Product No.	
				Left	Right
Caucasian	3.3"	5.67 oz/ 161 g	Dorsal	<b>61826</b>	<b>61827</b>
Medium Brown	3.3"	5.67 oz/ 161 g	Dorsal	<b>61828</b>	<b>61829</b>
Dark Brown	3.3"	5.67 oz/ 161 g	Dorsal	<b>61830</b>	<b>61831</b>





### Child Dorrance 200 Mechanical Hand

- Dorrance hands provide voluntary opening of the thumb and first two fingers simultaneously
- Adjustable pinch force
- Breakaway release protects wearer if excessive force applied
- MCP circumference: 6<sup>1</sup>/<sub>2</sub>" (16.51 cm)
- Wrist to thumb tip: 3<sup>7</sup>/<sub>8</sub>" (9.8 cm)
- Weight: 9 oz (255 g)

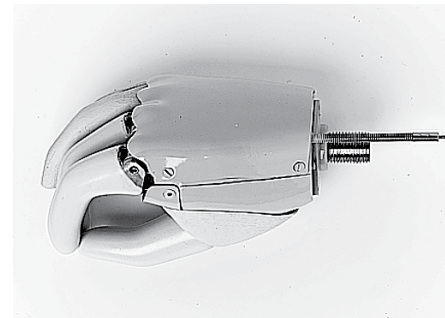

Description	Side	Glove No. (yyyyy)	Product No.
Dorrance Hand	Right	10204	50538
Dorrance Hand	Left	10203	50539
Replacement Spring, regular	—	—	55429
Replacement Spring, light	—	—	55430

**Glove Ordering Example**  
 Replace yyyyy with glove no.  
 Replace zz with color choice

Product No. . . . . 1yyyyyzz3  
 Glove No. . . . . 10204  
 Color . . . . . 01  
**110204013**

Gloves	
Description	Product No.
Micro Coated Vinyl	1yyyyyzz3
PVC	1yyyyyzz1
Expanded MCV	1yyyyyzz4
Hard PVC (light prosthesis)	2yyyyyzz1
Micro Coated Silicone	3yyyyyzz3
Silicone	3yyyyyzz1

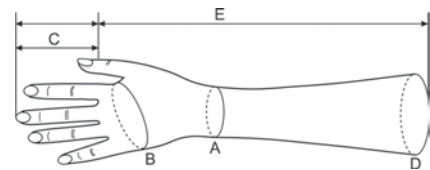

- A. Wrist circumference
- B. Metacarpal circumference
- C. Middle finger length
- D. Glove end circumference
- E. Length of glove

Please reference Hosmer swatch kit (56760) for color options (zz)									
01	02	03	04	05	06	07	08	09	
10	11	12	13	14	15	16	17	18	



## Child Passive Hand

- Soft foam passive hands available for either 1/2"-20 stud or M12 stud thread
- Passive hands positionable flexible fingers
- Reinforced hands have wired fingers attached to the wrist area
- Super reinforced hands have steel bars in the fingers that attach to the wrist area
- Hard PVC passive hands are a lightweight, cosmetically finished shell that slips over the residual limb and does not require a glove

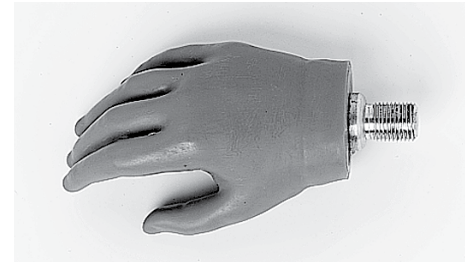

Hands	
Description	Product No.
Passive	5xxxxx000
Reinforced Passive	5xxxxx001
Super Reinforced Passive	5xxxxx002

**Hand Ordering Example**  
 Replace xxxxx with hand no.  
 Product No. . . . . 5xxxxx001  
 Hand No. . . . . 10901  
**510901001**

Gloves	
Description	Product No.
Micro Coated Vinyl	1yyyyyzz3
PVC	1yyyyyzz1
Expanded MCV	1yyyyyzz4
Hard PVC (light prosthesis)	2yyyyyzz1
Micro Coated Silicone	3yyyyyzz3
Silicone	3yyyyyzz1

**Glove Ordering Example**  
 Replace yyyyy with glove no.  
 Replace zz with color choice  
 Product No. . . . . 1yyyyyzz3  
 Glove No. . . . . 10902  
 Color. . . . . 01  
**110902013**

Please reference Hosmer swatch kit (56760) for color options (zz)									
01	02	03	04	05	06	07	08	09	
10	11	12	13	14	15	16	17	18	

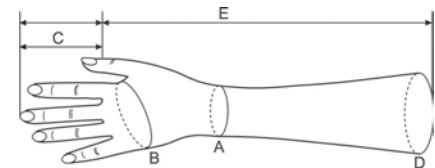

- A. Wrist circumference
- B. Metacarpal circumference
- C. Middle finger length
- D. Glove end circumference
- E. Length of glove

Measurements in mm					Size in inches	Approx. Age for use	Side	Hand No. (xxxxx)	Glove No. (yyyyy)
A	B	C	D	E					
100	100	40	140	152	4	0-18 mos	Left	N/A	10900L
100	100	40	133	151	4	0-18 mos	Right	N/A	10900R
115	115	45	150	173	4 <sup>1</sup> / <sub>2</sub>	1-3 yrs	Left	10901	10901
113	117	46	150	173	4 <sup>1</sup> / <sub>2</sub>	1-3 yrs	Right	10902	10902
113	123	47	150	186	5	3-6 yrs	Left	10903	10903
115	128	48	153	191	5	3-6 yrs	Right	10904	10904
128	150	58	175	218	5 <sup>3</sup> / <sub>4</sub>	5-9 yrs	Left	10905	10905
123	150	59	165	216	5 <sup>3</sup> / <sub>4</sub>	5-9 yrs	Right	10906	10906



### WE Friction Wrist

- Friction wrist control permits rotation of the terminal device to any position

Description	Diameter	Weight	Product No.
WE-200N Child Size	1 1/2"	1.5 oz	<b>52147</b>
WE-100N Infant Size	1 1/4"	1 oz	<b>52142</b>



### APRL Child Flexion Wrist (WF-50)

- Installs between terminal device and wrist allowing manual positioning of the terminal device
- Flexes at 0 and 36 degrees
- 1 1/16" (2.7 cm) long, 1.5 oz (42 g)
- Recommended for use with the WE-100N
- 1/2" - 20 thread and stub

Product No. **52176**



### E-50F Friction Elbow

- Friction elbows allow manual positioning of the forearm; friction is adjustable
- 2" diameter
- 7 oz weight

Product No. **50558**



### E-50 Elbow

- Child size mechanical elbow with 10 locking positions
- 2" (5.1 cm) diameter; 7.5 oz (210 g)
- 1 3/4" (4.4 cm) Elbow Axis to Socket End

Description	Product No.
E-50 Elbow with Outside Cable Exit	<b>50556</b>
E-50A Elbow with Inside Cable Exit	<b>50557</b>



**PC-50 Polycentric Below Elbow Hinge**

- Useful in compensating for excessive tissue in the cubital fold area
- Hinges are fabricated from special tool steel which is heat treated at the gear tooth ends for strength and then plated to prevent corrosion
- Small, 4.5 oz (126 g) pair

Product No. **51635**



**MA-50 Step Up Below Elbow Hinge**

- Intended for short, below elbow amputees who have a limited range of elbow flexion
- Multiplies the residual limb action of the forearm by a factor of 2
- Hinge is made of tool steel which is heat treated and plated for long life
- Small, 5 oz (140 g) pair

Product No. **51478**



**Northwestern Ring Harnesses**

- Fabricated with high grade dacron web tape, stainless steel anchor ring to prevent binding or bunching
- 4-bar buckles, axilla loop, Y strap and an anterior suspension
- Furnished ready to fit

**Below Elbow Prosthesis Harness**

- Child, 1/2" (1.3 cm)
- Med-Small, 3/4" (1.9 cm)

Description	Product No.
NRH-75 (child)	<b>51586</b>
NRH-85 (small-medium)	<b>51588</b>

**Above Elbow Prosthesis Harness**

- Child, 1/2" (1.3 cm)
- Med-Small, 3/4" (1.9 cm)

Description	Product No.
NRH-175 (child)	<b>51602</b>
NRH-185 (small-medium)	<b>51603</b>

